

EDCON-COMPONENTS



Contact



SPECIFICATION:

Materials:	Die-casting aluminium alloy
Color:	Alloy
Interlocking Components:	Stainless steel or galvanized steel button
Galvanized Steel:	IP65
Temperatur Range:	.-40°C to +125°C
Flammability acc:	VO (UL94)
Cable Entry:	both side
Lever:	one lever

Technical Drawing

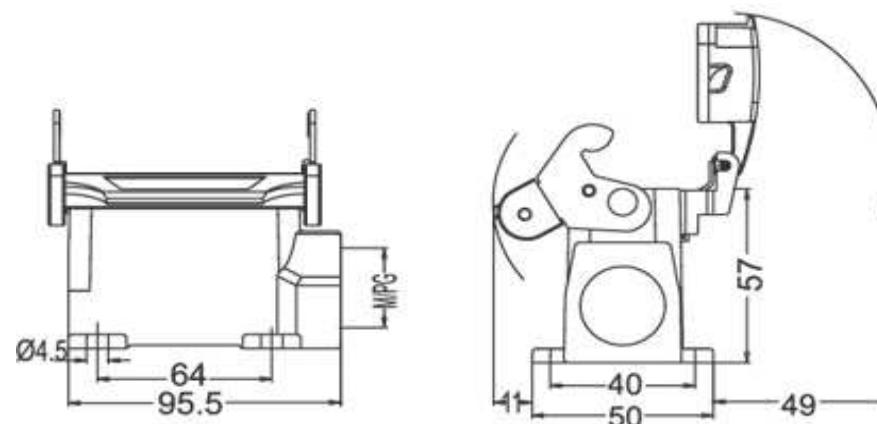

Heavy Connector Serie HD-025

Part No.: **0932007**

DRW:	Jason	CHKD	Wilson	MATL:	Wilson	TOLERANCE	Mason	DATE	16.08.2010
APPD:	Schumi			FINISH	Jamy		Sheet No.	1 from 2	Customer:

www.edcon-components.com

email: info@edcon-components.com

EDCON-COMPONENTS



Contact



Ordering Informations

Serie	Thread Type	Size of Thread	ROHS	Packing						
0932007	X	XX	R	CA						

		R= ROHS Conform	CA= Carton				
M= M-Thread	20 = M20	N= NON ROHS Conform					
P= PG Thread	220 = 2xM20						
	25 = M25						
	225 = 2xM25						
	16 = PG16						
	216 = 2xPG16						
	21 = PG21						

Heavy Connector Serie HD-025
Part No.: 0932007
Customer:

DRW:	Jason	CHKD	Wilson	MATL:	Wilson	TOLERANCE	Mason	DATE	16.08.2010
APPD:	Schumi			FINISH	Jamy		Sheet No.		2 from 2