

# EDCON-COMPONENTS



**Contact**



## SPECIFICATION:

Materials:	Die-casting aluminium alloy
Color:	Alloy
Interlocking Components:	Stainless steel or galvanized steel button
Galvanized Steel:	IP65
Temperatur Range:	.-40°C to +125°C
Flammability acc:	VO (UL94)
Cable Entry:	on top side
Lever:	no lever

## Technical Drawing

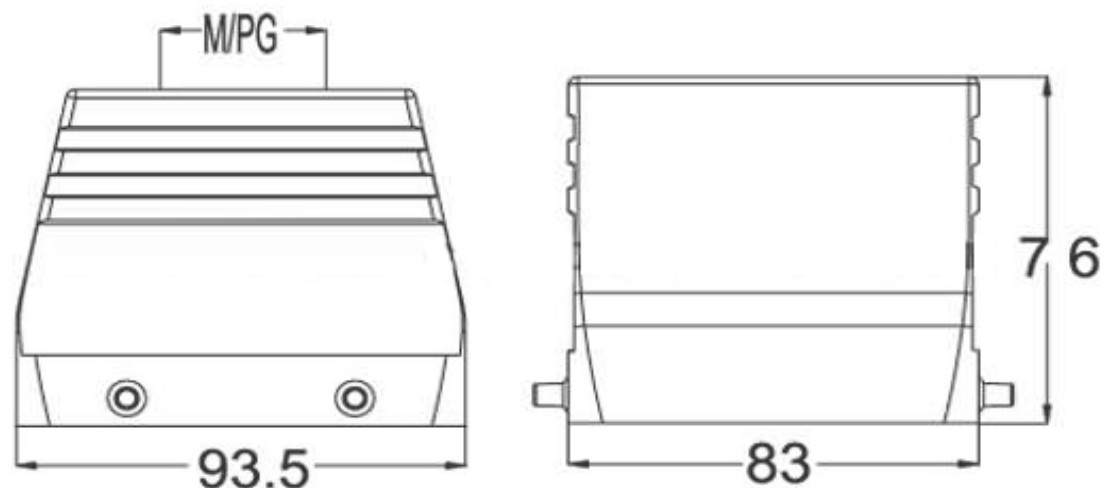

**Heavy Connector Hood  
Serie HEE-64**

Part No.: **0927005**

DRW:	Jason	CHKD	Wilson	MATL:	Wilson	TOLERANCE	Mason	DATE	16.08.2010
APPD:	Schumi			FINISH	Jamy		Sheet No.	1 from 2	Customer:

[www.edcon-components.com](http://www.edcon-components.com)

email: [info@edcon-components.com](mailto:info@edcon-components.com)

# EDCON-COMPONENTS



**Contact**



## Ordering Informations

Serie	Thread Type	Size of Thread	ROHS	Packing						
<b>0927005</b>	<b>X</b>	<b>XX</b>	<b>R</b>	<b>CA</b>						

		R= ROHS Conform	CA= Carton						
M= M-Thread	32 = M32	N= NON ROHS Conform							
P= PG Thread	40 = M40								
	29 = PG29								
	36 = PG36								

<b>Heavy Connector Hood Serie HEE-64</b>
Part No.: <b>0927005</b>
Customer:

DRW:	Jason	CHKD	Wilson	MATL:	Wilson	TOLERANCE	Mason	DATE	16.08.2010
APPD:	Schumi			FINISH	Jamy			Sheet No.	2 from 2