

EDCON-COMPONENTS



Contact



SPECIFICATION:

Materials:	Die-casting aluminium alloy
Color:	Alloy
Interlocking Components:	Stainless steel or galvanized steel button
Galvanized Steel:	IP65
Temperatur Range:	.-40°C to +125°C
Flammability acc:	VO (UL94)
Cable Entry:	panel side
Lever:	one lever

Technical Drawing

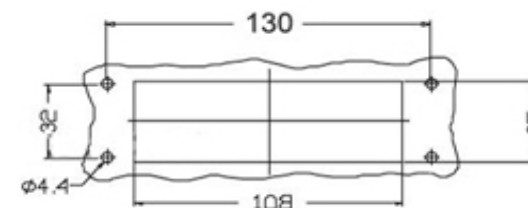
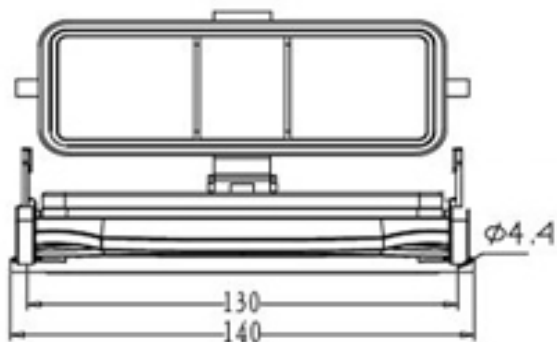
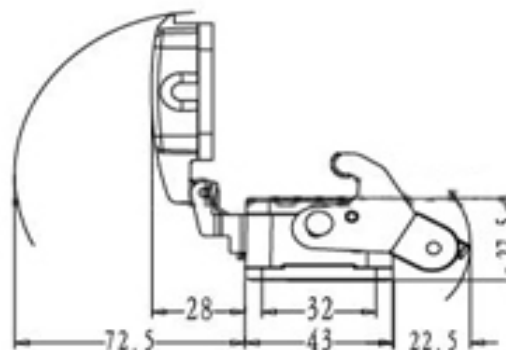

Panel cut out

**Heavy Connector Serie
HEE-46**

Part No.: **0926017**

DRW:	Jason	CHKD	Wilson	MATL:	Wilson	TOLERANCE	Mason	DATE	16.08.2010	Customer:
APPD:	Schumi			FINISH	Jamy		Sheet No.	1 from 2		

www.edcon-components.com

email: info@edcon-components.com

EDCON-COMPONENTS



Contact



Ordering Informations

Serie	Thread Type	Size of Thread	ROHS	Packing						
0926017	X	XX	R	CA						

X= No function	XX= No function	R= ROHS Conform	CA= Carton						
		N= NON ROHS Conform							

Heavy Connector Serie HEE-46	
Part No.:	0926017
Customer:	

DRW:	Jason	CHKD	Wilson	MATL:	Wilson	TOLERANCE	Mason	DATE	16.08.2010
APPD:	Schumi			FINISH	Jamy			Sheet No.	2 from 2