

EDCON-COMPONENTS



Contact



SPECIFICATION:

Materials:	Die-casting aluminium alloy
Color:	Alloy
Interlocking Components:	Stainless stell or galvanized steel button
Galvanized Steel:	IP65
Temperatur Range:	.-40°C to +125°C
Flammability acc:	VO (UL94)
Cable Entry:	one top side
Lever:	no lever

Technical Drawing

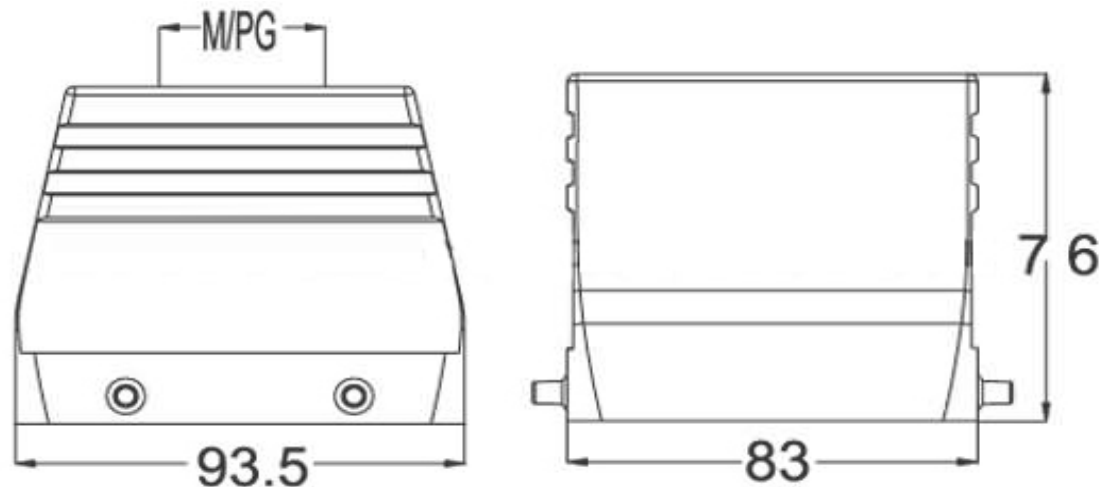

Heavy Connector Hood Serie HE-032

Part No.: **0921005**

DRW:	Jason	CHKD	Wilson	MATL:	Wilson	TOLERANCE	Mason	DATE	16.08.2010
APPD:	Schumi			FINISH	Jamy		Sheet No.	1 from 2	Customer:

www.edcon-components.com

email: info@edcon-components.com

EDCON-COMPONENTS



Contact



Ordering Informations

Serie	Thread Type	Size of Thread	ROHS	Packing						
0921005	X	XX	R	CA						

		R= ROHS Conform	CA= Carton						
M= M-Thread	32 = M32	N= NON ROHS Conform							
P= PG Thread	40 = M40								
	29= PG29								
	36= PG36								

Heavy Connector Hood Serie HE-032	
Part No.:	0921005
Customer:	

DRW:	Jason	CHKD	Wilson	MATL:	Wilson	TOLERANCE	Mason	DATE	16.08.2010
APPD:	Schumi			FINISH	Jamy		Sheet No.		2 from 2