

EDCON-COMPONENTS



Contact



SPECIFICATION:

Materials:	Die-casting aluminium alloy
Color:	Alloy
Interlocking Components:	Stainless stell or galvanized steel button
Galvanized Steel:	IP65
Temperatur Range:	.-40°C to +125°C
Flammability acc:	VO (UL94)
Mounting:	Panel Type

Technical Drawing

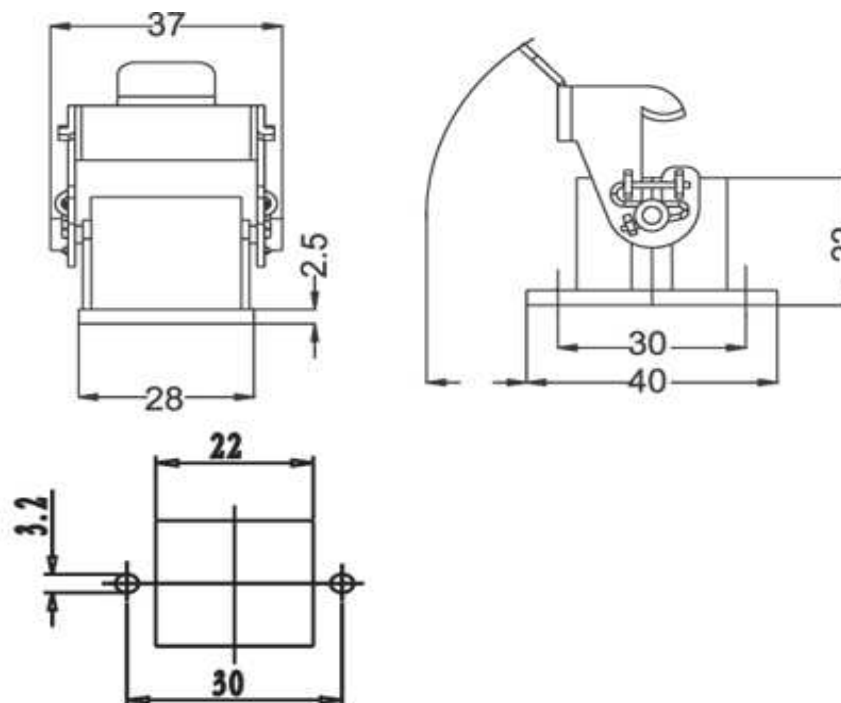

Heavy Connector Hood Serie 0911

Part No.: **0911007**

Customer:

DRW:	Jason	CHKD	Wilson	MATL:	Wilson	TOLERANCE	Mason	DATE	01.08.2009
APPD:	Schumi			FINISH	Jamy		Sheet No.		1 from 2

www.edcon-components.com

email: info@edcon-components.com

EDCON-COMPONENTS



Contact



Ordering Informations

Serie	Thread Type	Size of Thread	ROHS	Packing						
0911007	X	XX	R	CA						

X= No function	XX= No function	R= ROHS Conform	CA= Carton				
		N= NON ROHS Conform					

Heavy Connector Hood Serie 0911	
Part No.:	0911007
Customer:	

DRW:	Jason	CHKD	Wilson	MATL:	Wilson	TOLERANCE	Mason	DATE	02.02.2008
APPD:	Schumi			FINISH	Jamy		Sheet No.		2 from 2