

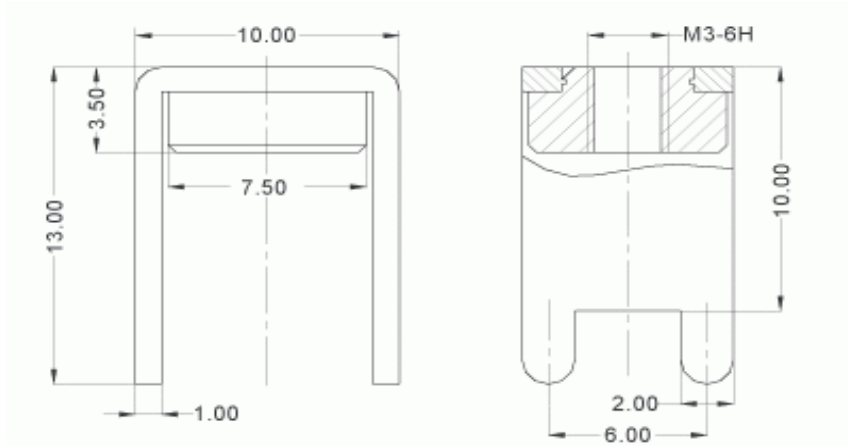

Technical Dimension



Material

Material: Brass, Tin plated
 Center Space: 6,00mm
 Screw: M3
 Material Screw: Steel Nickel Plated
 Screw Torque: 8 lbf-in
 Rated Current: 60A

Ordering Information

Serie	ROHS	Packing				
A25005	R	BU102				

R= ROHS Conform	BU102= Bulk Ware 1000PCS
N= NON ROHS	

PCB Power Terminal	
Part No.:	A25005
Customer:	

DRW:	Jason	CHKD	Jules	MATL:	Wu	DATE	06.06.2009
APPD:	Join			FINISH	Shieh	Sheet	1 from 1