



# DATA SHEET

## 100Watt High Power LED Standard Voltage

**Serie: M15019**

Wavelength **3300= 3300K**

Brightness **5650= 5650lm**

Color: **WW= Warm White**

**100Watt High Power LED  
Standard Voltage**

Serie No.: **M15019**

Customer:

DRW:	Jason	CHKD	Wilson	MATL:	Wilson	TOLERANCE	Mason	DATE	20.01.2011
APPD:	Schumi			FINISH	Jamy		Sheet No.		1 from 14

# EDCON-COMPONENTS



## Technical Dimensions

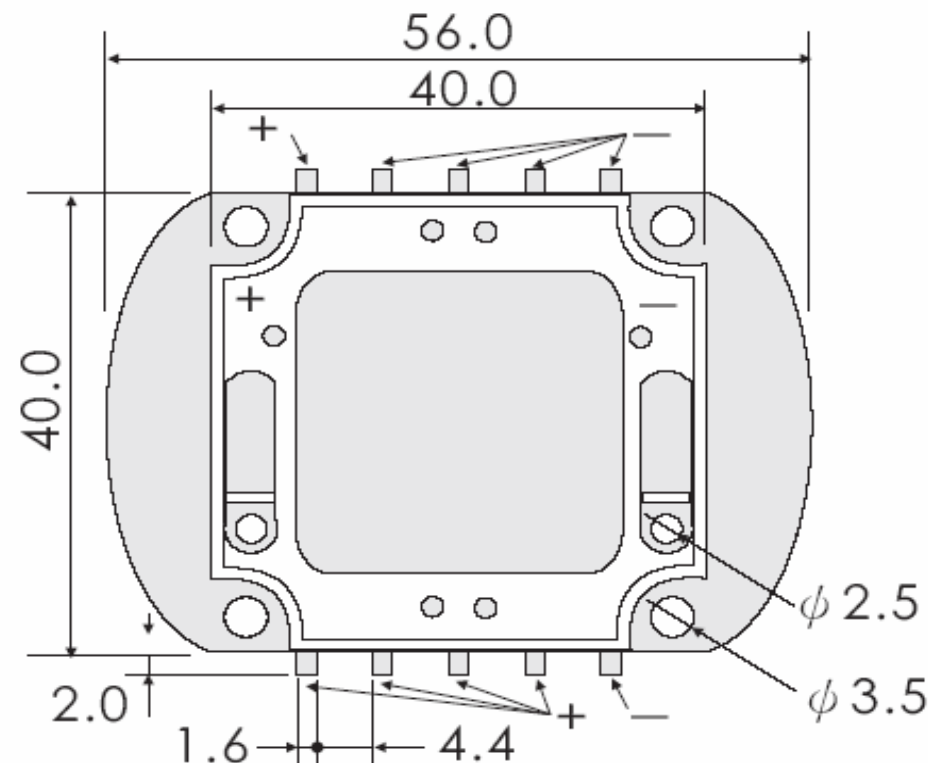
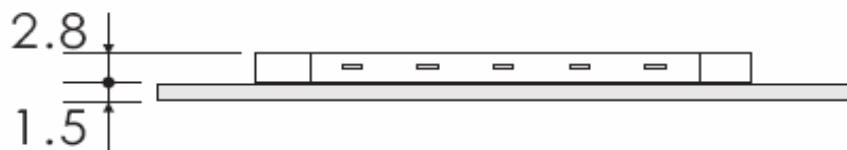

1. All Dimensions are in mm.
2. Lead Spacing in measurement where the lead emerge from the package
3. Protruded resin under flange is 1,5mm max.
4. Tolerance are 0,3mm unless otherwise noted.
5. Specifications are subject to change without notice
6. Driving LED without heat sinking device is forbidden
7. Warps the degree 0,5mm
8. Leds are not designed must to be driven in reverse bias.
9. Proper current derating must be observed to maintain junction temperature below the maximum
10. It is strongly recommended that the temperature of lead be not higher than 55°C.

**100Watt High Power LED  
Standard Voltage**

Part No.: **M15019**

Customer:

DRW:	Jason	CHKD	Wilson	MATL:	Wilson	TOLERANCE	Mason	DATE	20.01.2011
APPD:	Schumi			FINISH	Jamy		Sheet No.	2 from 14	

# EDCON-COMPONENTS



## Features

- Long operating life
- Instant Light
- Superior ESD defense
- Low Voltage DC operated
- Color bright saturated
- More energy efficient than incandescent and most halogen lamps

## Discription

**EDCON-COMPONENTS High Power LED is make of hi-eff AS/TS GaInN chips with precide package technique which makes excellent heat dissipation to reach the advantages of high lunious efficiency, low decay, and long endurance. Now we have these colors available RED, GREEN, BLU, YELLOW, WHITE.**

## Typical Applications

- Decoration Lights
- Beacon light
- Bathrooms Light
- Medical applications
- Architectural detail lighting

**100Watt High Power LED  
Standard Voltage**

Part No.: **M15019**

DRW:	Jason	CHKD	Wilson	MATL:	Wilson	TOLERANCE	Mason	DATE	20.01.2011	Customer:
APPD:	Schumi			FINISH	Jamy		Sheet No.	3 from 14		

[www.edcon-components.com](http://www.edcon-components.com)

email: [info@edcon-components.com](mailto:info@edcon-components.com)

# EDCON-COMPONENTS



## Absolute Maximum Ratings

Parameter	Symbol	Max. Rating	Unit
Continuous Forward Current	IF	2850	mA
Peak Forward Current *1	IFM	3000	mA
Electrostatic Discharge (HBM)	ESD	4000	V
LED Junction Temperature	Tj	135	°C
Operating Temperature	Topr	-40 ~ +110	°C
Storage Temperature	Tstg	-40 ~ +120	°C

Manual Soldering Temperature 260°C for 5seconds max . 2

TA=25°C

\*1 Duty Ratio = 00,1%, Pulse Width=10us.

\*2 Iron soldering high temperature will not cause damage to the dice. But be aware of the high temperature will make the epoxy soften and the gold wire broken and even open. So before returning to the normal temperatures please avoid any serious pressure on the top of epoxy and lead.

\*3. We suggest using PWM ( Pulse Width Modulation) for driving.

\*4 It is recommended to use series as there are several 3pcs. If there are more than 5pcs, please use product with higher power.

## Electrical- Optical Characteristics

Parameter	Symbol	Test Cond.	Min	Typ	Max.	Unit
View Angle of Half Power	2Ø1/2	IF=2800mA		120		deg.
Forward Voltage	VF			35	38	V
Color Rendering Index for 3300K	CRI			90		
Thermal Resistance Junction to Case	RØ J-C			0,8		°C/W
Temperature Coefficient of Forward Voltage	Δ Vf/Δ T			-.2		mV/°C

TA=25°C

**100Watt High Power LED  
Standard Voltage**

Part No.: **M15019**

DRW:	Jason	CHKD	Wilson	MATL:	Wilson	TOLERANCE	Mason	DATE	20.01.2011	Customer:
APPD:	Schumi			FINISH	Jamy		Sheet No.	4 from 14		

[www.edcon-components.com](http://www.edcon-components.com)

email: info@edcon-components.com

# EDCON-COMPONENTS



## Electrical Optical Characteristics for Luminous Intensity

## Electrical-Optical Characteristics for Wavelength

Emitting Color	Symbol	Test Cond.	Min	Typ	Unit
Warm White 1	VF	IF=2800mA		5850	lm
Warm White 2				6480	
Warm White 3				6850	
Warm White 4				7250	
Warm White 5				4825	
Warm White 6				5345	
Warm White 7				5650	
Warm White 8				5980	

## Endurance Test

Test Item	Reference Standard	Test Conditions	Result
Operating Life	MIL-STD-750:1026 MIL-STD-883:1005 JIS-C-7021: B-1	Connect with a power if=2800mA Ta=Under room temperature Trest Time = 1000hrs	0/22
High Temperature High Humidity Storage	MIL-STD-202:103B JIS-C-7021: B-11	Ta= +85°C +/-5°C RH=80% ~ 85% Test Time = 1000hrs	0/22
High Temperature Storage	MIL-STD-883:1008 JIS-C-7021: B-10	High Ta= +120°C +/- 5°C Test Time= 1000hrs	0/22
Low Temperature Storage	JIS-C-7021: B-12	Low Ta= 40°C +/-5°C Test Time= 1000hrs	0/22

### Failure Criteria:

1. VF arise ≥10%
2. IV decline ≥30%
3. A failure is an LED that is open or shorted

Tolerance: 15% of EDCON- measuring equipments: EXELTRON  
2001.2.S370 made by U.D.T:

TA=25°C

**100Watt High Power LED  
Standard Voltage**

Part No.: **M15019**

DRW:	Jason	CHKD	Wilson	MATL:	Wilson	TOLERANCE	Mason	DATE	20.01.2011	Customer:
APPD:	Schumi			FINISH	Jamy		Sheet No.	5 from 14		

[www.edcon-components.com](http://www.edcon-components.com)

email: info@edcon-components.com

# EDCON-COMPONENTS



## Color Range and Bin Selection

CCT (K) TYP	Chromaticity Coordinates						
	3300	x	0,402	0,454	0,429	0,416	0,410
y		0,423	0,446	0,394	0,389	0,374	0,360
Tolerance		X +/-0,02			Y +/-0,02		

## Cool White CIE Light Color Chart

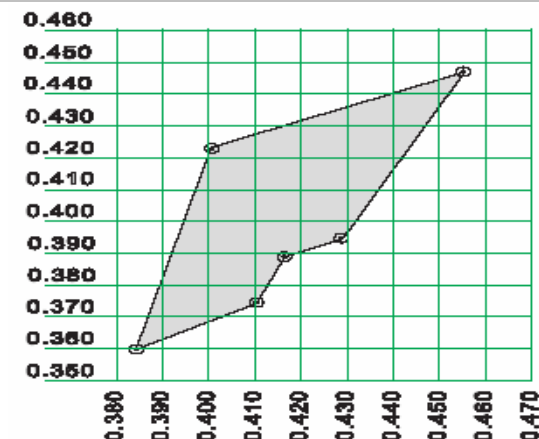

Color Temperature	Lens Color	Dice Source	Color (K)
Warm White 1	Yellow Diffused	GaInN/GaN	3300
Warm White 2			
Warm White 3			
Warm White 4			
Warm White 5			
Warm White 6			
Warm White 7			
Warm White 8			

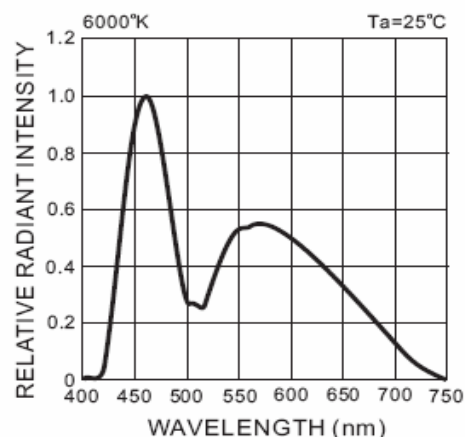

## Environmental Test

Test Item	Reference Standard	Test Conditions	Result
Temperature Cycling	MIL-STD-202:107D MIL-STD-750:1051 MIL-STD-833:1010 JIS-C-7021: A4	-.40°C ~ +25°C ~ +85°C ~ +25°C 60min 20min 60min 20min Test Time= 200cycles	0/22
Thermal Shock	MIL-STD-202:107D MIL-STD-750:1051 MIL-STD-833:1010	-.40°C +/- 5°C ~ +110°C +/-5°C 20min 20min. Test Time= 200cycles	0/22

### Failure Criteria:

- VF arise ≥10%
- IV decline ≥30%
- A failure is an LED that is open or shorted

**100Watt High Power LED  
Standard Voltage**

Part No.: **M15019**

DRW:	Jason	CHKD	Wilson	MATL:	Wilson	TOLERANCE	Mason	DATE	20.01.2011	Customer:
APPD:	Schumi			FINISH	Jamy		Sheet No.	6 from 14		

# EDCON-COMPONENTS



## Typical Electrical Optical Characteristics Curves

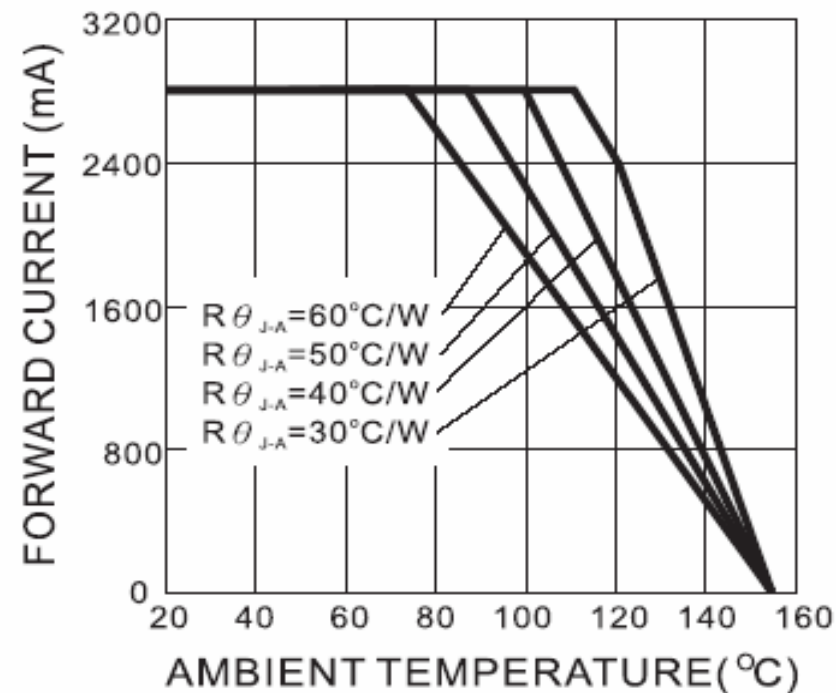
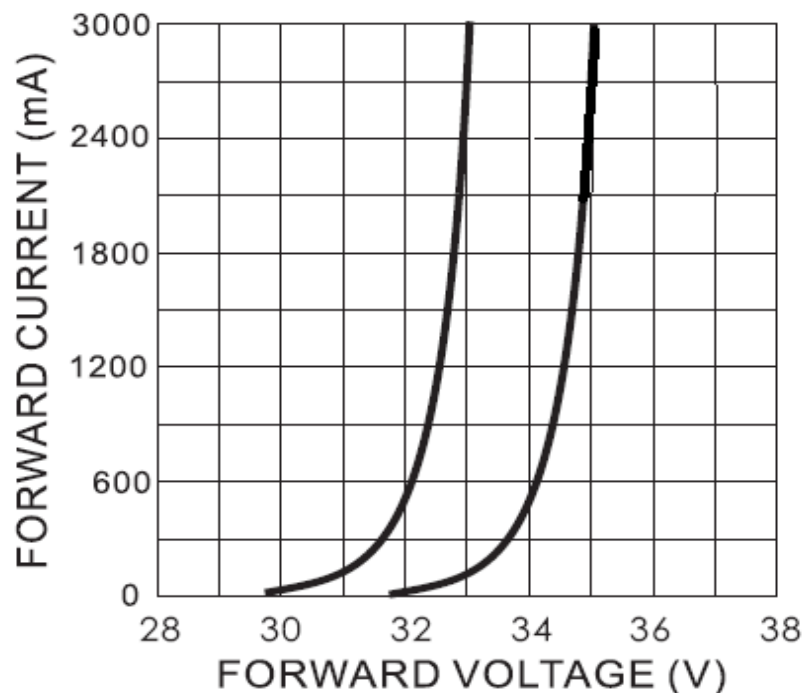

**100Watt High Power LED  
Standard Voltage**

Part No.: **M15019**

Customer:

DRW:	Jason	CHKD	Wilson	MATL:	Wilson	TOLERANCE	Mason	DATE	20.01.2011
APPD:	Schumi			FINISH	Jamy		Sheet No.	7 from 14	

[www.edcon-components.com](http://www.edcon-components.com)

email: [info@edcon-components.com](mailto:info@edcon-components.com)

# EDCON-COMPONENTS



## Typical Electrical Optical Characteristics Curves

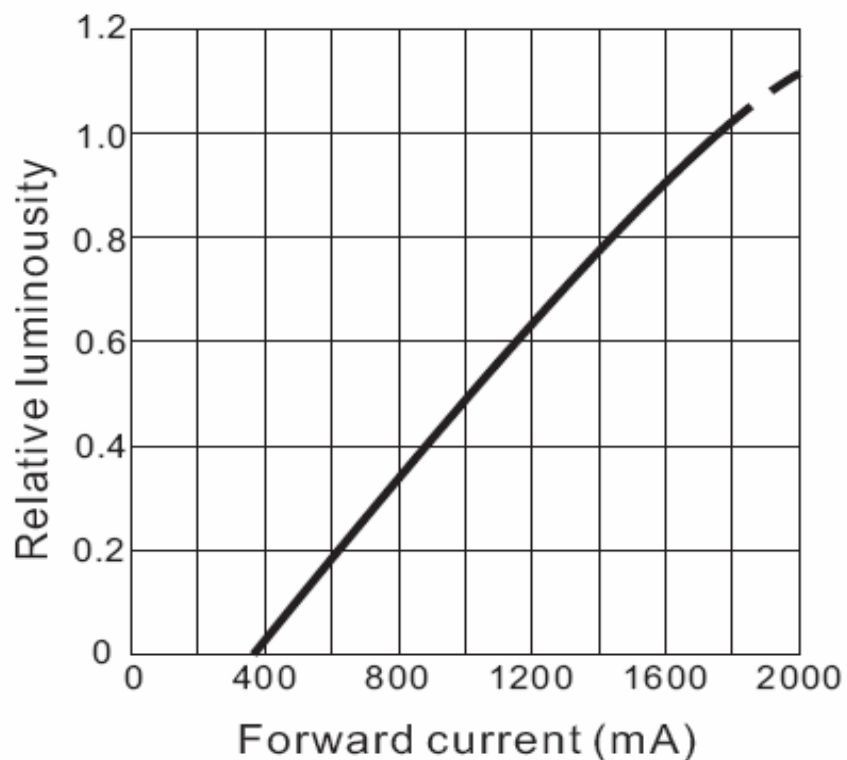

**100Watt High Power LED  
Standard Voltage**

Part No.: **M15019**

DRW:	Jason	CHKD	Wilson	MATL:	Wilson	TOLERANCE	Mason	DATE	20.01.2011
APPD:	Schumi			FINISH	Jamy		Sheet No.	8 from 14	Customer:



# EDCON-COMPONENTS



## Typical Electrical Optical Characteristics Curves

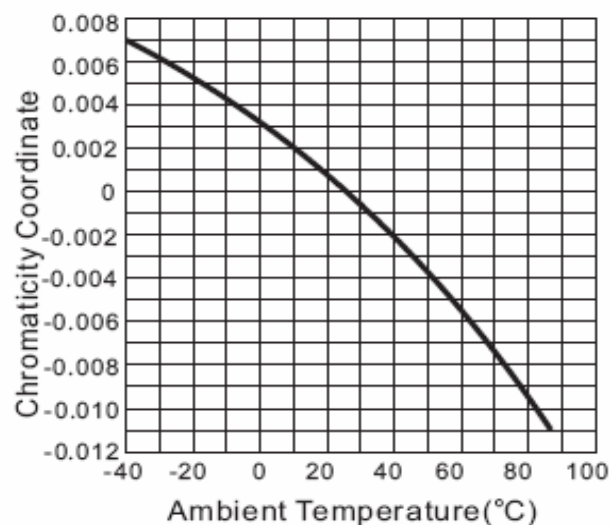
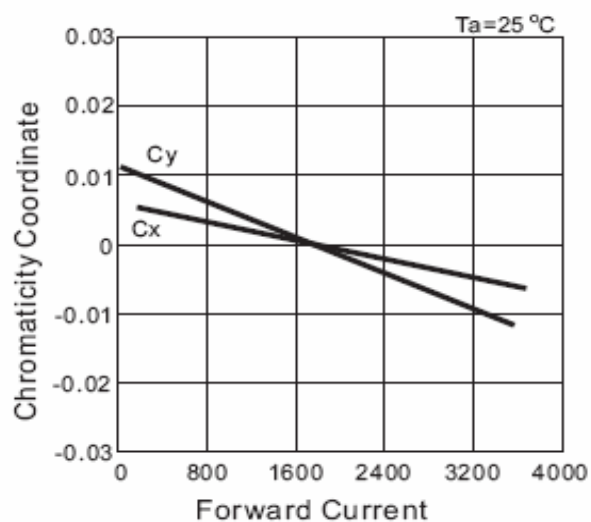

**100Watt High Power LED  
Standard Voltage**

Part No.: **M15019**

DRW:	Jason	CHKD	Wilson	MATL:	Wilson	TOLERANCE	Mason	DATE	20.01.2011
APPD:	Schumi			FINISH	Jamy		Sheet No.	9 from 14	Customer:

[www.edcon-components.com](http://www.edcon-components.com)

email: [info@edcon-components.com](mailto:info@edcon-components.com)



Mounting Explanation

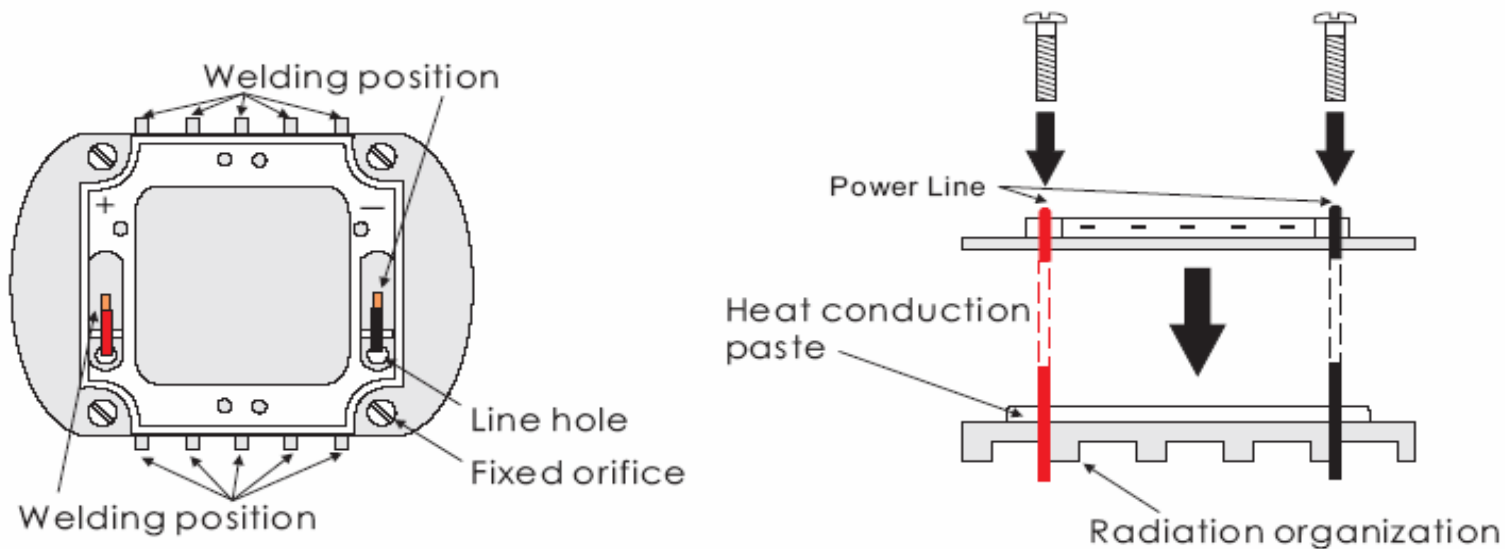

EDCON-COMPONENTS provide simple comparison table for High Power LED, you could find your request heat dissipation area from the following table.

<b>100Watt High Power LED Standard Voltage</b>	
Part No.:	<b>M15019</b>
Customer:	

DRW:	Jason	CHKD	Wilson	MATL:	Wilson	TOLERANCE	Mason	DATE	20.01.2011
APPD:	Schumi			FINISH	Jamy		Sheet No.	10 from 14	

# EDCON-COMPONENTS



## Conclusion

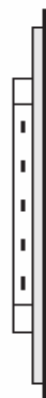

Free Convection Horizontal	
Flat Heat Dissipation Set-up	
(Area Require mm <sup>2</sup> )	
White	107,000

Free Convection Vertical	
Flat Heat Dissipation Set-up	
(Area Require mm <sup>2</sup> )	
White	79,500

Free Convection	
Finned Heat dissipation Set-up	
(Area Require mm <sup>2</sup> )	
White	371,000

TAB in this table is according to highest operating temperature 65°C

Different materials of second heat dissipation device, the surface area of heat sink will be different. Thus, this document is for reference only.

**100Watt High Power LED  
Standard Voltage**

Part No.: **M15019**

DRW:	Jason	CHKD	Wilson	MATL:	Wilson	TOLERANCE	Mason	DATE	20.01.2011
APPD:	Schumi			FINISH	Jamy		Sheet No.	11 from 14	Customer:

[www.edcon-components.com](http://www.edcon-components.com)

email: [info@edcon-components.com](mailto:info@edcon-components.com)

# EDCON-COMPONENTS



## Operating Instructions



It is important to keep away the product from the water, in order to avoid the product electronic characteristics to be harmful



Above 150°C



There is 150°C directly from the front of Power LED emitting diode. It is untouchable to prevent burning.

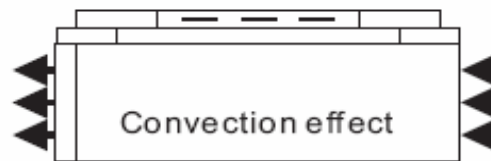

It should be noticed whether there is convection in design of device. Convection has to exist.



The material in the central top of POWER LED is soft. Therefore, it is un squeezable and untouchable.



Keep Insulation



Power Supply

In the button of heat sink cannot be touched with neither positive nor negative pole. ( Heat sink has to be insulation)



When making use of products, it is necessary to use anti ESD devices to prevent destructive electronic characteristics.

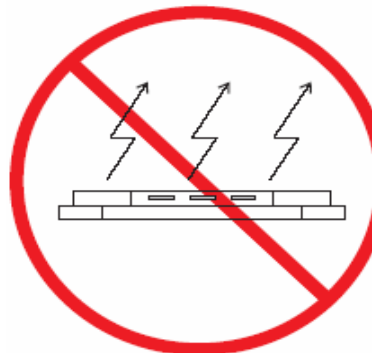

The product should not be light up directly without heat dissipation device

**100Watt High Power LED  
Standard Voltage**

Part No.: **M15019**

DRW:	Jason	CHKD	Wilson	MATL:	Wilson	TOLERANCE	Mason	DATE	20.01.2011
APPD:	Schumi			FINISH	Jamy		Sheet No.	12 from 14	Customer:

[www.edcon-components.com](http://www.edcon-components.com)

email: [info@edcon-components.com](mailto:info@edcon-components.com)

# EDCON-COMPONENTS



## TAB Temperature LIFE Characteristics Curve

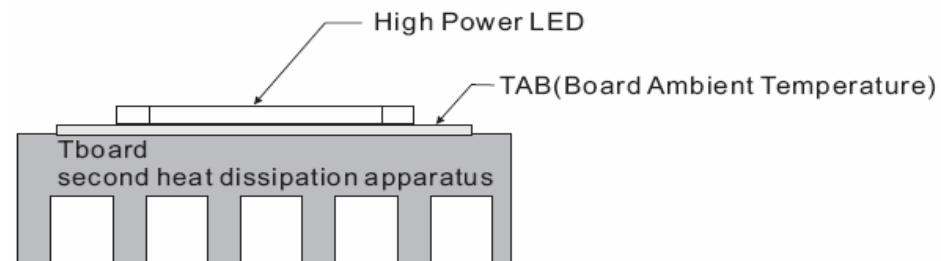

Board Ambient Temperature Tolerance 5°C  
 TAB in this table is according to highest operating temperature 65°C  
 The TAB is the stable testing value for the product lighted 100% after one hour  
 Different materials of second heat dissipation device, the surface area of heat sink will be different,  
 Thus, this document is for reference only.

**100Watt High Power LED  
 Standard Voltage**

Part No.: **M15019**

DRW:	Jason	CHKD	Wilson	MATL:	Wilson	TOLERANCE	Mason	DATE	20.01.2011
APPD:	Schumi			FINISH	Jamy		Sheet No.	13 from 14	Customer:

# EDCON-COMPONENTS



## Ordering Informations

Serie	Emitting Color	(Kelvin)	Brightness	ROHS	Packing Code					
-------	----------------	----------	------------	------	--------------	--	--	--	--	--

<b>M15019</b>	<b>WW</b>	<b>3300</b>	<b>5650</b>	<b>R</b>	<b>BU</b>					
---------------	-----------	-------------	-------------	----------	-----------	--	--	--	--	--

<b>WW=</b> Warm White	<b>3300=</b> 3300K	<b>5650=</b> 5650lm	<b>R=</b> ROHS Conform	<b>BU=</b> Bulk Ware		
			<b>N=</b> NON ROHS Conform	<b>TY=</b> Tray Packing		

**100Watt High Power LED  
Standard Voltage**

Part No.: **M15019**

DRW:	Jason	CHKD	Wilson	MATL:	Wilson	TOLERANCE	Mason	DATE	20.01.2011
APPD:	Schumi			FINISH	Jamy			Sheet No.	14 from 14

Customer: