



DATA SHEET

50Watt High Power LED Standard Voltage

Serie: M15018

Wavelength **6000= 6000K**

Brightness **3735= 3735lm**

Color: **PW= Pure White**

**50Watt High Power LED
Standard Voltage**

Serie No.: **M15018**

Customer:

DRW:	Jason	CHKD	Wilson	MATL:	Wilson	TOLERANCE	Mason	DATE	05.01.2011
APPD:	Schumi			FINISH	Jamy		Sheet No.	1 from 14	

EDCON-COMPONENTS



Technical Dimensions

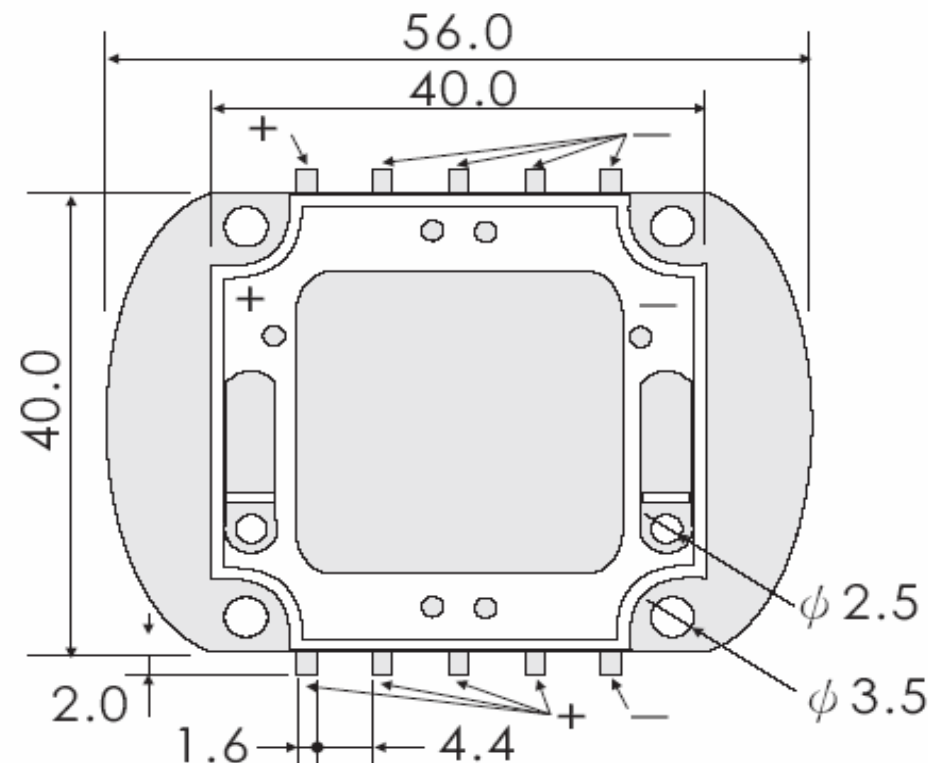
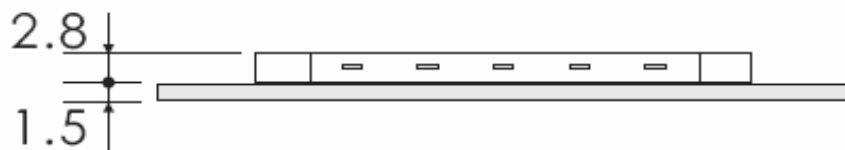

1. All Dimensions are in mm.
2. Lead Spacing in measurement where the lead emerge from the package
3. Protruded resin under flange is 1,5mm max.
4. Tolerance are 0,3mm unless otherwise noted.
5. Specifications are subject to change without notice
6. Driving LED without heat sinking device is forbidden
7. Warps the degree 0,5mm
8. Leds are not designed must to be driven in reverse bias.
9. Proper current derating must be observed to maintain junction temperature below the maximum
10. It is strongly recommended that the temperature of lead be not higher than 55°C.

**50Watt High Power LED
Standard Voltage**

Part No.: **M15018**

Customer:

DRW:	Jason	CHKD	Wilson	MATL:	Wilson	TOLERANCE	Mason	DATE	05.01.2011
APPD:	Schumi			FINISH	Jamy		Sheet No.	2 from 14	

EDCON-COMPONENTS



Features

Long operating life
 Instant Light
 Superior ESD defense
 Low Voltage DC operated
 Color bright saturated
 More energy efficient than incandescent and most halogen lamps

Discription

EDCON-COMPONENTS High Power LED is make of hi-eff AS/TS GaInN chips with precide package technique which makes excellent heat dissipation to reach the advantages of high lunious efficiency, low decay, and long endurance. Now we have these colors available RED, GREEN, BLU, YELLOW, WHITE.

Typical Applications

Decoration Lights
 Beacon light
 Bathrooms Light
 Medical applications
 Architectural detail lighting

**50Watt High Power LED
 Standard Voltage**

Part No.: **M15018**

DRW:	Jason	CHKD	Wilson	MATL:	Wilson	TOLERANCE	Mason	DATE	05.01.2011
APPD:	Schumi			FINISH	Jamy		Sheet No.	3 from 14	

Customer:

EDCON-COMPONENTS



Absolute Maximum Ratings

Parameter	Symbol	Max. Rating	Unit
Continuous Forward Current	IF	1750	mA
Peak Forward Current *1	IFM	2000	mA
Electrostatic Discharge (HBM)	ESD	4000	V
LED Junction Temperature	Tj	135	°C
Operating Temperature	Topr	-40 ~ +110	°C
Storage Temperature	Tstg	-40 ~ +120	°C

Manual Soldering Temperature 260°C for 5seconds max . 2

TA=25°C

*1 Duty Ratio = 00,1%, Pulse Width=10us.

*2 Iron soldering high temperature will not cause damage to the dice. But be aware of the high temperature will make the epoxy soften and the gold wire broken and even open. So before returning to the normal temperatures please avoid any serious pressure on the top of epoxy and lead.

*3. We suggest using PWM (Pulse Width Modulation) for driving.

*4 It is recommended to use series as there are several 3pcs. If there are more than 5pcs, please use product with higher power.

Electrical- Optical Characteristics

Parameter	Symbol	Test Cond.	Min	Typ	Max.	Unit
View Angle of Half Power	2Ø1/2	IF=1750mA		120		deg.
Forward Voltage	VF			27	31	V
Color Rendering Index for 4000K	CRI			75		
Color Rendering Index for 3300K	CRI			70		
Thermal Resistance Junction to Case	RØ J-C				1,5	°C/W
Temperature Coefficient of Forward Voltage	Δ Vf/Δ T				-.2	mV/°C

TA=25°C

**50Watt High Power LED
Standard Voltage**

Part No.: **M15018**

DRW:	Jason	CHKD	Wilson	MATL:	Wilson	TOLERANCE	Mason	DATE	05.01.2011	Customer:
APPD:	Schumi			FINISH	Jamy		Sheet No.	4 from 14		

www.edcon-components.com

email: info@edcon-components.com

EDCON-COMPONENTS



Electrical Optical Characteristics for Luminous Intensity

Emitting Color	Symbol	Test Cond.	Min	Typ	Unit
Pure White 1	VF	IF=1750mA		3250	lm
Pure White 2				3735	
Pure White 3				4100	
Pure White 4				4340	

Electrical-Optical Characteristics for Wavelength

Endurance Test

Test Item	Reference Standard	Test Conditions	Result
Operating Life	MIL-STD-750:1026 MIL-STD-883:1005 JIS-C-7021: B-1	Connect with a power if=1750mA Ta=Under room temperature Trest Time = 1000hrs	0/22
High Temperature High Humidity Storage	MIL-STD-202:103B JIS-C-7021: B-11	Ta= +85°C +/-5°C RH=80% ~ 85% Test Time = 1000hrs	0/22
High Temperature Storage	MIL-STD-883:1008 JIS-C-7021: B-10	High Ta= +120°C +/- 5°C Test Time= 1000hrs	0/22
Low Temperature Storage	JIS-C-7021: B-12	Low Ta= 40°C +/-5°C Test Time= 1000hrs	0/22

Failure Criteria:

1. VF arise $\geq 10\%$
2. IV decline $\geq 30\%$
3. A failure is an LED that is open or shorted

Tolerance: 15% of EDCON- measuring equipments: EXELTRON
2001.2.S370 made by U.D.T:

TA=25°C

**50Watt High Power LED
Standard Voltage**

Part No.: **M15018**

DRW:	Jason	CHKD	Wilson	MATL:	Wilson	TOLERANCE	Mason	DATE	05.01.2011	Customer:
APPD:	Schumi			FINISH	Jamy		Sheet No.	5 from 14		

www.edcon-components.com

email: info@edcon-components.com

EDCON-COMPONENTS



Color Range and Bin Selection

CCT (K) TYP	Chromaticity Coordinates				
	6000	x	0,301	0,329	0,329
y		0,342	0,369	0,310	0,293
Tolerance	X +/-0,02		Y +/-0,02		

Color Temperature	Lens Color	Dice Source	Color (K)
Pure White 1	White Diffusion	GaInN/GaN	6000
Pure White 2			
Pure White 3			
Pure White 4			

Cool White CIE Light Color Chart

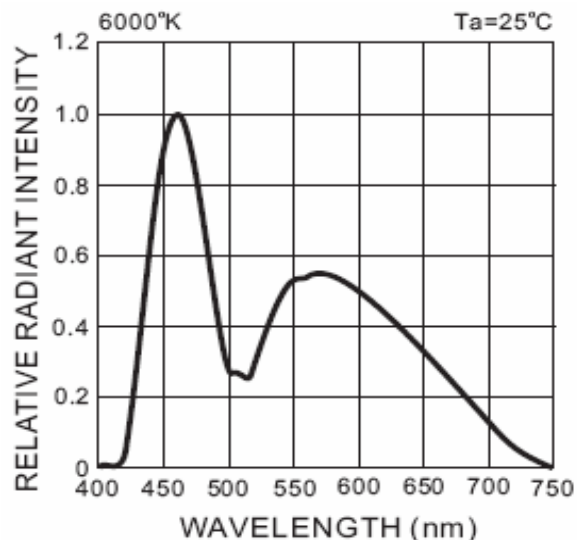
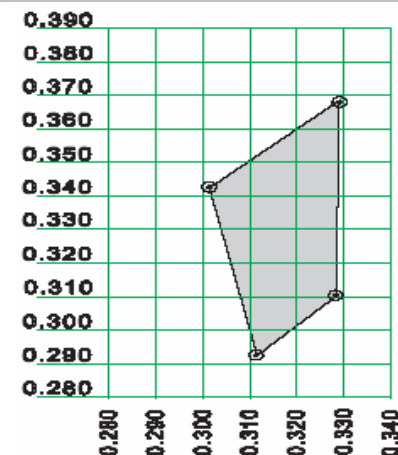

Environmental Test

Test Item	Reference Standard	Test Conditions	Result
Temperature Cycling	MIL-STD-202:107D MIL-STD-750:1051 MIL-STD-833:1010 JIS-C-7021: A4	-.40°C ~ +25°C ~ +85°C ~ +25°C 60min 20min 60min 20min Test Time= 200cycles	0/22
Thermal Shock	MIL-STD-202:107D MIL-STD-750:1051 MIL-STD-833:1010	-.40°C +/- 5°C ~ +110°C +/-5°C 20min 20min. Test Time= 200cycles	0/22

Failure Criteria:

- VF arise $\geq 10\%$
- IV decline $\geq 30\%$
- A failure is an LED that is open or shorted

**50Watt High Power LED
Standard Voltage**

Part No.: **M15018**

DRW:	Jason	CHKD	Wilson	MATL:	Wilson	TOLERANCE	Mason	DATE	05.01.2011	Customer:
APPD:	Schumi			FINISH	Jamy		Sheet No.	6 from 14		

EDCON-COMPONENTS



Typical Electrical Optical Characteristics Curves

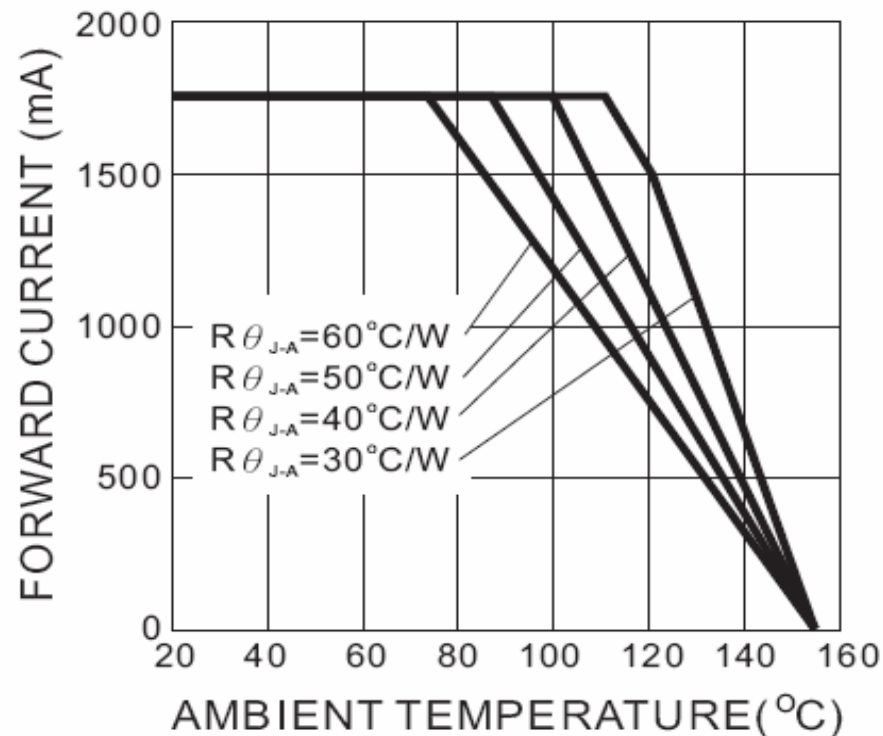
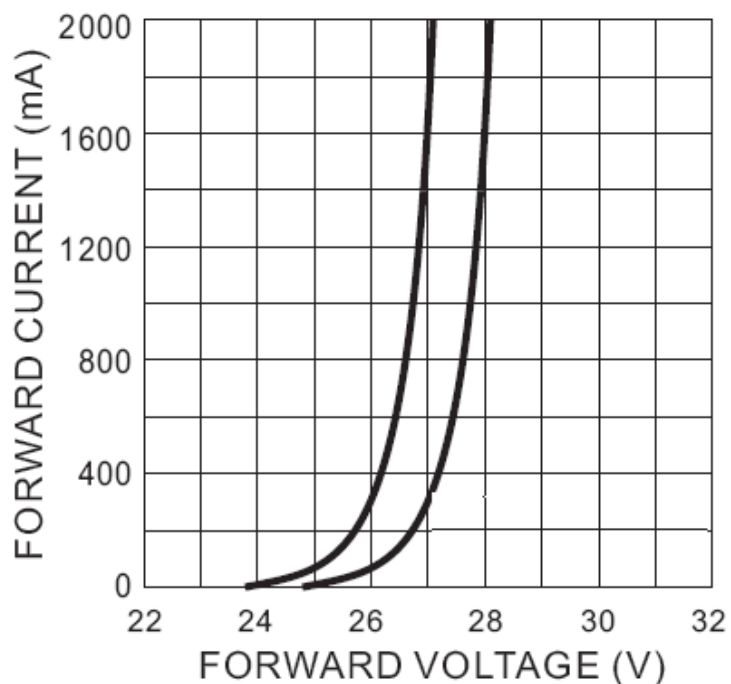

**50Watt High Power LED
Standard Voltage**

Part No.: **M15018**

DRW:	Jason	CHKD	Wilson	MATL:	Wilson	TOLERANCE	Mason	DATE	05.01.2011
APPD:	Schumi			FINISH	Jamy		Sheet No.	7 from 14	

Customer:

EDCON-COMPONENTS



Typical Electrical Optical Characteristics Curves

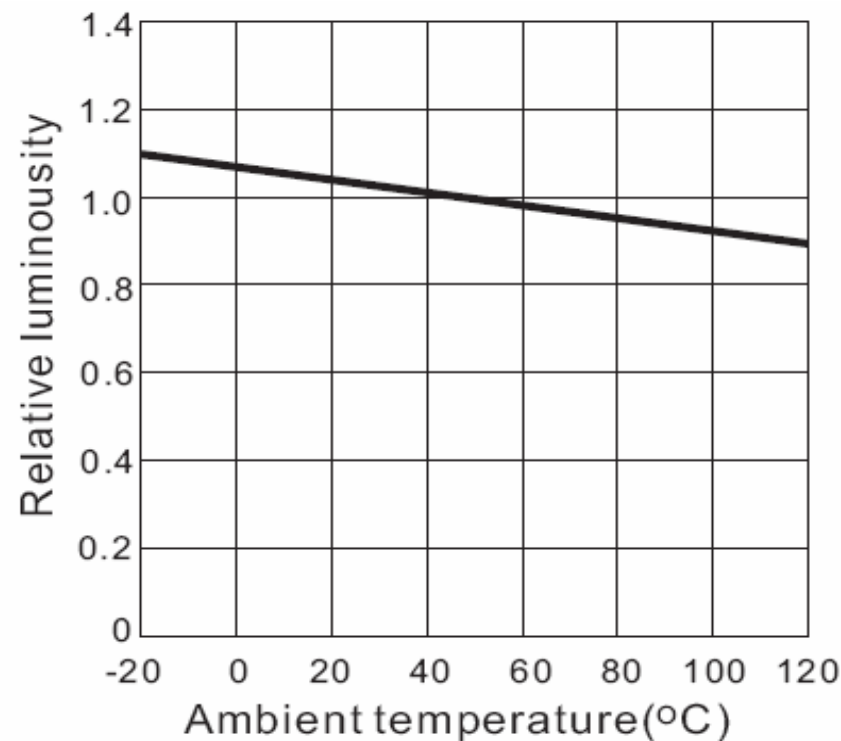
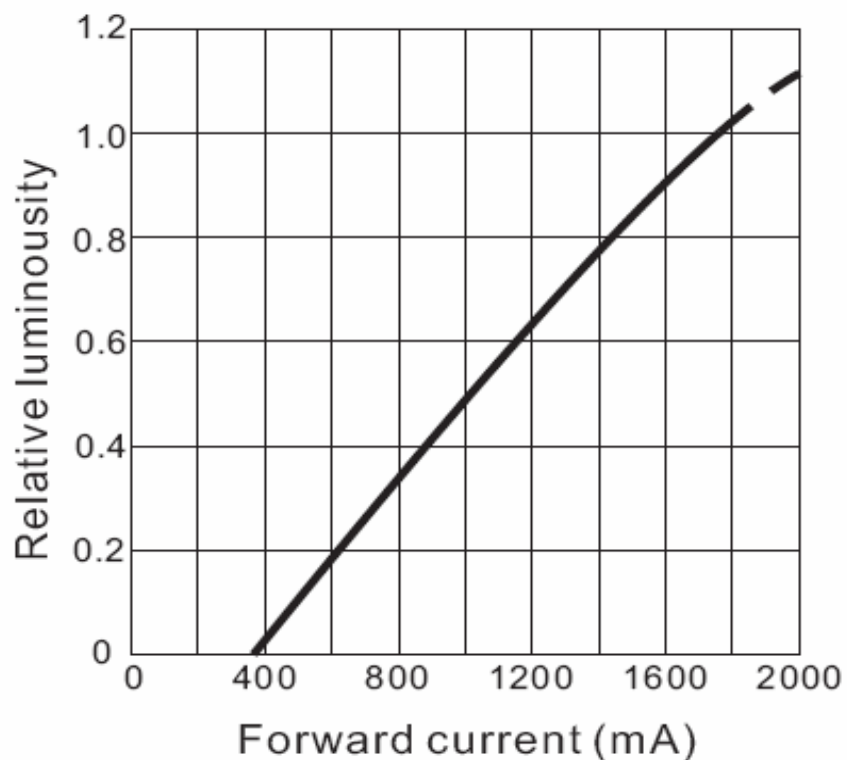

**50Watt High Power LED
Standard Voltage**

Part No.: **M15018**

DRW:	Jason	CHKD	Wilson	MATL:	Wilson	TOLERANCE	Mason	DATE	05.01.2011
APPD:	Schumi			FINISH	Jamy		Sheet No.	8 from 14	Customer:

EDCON-COMPONENTS



Typical Electrical Optical Characteristics Curves

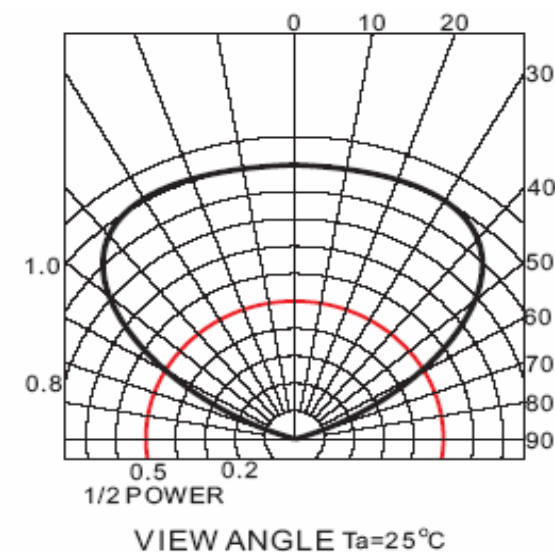
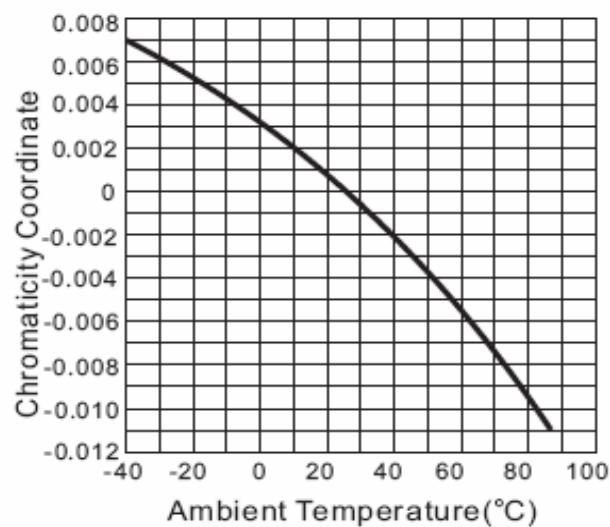
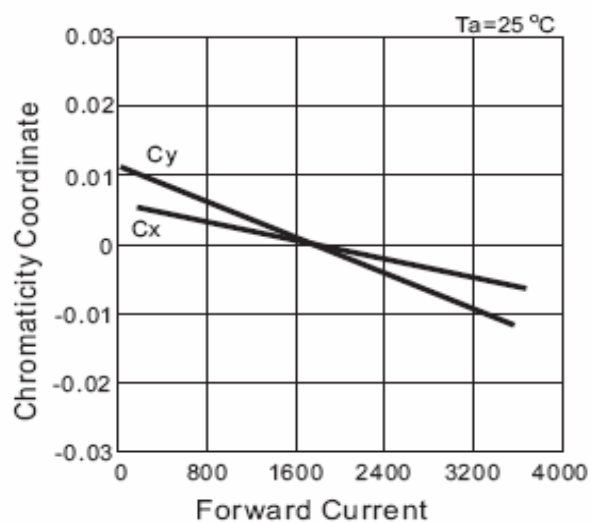

**50Watt High Power LED
Standard Voltage**

Part No.: **M15018**

DRW:	Jason	CHKD	Wilson	MATL:	Wilson	TOLERANCE	Mason	DATE	05.01.2011
APPD:	Schumi			FINISH	Jamy		Sheet No.	9 from 14	Customer:

www.edcon-components.com

email: info@edcon-components.com



Mounting Explanation

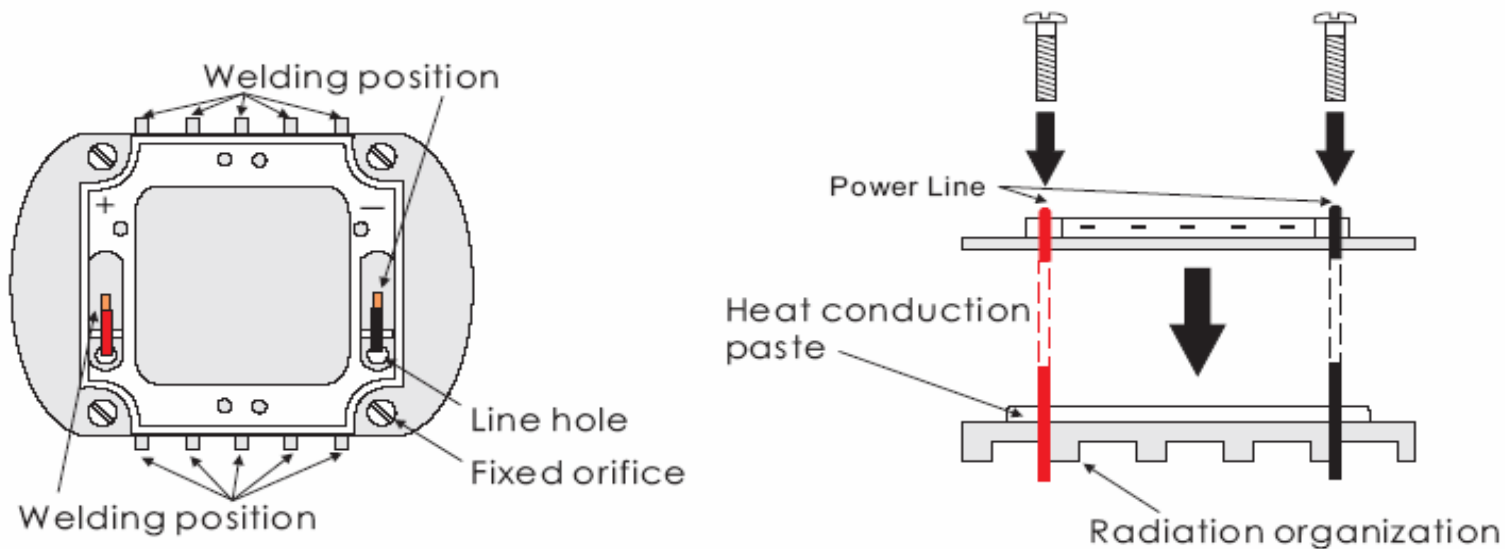

EDCON-COMPONENTS provide simple comparison table for High Power LED, you could find your request heat dissipation area from the following table.

50Watt High Power LED Standard Voltage	
Part No.:	M15018
Customer:	

DRW:	Jason	CHKD	Wilson	MATL:	Wilson	TOLERANCE	Mason	DATE	05.01.2011
APPD:	Schumi			FINISH	Jamy		Sheet No.		10 from 14

EDCON-COMPONENTS



Conclusion

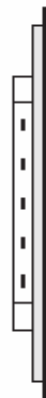

Free Convection Horizontal	
Flat Heat Dissipation Set-up	
(Area Require mm ²)	
White	55,000

Free Convection Vertical	
Flat Heat Dissipation Set-up	
(Area Require mm ²)	
White	41,000

Free Convection	
Finned Heat dissipation Set-up	
(Area Require mm ²)	
White	191,000

TAB in this table is according to highest operating temperature 65°C

Different materials of second heat dissipation device, the surface area of heat sink will be different. Thus, this document is for reference only.

**50Watt High Power LED
Standard Voltage**

Part No.: **M15018**

DRW:	Jason	CHKD	Wilson	MATL:	Wilson	TOLERANCE	Mason	DATE	05.01.2011
APPD:	Schumi			FINISH	Jamy		Sheet No.	11 from 14	Customer:

www.edcon-components.com

email: info@edcon-components.com

EDCON-COMPONENTS



Operating Instructions

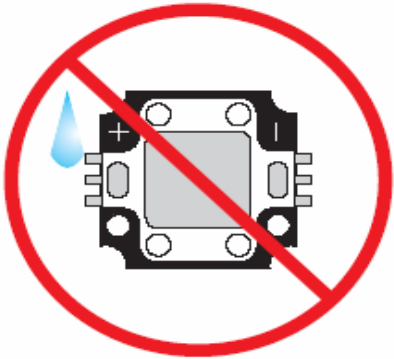

It is important to keep away the product from the water, in order to avoid the product electronic characteristics to be harmful

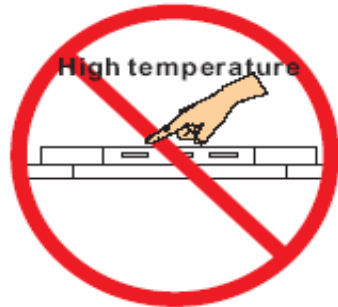

Above 150°C

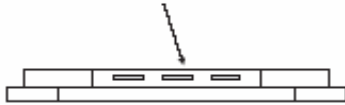

There is 150°C directly from the front of Power LED emitting diode. It is untouchable to prevent burning.



It should be noticed whether there is convection in design of device. Convection has to exist.

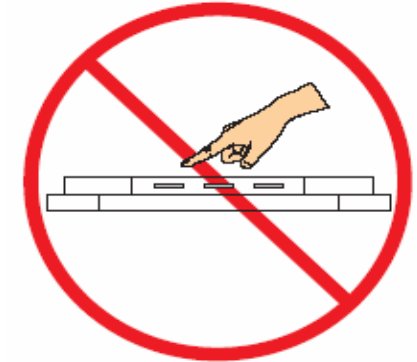

The material in the central top of POWER LED is soft. Therefore, it is un squeezable and untouchable.



Keep Insulation



Power Supply

In the button of heat sink cannot be touched with neither positive nor negative pole. (Heat sink has to be insulation)

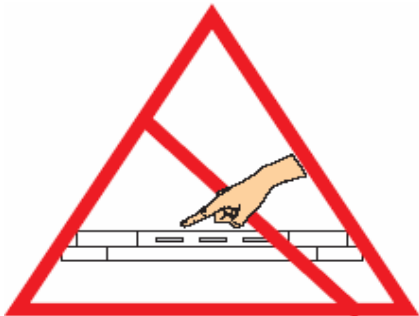

When making use of products, it is necessary to use anti ESD devices to prevent destructive electronic characteristics.

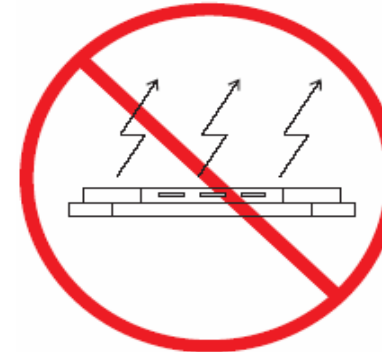

The product should not be light up directly without heat dissipation device

**50Watt High Power LED
Standard Voltage**

Part No.: **M15018**

DRW:	Jason	CHKD	Wilson	MATL:	Wilson	TOLERANCE	Mason	DATE	05.01.2011
APPD:	Schumi			FINISH	Jamy		Sheet No.	12 from 14	Customer:

www.edcon-components.com

email: info@edcon-components.com

EDCON-COMPONENTS



TAB Temperature LIFE Characteristics Curve

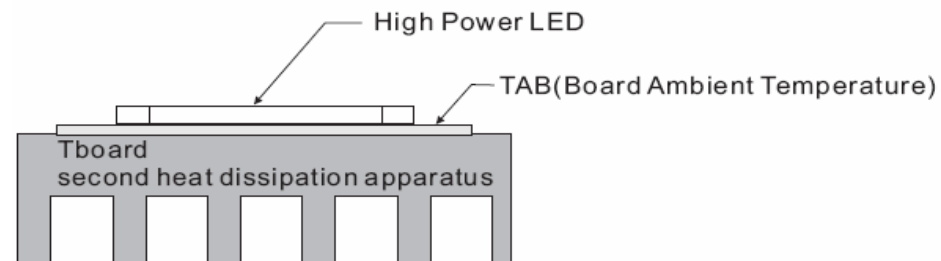
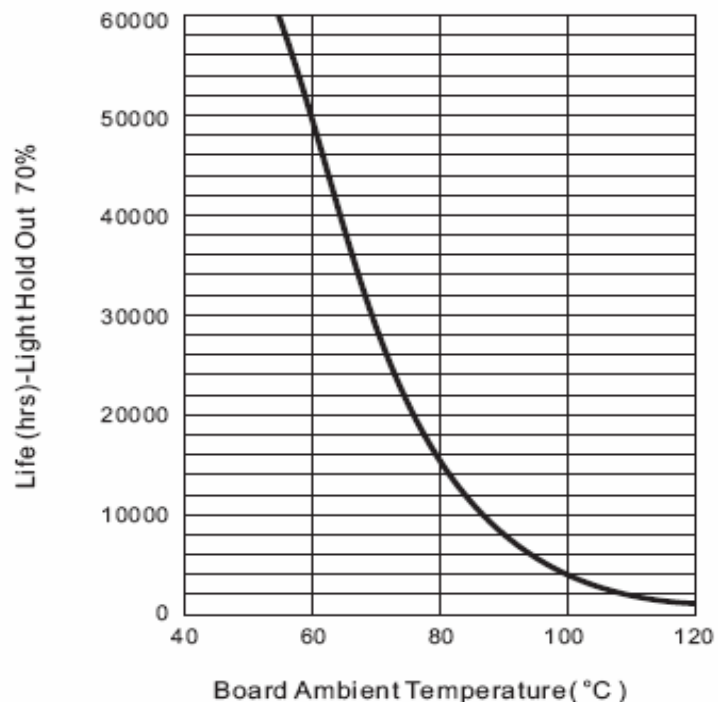

Board Ambient Temperature Tolerance 5°C
 TAB in this table is according to highest operating temperature 65°C
 The TAB is the stable testing value for the product lighted 100% after one hour
 Different materials of second heat dissipation device, the surface area of heat sink will be different,
 Thus, this document is for reference only.

**50Watt High Power LED
 Standard Voltage**

Part No.: **M15018**

DRW:	Jason	CHKD	Wilson	MATL:	Wilson	TOLERANCE	Mason	DATE	05.01.2011
APPD:	Schumi			FINISH	Jamy		Sheet No.	13 from 14	Customer:

EDCON-COMPONENTS



Ordering Informations

Serie	Emitting Color	(Kelvin)	Brightness	ROHS	Packing Code					
-------	----------------	----------	------------	------	--------------	--	--	--	--	--

M15018	PW	6000	3735	R	BU					
---------------	-----------	-------------	-------------	----------	-----------	--	--	--	--	--

PW= Pure White	6000= 6000°K	3735= 3735lm	R= ROHS Conform	BU= Bulk Ware		
			N= NON ROHS Conform	TY= Tray Packing		

**50Watt High Power LED
Standard Voltage**

Part No.: **M15018**

DRW:	Jason	CHKD	Wilson	MATL:	Wilson	TOLERANCE	Mason	DATE	05.01.2011
APPD:	Schumi			FINISH	Jamy		Sheet No.		14 from 14

Customer: