



DATA SHEET

30Watt High Power LED

Serie: M15017

Wavelength **0462= 462nm**

Brightness **0810= 0810lm**

Color: **BL= Blue**

30Watt High Power LED

Serie No.: **M15017**

Customer:

DRW:	Jason	CHKD	Wilson	MATL:	Wilson	TOLERANCE	Mason	DATE	05.01.2011
APPD:	Schumi			FINISH	Jamy		Sheet No.		1 from 14

EDCON-COMPONENTS



Technical Dimensions

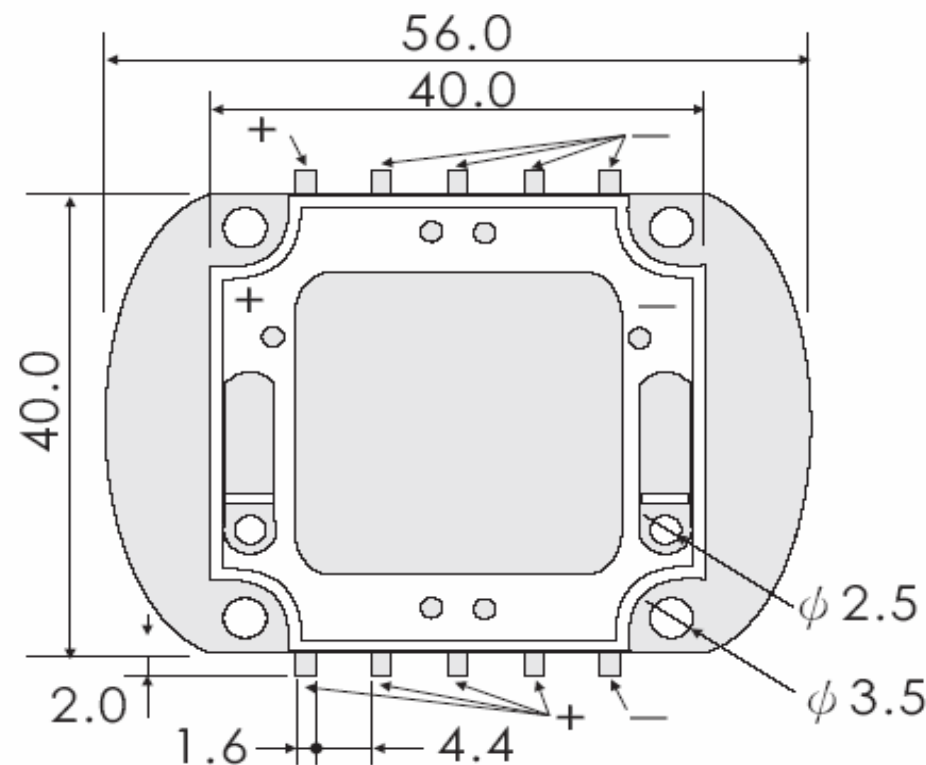
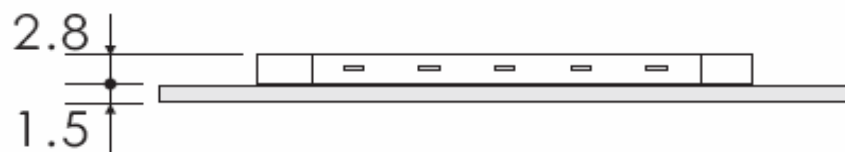

1. All Dimensions are in mm.
2. Lead Spacing in measurement where the lead emerge from the package
3. Protruded resin under flange is 1,5mm max.
4. Tolerance are 0,3mm unless otherwise noted.
5. Specifications are subject to change without notice
6. Driving LED without heat sinking device is forbidden
7. Warps the degree 0,5mm
8. Leds are not designed must to be driven in reverse bias.
9. Proper current derating must be observed to maintain junction temperature below the maximum
10. It is strongly recommended that the temperature of lead be not higher than 55°C.

30Watt High Power LED

Part No.: **M15017**

Customer:

DRW:	Jason	CHKD	Wilson	MATL:	Wilson	TOLERANCE	Mason	DATE	05.01.2011
APPD:	Schumi			FINISH	Jamy		Sheet No.	2 from 14	

EDCON-COMPONENTS



Features

- Long operating life
- Instant Light
- Superior ESD defense
- Low Voltage DC operated
- Color bright saturated
- More energy efficient than incandescent and most halogen lamps

Discription

EDCON-COMPONENTS High Power LED is make of hi-eff AS/TS GaInN chips with precide package technique which makes excellent heat dissipation to reach the advantages of high lunious efficiency, low decay, and long endurance. Now we have these colors available RED, GREEN, BLU, YELLOW, WHITE.

Typical Applications

- Decoration Lights
- Beacon light
- Bathrooms Light
- Medical applications
- Architectural detail lighting

30Watt High Power LED

Part No.: **M15017**

DRW:	Jason	CHKD	Wilson	MATL:	Wilson	TOLERANCE	Mason	DATE	05.01.2011	Customer:
APPD:	Schumi			FINISH	Jamy		Sheet No.	3 from 14		

www.edcon-components.com

email: info@edcon-components.com

EDCON-COMPONENTS



Absolute Maximum Ratings

Parameter	Symbol	Max. Rating	Unit
Continuous Forward Current	IF	1750	mA
Peak Forward Current *1	IFM	2000	mA
Electrostatic Discharge (HBM)	ESD	4000	V
LED Junction Temperature	Tj	G / B	135
		R / Y	125
Operating Temperature	Topr	-40 ~ +110	°C
Storage Temperature	Tstg	-40 ~ +120	°C

Manual Soldering Temperature 260°C for 5seconds max . 2

TA=25°C

*1 Duty Ration = 00,1%, Pulse Width=10us.

*2 Iron soldering high temperature will not cause damage to the dice. But be aware of the high temperature will make the epoxy soften and the gold wire broken and even open. So before returning to the normal temperatures please avoid any serious pressure on the top of epoxy and lead.

*3. We suggest using PWM (Pulse Width Modulation) for driving.

*4 It is recommended to use series as there are several 3pcs. If there are more than 5pcs, please use product with higher power.

Electrical- Optical Characteristics

Parameter	Symbol	Test Cond.	Typ	Unit
View Angel of Half Power	2Ø1/2	1750mA	120	deg
Thermal Resistance Junction to Case	RØ J-C		1,4	°C/W
Temperature Coefficient of Forward Voltage	Δ Vf/Δ T		-2	mV/°C

TA=25°C

Emitting Color	Symbol	Test Cond.	Typ	Max.	Unit
Green	VF	IF=1750mA	17	20	V
Yellow			10,5	13,5	
Red			10,5	13,5	
Blue			17	20	
Blue			17	20	

TA=25°C

30Watt High Power LED

Part No.: **M15017**

DRW:	Jason	CHKD	Wilson	MATL:	Wilson	TOLERANCE	Mason	DATE	05.01.2011	Customer:
APPD:	Schumi			FINISH	Jamy		Sheet No.	4 from 14		

EDCON-COMPONENTS



Electrical Optical Characteristics for Luminous Intensity

Emitting Color	Symbol	Test Cond.	Typ	Unit
Green	VF	IF=1750mA	2150	V
Yellow			1640	
Red			1690	
Blue			810	
Blue			910	
Tolerance: 15% of EDCON- measuring equipments: EXELTRON 2001.2.S370 made by U.D.T:				

TA=25°C

Electrical-Optical Characteristics for Wavelength

Emitting Color	Test Cond.	P	d	Unit
Green	IF=1750mA	520	525	nm
Yellow		595	590	
Red		635	625	
Blue		462	465	
Blue		462	465	
Tolerance: 15% of EDCON- measuring equipments: EXELTRON 2001.2.S370 made by U.D.T:				

TA=25°C

Endurance Test

Test Item	Reference Standard	Test Conditions	Result
Operating Life	MIL-STD-750:1026 MIL-STD-883:1005 JIS-C-7021: B-1	Connect with a power if=700mA Ta=Under room temperature Trest Time = 1000hrs	0/22
High Temperature High Humidity Storage	MIL-STD-202:103B JIS-C-7021: B-11	Ta= +85°C +/-5°C RH=80% ~ 85% Test Time = 1000hrs	0/22
High Temperature Storage	MIL-STD-883:1008 JIS-C-7021: B-10	High Ta= +120°C +/- 5°C Test Time= 1000hrs	0/22
Low Temperature Storage	JIS-C-7021: B-12	Low Ta= 40°C +/-5°C Test Time= 1000hrs	0/22

Failure Criteria:

- VF arise $\geq 10\%$
- IV decline $\geq 30\%$
- A failure is an LED that is open or shorted

30Watt High Power LED

Part No.: **M15017**

DRW:	Jason	CHKD	Wilson	MATL:	Wilson	TOLERANCE	Mason	DATE	05.01.2011	Customer:
APPD:	Schumi			FINISH	Jamy		Sheet No.	5 from 14		

www.edcon-components.com

email: info@edcon-components.com

EDCON-COMPONENTS



Environmental Test

Test Item	Reference Standard	Test Conditions	Result
Temperature Cycling	MIL-STD-202:107D MIL-STD-750:1051 MIL-STD-833:1010 JIS-C-7021: A4	. -40°C ~ +25°C ~ +85°C ~ +25°C 60min 20min 60min 20min Test Time= 200cycles	0/22
Thermal Shock	MIL-STD-202:107D MIL-STD-750:1051 MIL-STD-833:1010	. -40°C +/- 5°C ~ +110°C +/-5°C 20min 20min. Test Time= 200cycles	0/22

Failure Criteria:

1. VF arise $\geq 10\%$
2. IV decline $\geq 30\%$
3. A failure is an LED that is open or shorted

30Watt High Power LED

Part No.: **M15017**

DRW:	Jason	CHKD	Wilson	MATL:	Wilson	TOLERANCE	Mason	DATE	05.01.2011	Customer:
APPD:	Schumi			FINISH	Jamy		Sheet No.	6 from 14		



Typical Electrical Optical Characteristics Curves

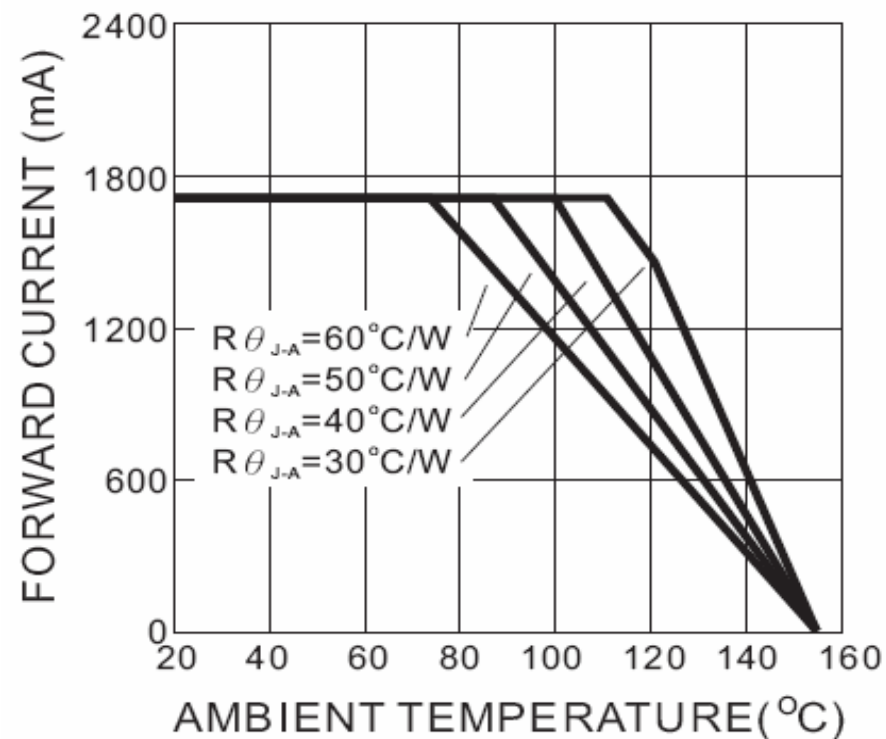
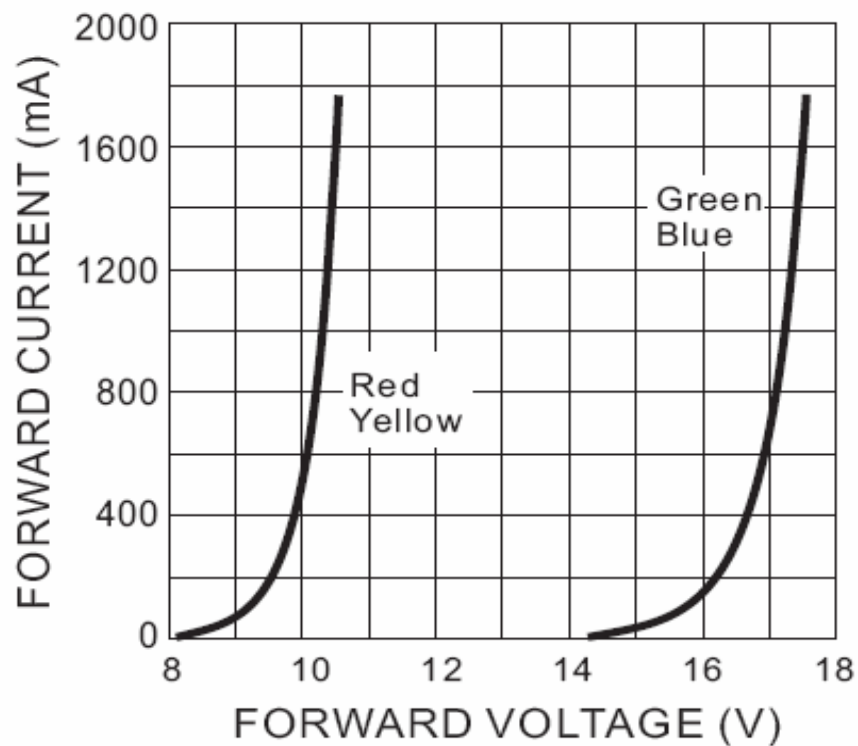

30Watt High Power LED

Part No.: **M15017**

DRW:	Jason	CHKD	Wilson	MATL:	Wilson	TOLERANCE	Mason	DATE	05.01.2011
APPD:	Schumi			FINISH	Jamy		Sheet No.	7 from 14	Customer:

EDCON-COMPONENTS



Typical Electrical Optical Characteristics Curves

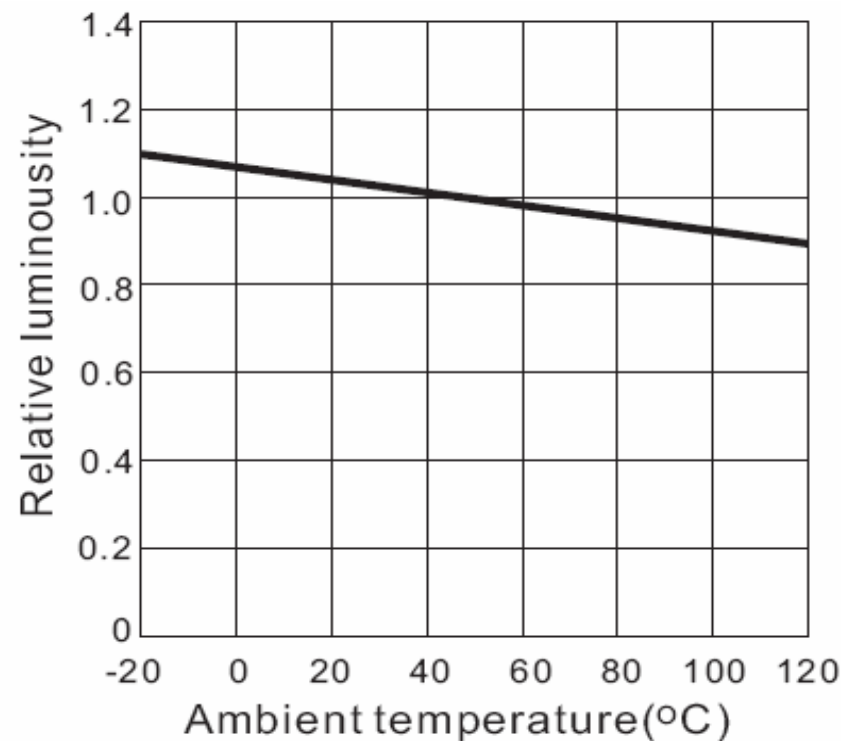
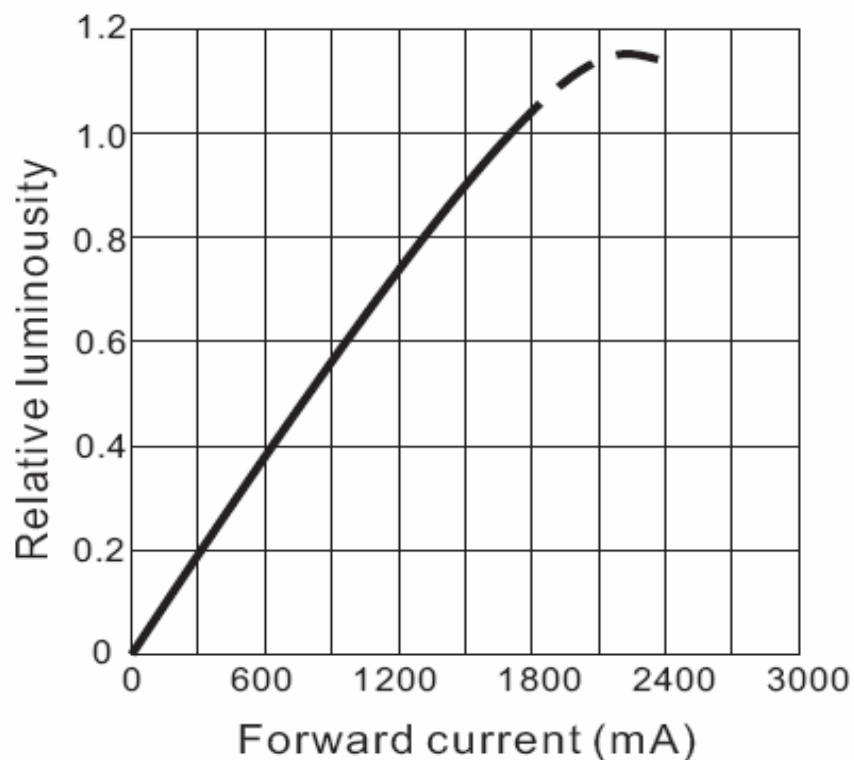

30Watt High Power LED

Part No.: **M15017**

DRW:	Jason	CHKD	Wilson	MATL:	Wilson	TOLERANCE	Mason	DATE	05.01.2011
APPD:	Schumi			FINISH	Jamy		Sheet No.	8 from 14	Customer:

www.edcon-components.com

email: info@edcon-components.com

EDCON-COMPONENTS



Typical Electrical Optical Characteristics Curves

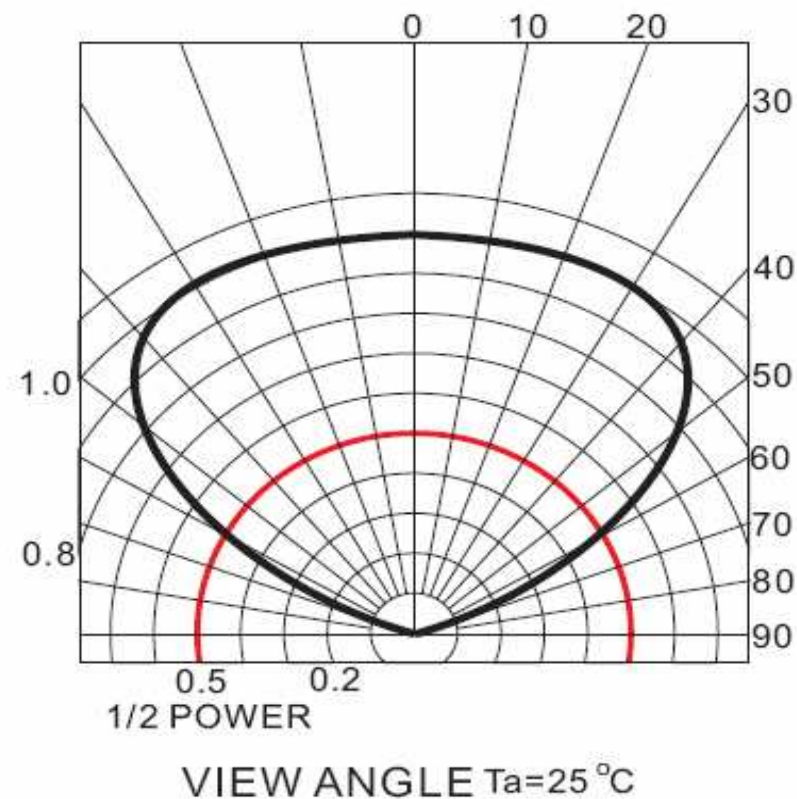
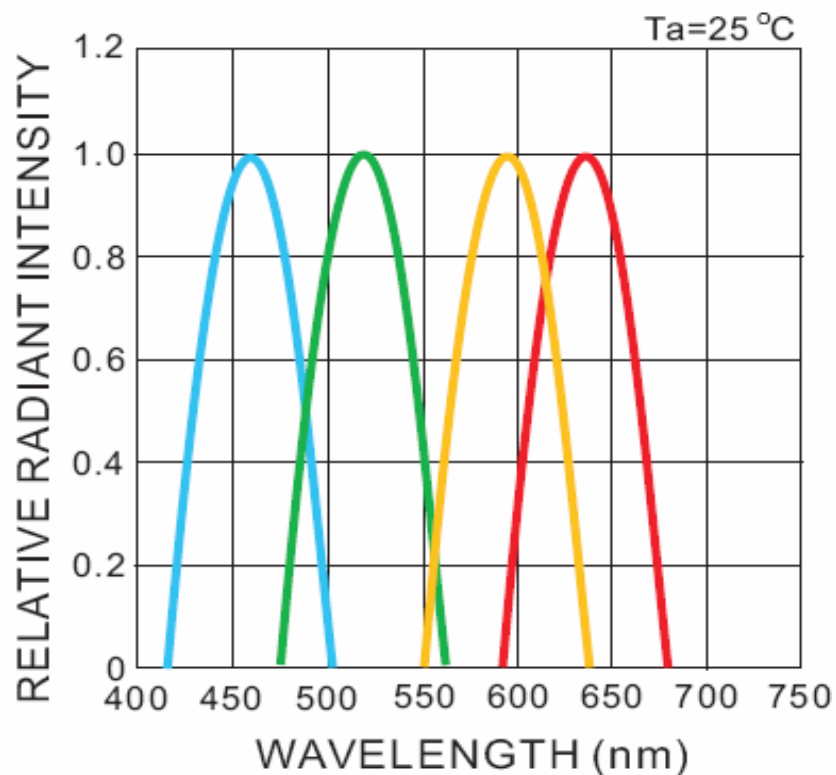

30Watt High Power LED

Part No.: **M15017**

DRW:	Jason	CHKD	Wilson	MATL:	Wilson	TOLERANCE	Mason	DATE	05.01.2011	Customer:
APPD:	Schumi			FINISH	Jamy		Sheet No.	9 from 14		



Mounting Explanation

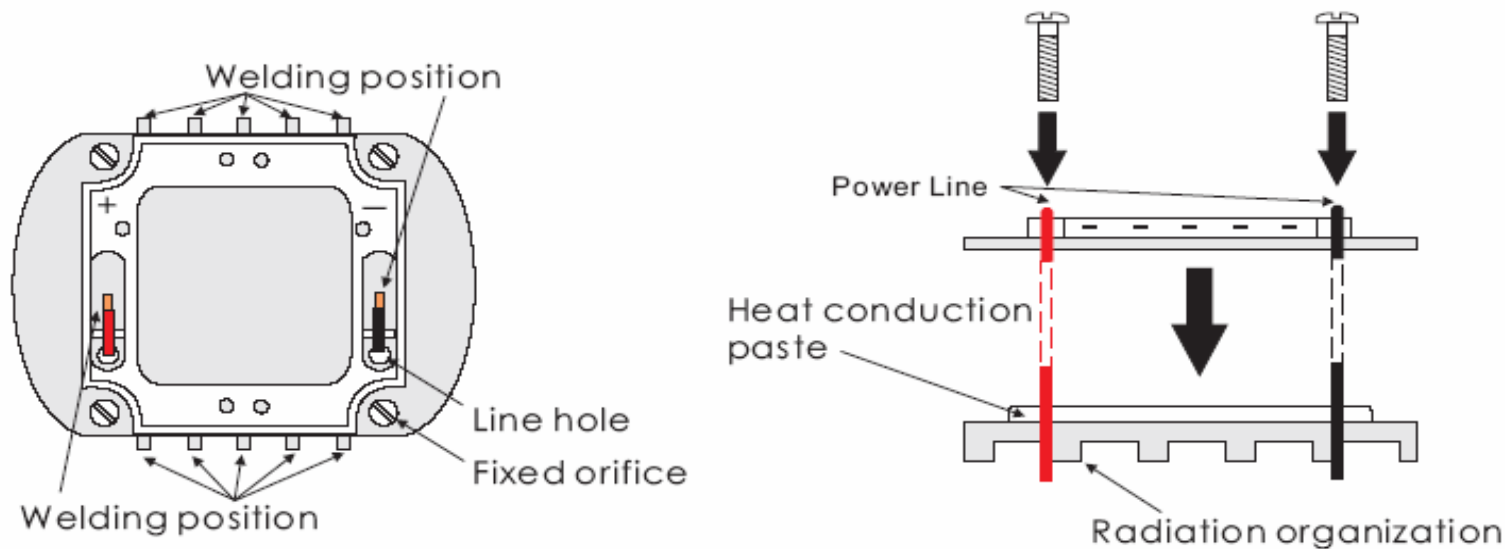

EDCON-COMPONENTS provide simple comparison table for High Power LED, you could find your request heat dissipation area from the following table.

30Watt High Power LED	
Part No.:	M15017
Customer:	

DRW:	Jason	CHKD	Wilson	MATL:	Wilson	TOLERANCE	Mason	DATE	05.01.2011
APPD:	Schumi			FINISH	Jamy		Sheet No.	10 from 14	

EDCON-COMPONENTS



Conclusion

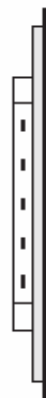

Free Convection Horizontal Flat Heat Dissipation Set-up (Area Require mm ²)	
Green	43,500
Yellow	22,500
Red	14,500
Blue	33,000

Free Convection Vertical Flat Heat Dissipation Set-up (Area Require mm ²)	
Green	32,500
Yellow	17,000
Red	10,500
Blue	25,000

Free Convection Finned Heat dissipation Set-up (Area Require mm ²)	
Green	151,500
Yellow	78,000
Red	49,000
Blue	115,000

TAB in this table is according to highest operating temperature 65°C

Different materials of second heat dissipation device, the surface area of heat sink will be different. Thus, this document is for reference only.

30Watt High Power LED	
Part No.:	M15017
Customer:	

DRW:	Jason	CHKD	Wilson	MATL:	Wilson	TOLERANCE	Mason	DATE	05.01.2011
APPD:	Schumi			FINISH	Jamy		Sheet No.	11 from 14	

EDCON-COMPONENTS



Operating Instructions

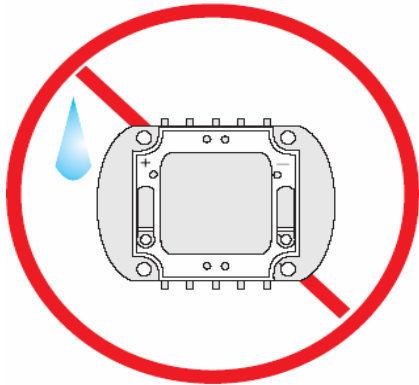

It is important to keep away the product from the water, in order to avoid the product electronic characteristics to be harmful

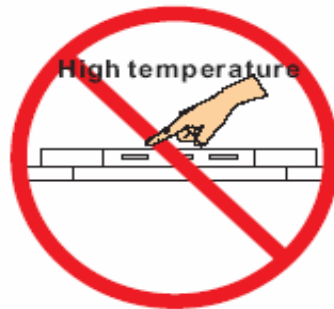

Above 150°C

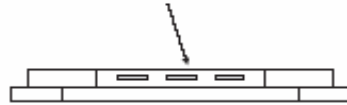

There is 150°C directly from the front of Power LED emitting diode. It is untouchable to prevent burning.

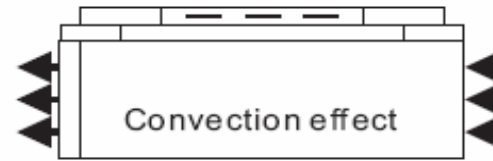

It should be noticed whether there is convection in design of device. Convection has to exist.

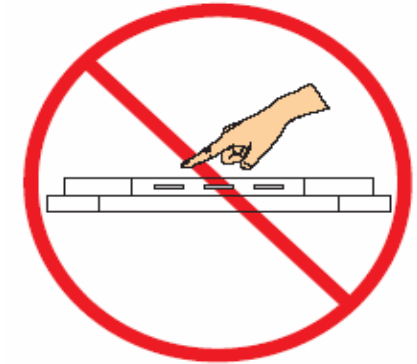

The material in the central top of POWER LED is soft. Therefore, it is un squeezable and untouchable.



Keep Insulation



Power Supply

In the button of heat sink cannot be touched with neither positive nor negative pole. (Heat sink has to be insulation)

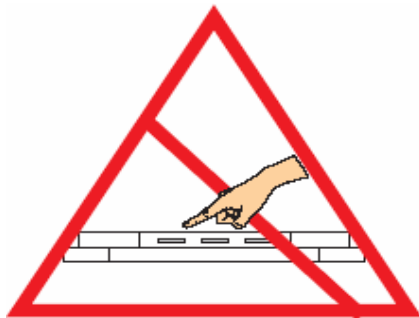

When making use of products, it is necessary to use anti ESD devices to prevent destructive electronic characteristics.

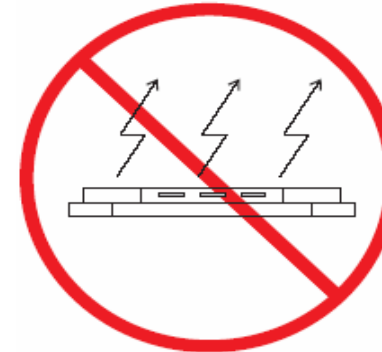

The product should not be light up directly without heat dissipation device

30Watt High Power LED

Part No.: **M15017**

DRW:	Jason	CHKD	Wilson	MATL:	Wilson	TOLERANCE	Mason	DATE	05.01.2011	Customer:
APPD:	Schumi			FINISH	Jamy		Sheet No.	12 from 14		

EDCON-COMPONENTS



TAB Temperature LIFE Characteristics Curve

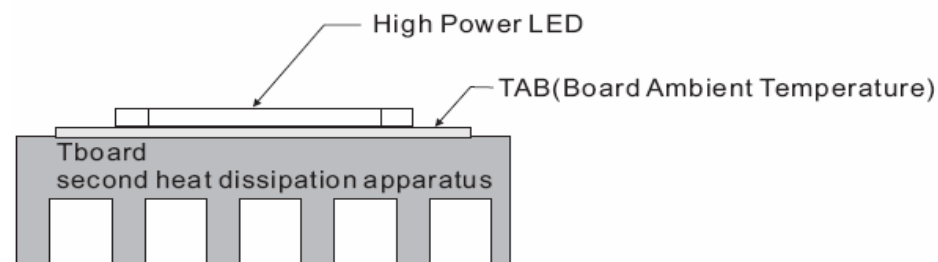
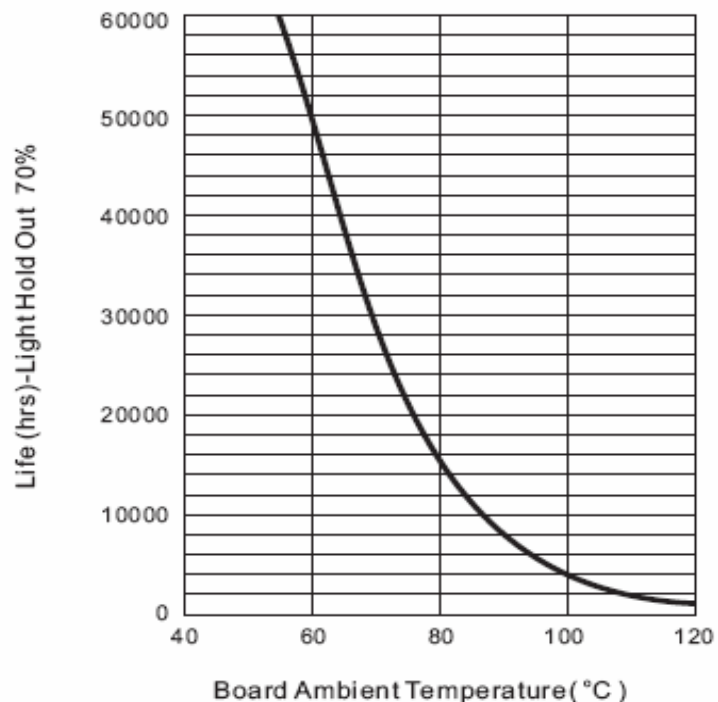

Board Ambient Temperature Tolerance 5°C
 TAB in this table is according to highest operating temperature 65°C
 The TAB is the stable testing value for the product lighted 100% after one hour
 Different materials of second heat dissipation device, the surface area of heat sink will be different,
 Thus, this document is for reference only.

30Watt High Power LED

Part No.: **M15017**

DRW:	Jason	CHKD	Wilson	MATL:	Wilson	TOLERANCE	Mason	DATE	05.01.2011	Customer:
APPD:	Schumi			FINISH	Jamy		Sheet No.	13 from 14		

EDCON-COMPONENTS



Ordering Informations

Serie	Emitting Color	Wavelength (nm) or (°K)	Brightness	ROHS	Packing Code					
-------	----------------	-------------------------	------------	------	--------------	--	--	--	--	--

M15017	BL	0462	0810	R	BU					
---------------	-----------	-------------	-------------	----------	-----------	--	--	--	--	--

BL= Blue	0462= 462nm	0810= 0810lm	R= ROHS Conform	BU= Bulk Ware		
			N= NON ROHS Conform	TY= Tray Packing		

30Watt High Power LED

Part No.: **M15017**

DRW:	Jason	CHKD	Wilson	MATL:	Wilson	TOLERANCE	Mason	DATE	05.01.2011
APPD:	Schumi			FINISH	Jamy		Sheet No.		14 from 14

Customer: