

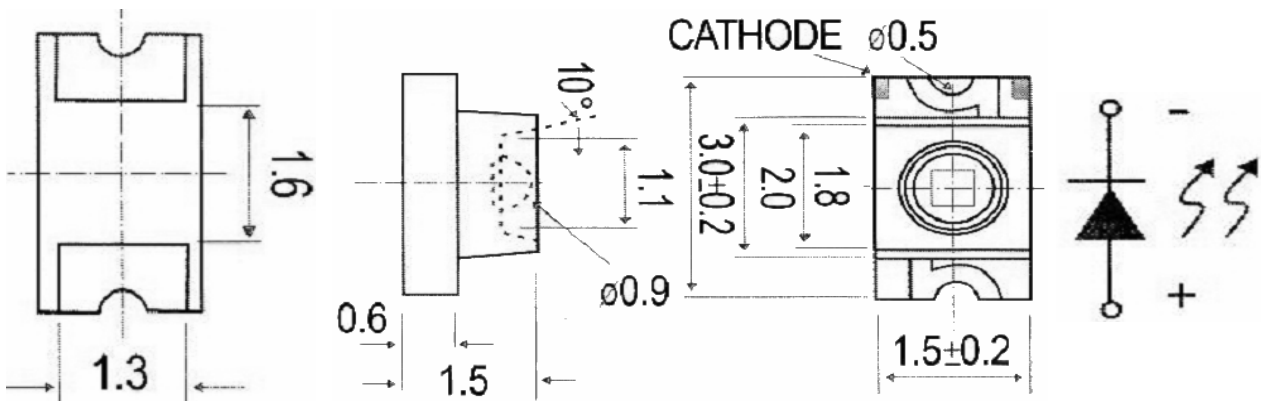

**Applications**

- Interior automotive lighting
- Optical indicators
- Communication Products
- Backlighting
- Toys

**Technical Drawing**



**Recommended Soldering Pattern**

**Notes :**

All dimensions in mm tolerance is  $\pm 0.1\text{mm}$  unless otherwise noted.

<b>Inner Lens Chip LED</b> <b>Red</b>	
Part No.:	<b>M11G6005</b>
Customer:	

DRW:	Dong	CHKD	Chang	MATL:	Chui	DATE	04.12.2009
APPD:	Ping			FINISH	Hui	Sheet	1 from 9



**Absolute Maximum Ratings**

Ta=25°C

Item	Symbol	AlGaInP	Unit
Power Dissipation	P <sub>D</sub>	---	mW
DC Forward Current	I <sub>F</sub>	20	mA
Pulsed Forward Current	I <sub>FP</sub> *	---	mA
Reverse Voltage	V <sub>R</sub>	---	V
Operating Temperature	T <sub>OP</sub>	---	°C
Storage Temperature	T <sub>ST</sub>	-55 to 100	°C

\* 0.1 msec pulse, 10% duty cycle

**Electrical / Optical Characteristics**

I<sub>F</sub>=20mA Ta=25°C

Ermitting Color	Red		
Material	AlGaInP		
Forward Voltage	typ.	2.0	V <sub>F</sub>
	max.	2.4	V <sub>F</sub>
Wavelength typ.	λ <sub>D</sub>	624	nm
	λ <sub>P</sub>	---	nm
	Δλ	---	nm
Color Temperature	min.	---	K
	max.	---	K
Luminous Intensity *	min.	19	mcd
	typ.	47	mcd
Reverse Current	max.	---	μA
Viewing Angle	2Θ1/2	120	

\* Per NIST standards

**Inner Lens Chip LED**  
**Red**

Part No.: **M11G6005**

Customer:

DRW:	Dong	CHKD	Chang	MATL:	Chui	DATE	04.12.2009
APPD:	Ping			FINISH	Hui	Sheet	2 from 9



**Curve**

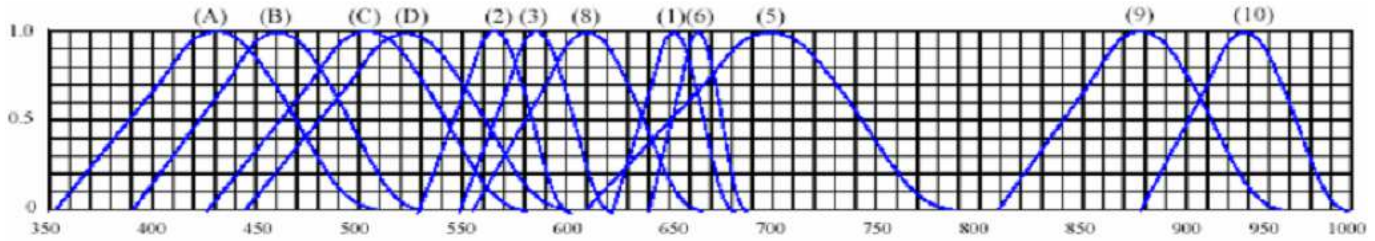

Wavelength ( nm )

**Relative Intensity vs Wavelength**

( 1 )	GaAsP / GaAs 655nm Red	( 9 )	GaAlAs 880nm
( 2 )	GaP 568nm Yellow Green	( 10 )	GaAs & GaAlAs 940nm
( 3 )	GaAsP / GaP 585nm Yellow	( A )	GaN 430nm Blue
( 4 )	GaAsP / GaP 635nm Orange & Red	( B )	InGaN 470nm Blue
( 5 )	GaP 700nm Red	( C )	InGaN 502nm Green
( 6 )	GaAlAs / GaAs 660nm Red	( D )	InGaN 523nm Green
( 8 )	GaAsP / GaP 610nm Red		

**Inner Lens Chip LED  
 Red**

Part No.: **M11G6005**

Customer:

DRW:	Dong	CHKD	Chang	MATL:	Chui	DATE	04.12.2009
APPD:	Ping			FINISH	Hui	Sheet	3 from 9

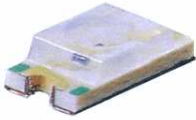

**Curve**

FORWARD CURRENT VS. FORWARD VOLTAGE

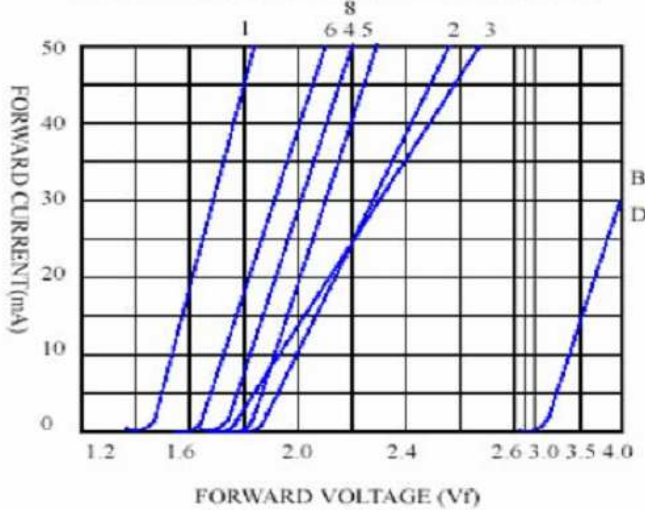

RELATIVE LUMINOUS INTENSITY VS. FORWARD CURRENT

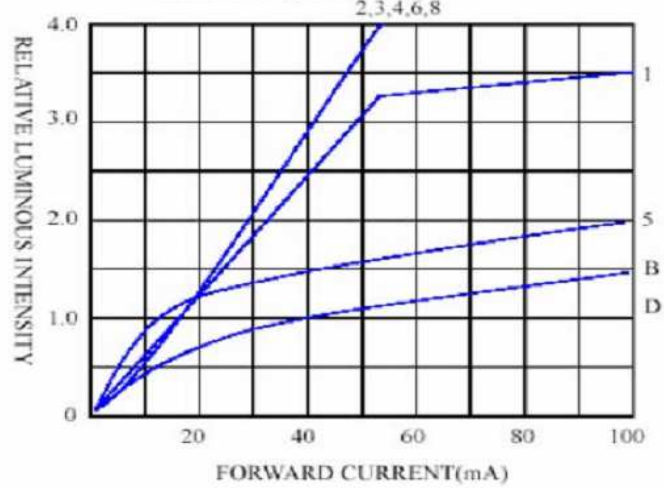

FORWARD CURRENT VS. AMBIENT TEMPERATURE

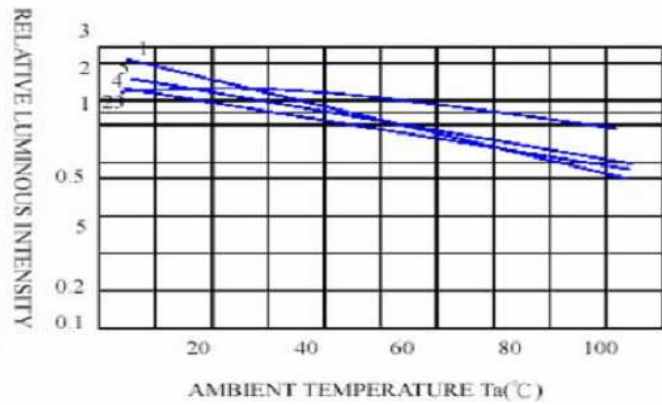
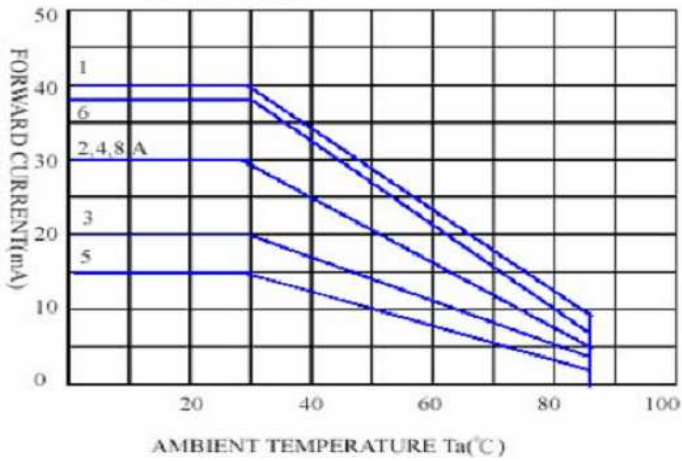

**Inner Lens Chip LED  
Red**

Part No.: **M11G6005**

Customer:

DRW:	Dong	CHKD	Chang	MATL:	Chui	DATE	04.12.2009
APPD:	Ping			FINISH	Hui	Sheet	4 from 9



**Solder Condition**

**Lead Free Solder**

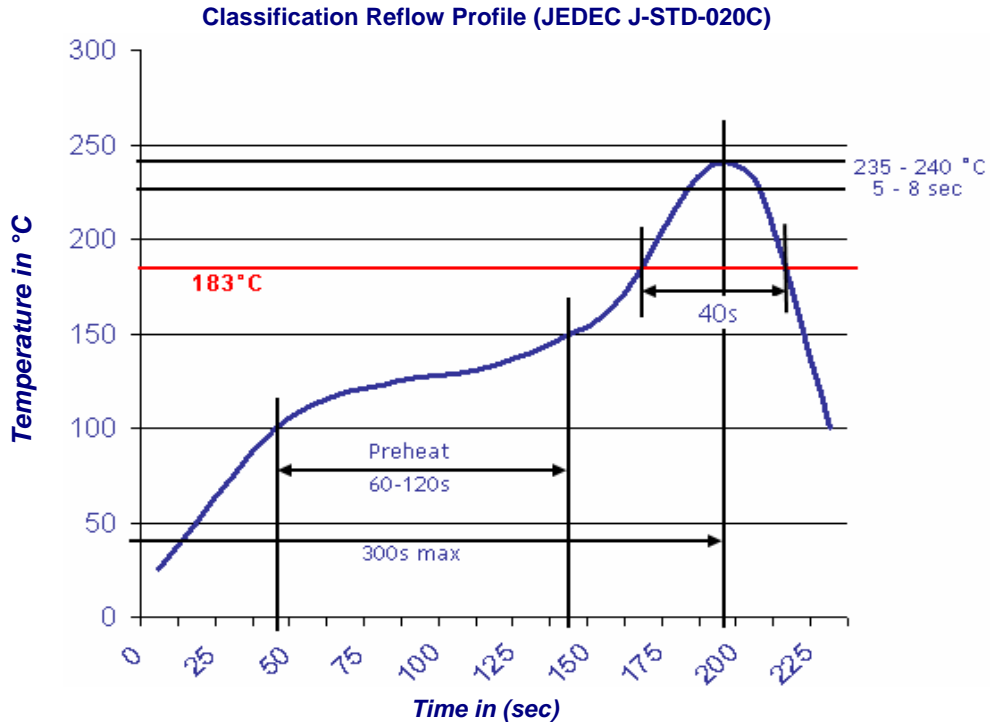

<b>Inner Lens Chip LED Red</b>	
Part No.:	<b>M11G6005</b>
Customer:	

DRW:	Dong	CHKD	Chang	MATL:	Chui	DATE	04.12.2009
APPD:	Ping			FINISH	Hui	Sheet	5 from 9



**Packing Specifications**

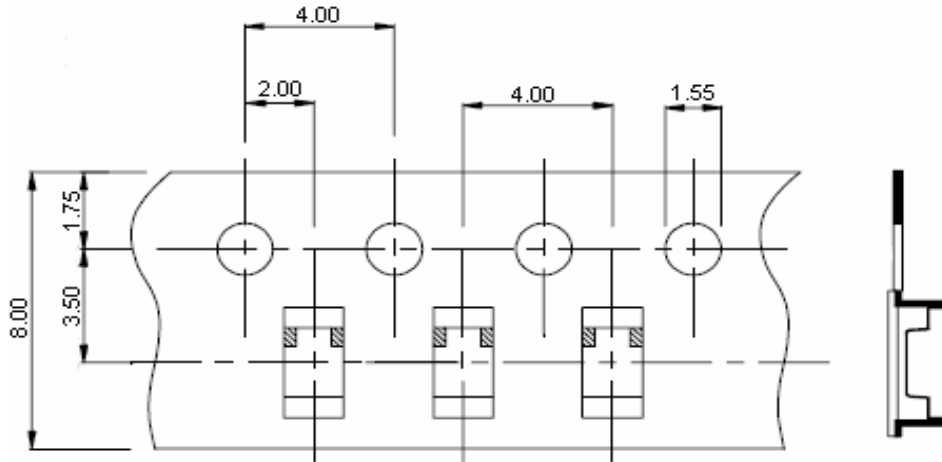

**Reel Specifications**

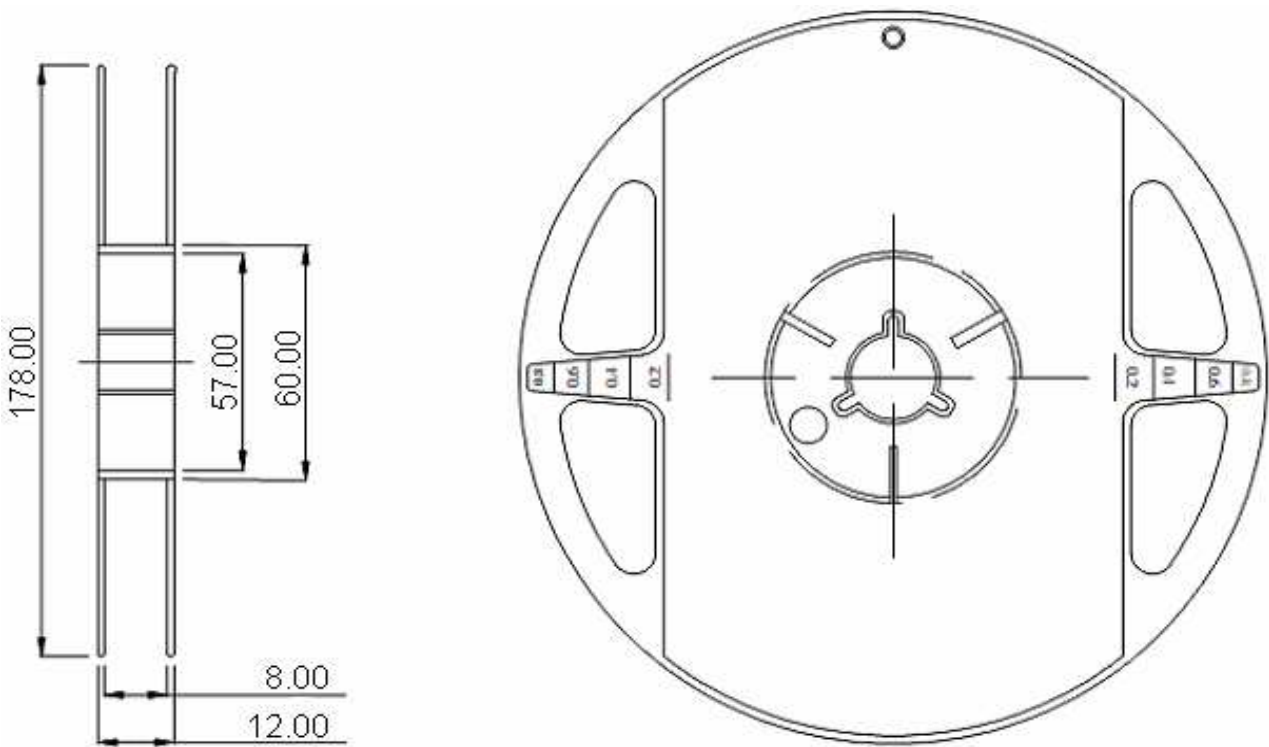

**Inner Lens Chip LED  
 Red**

Part No.: **M11G6005**

Customer:

DRW:	Dong	CHKD	Chang	MATL:	Chui	DATE	04.12.2009
APPD:	Ping			FINISH	Hui	Sheet	6 from 9





**Handling Precautions**

Compare to epoxy encapsulant that is hard and brittle, silicone is softer and flexible. Although its characteristic significantly reduces thermal stress, it is more susceptible to damage by external mechanical force. As a result, special handling precautions need to be observed during assembly using silicone encapsulated LED products. Failure to comply might lead to damage and premature failure of the LED.

1. Handle the component along the side surfaces by using forceps or appropriate tools

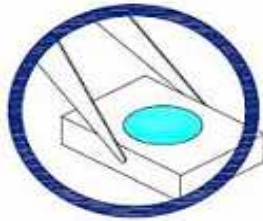

2. Do not directly touch or handle the silicone lens surface. It may damage the internal circuitry.

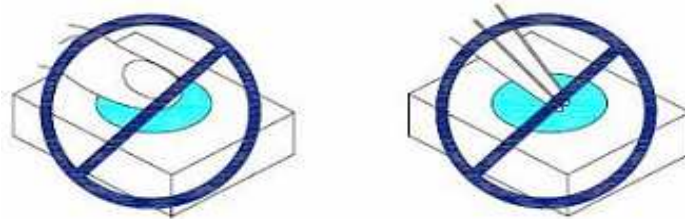

3. Do not stack together assembled PCBs containing exposed LEDs. Outside impact may scratch the silicone lens or damage the internal circuitry.



<b>Inner Lens Chip LED</b>	
<b>Red</b>	
Part No.:	<b>M11G6005</b>
Customer:	

DRW:	Dong	CHKD	Chang	MATL:	Chui	DATE	04.12.2009
APPD:	Ping			FINISH	Hui	Sheet	7 from 9



4. The outer diameter of the TOP LED pickup nozzle should not exceed the size of the LED to prevent air leaks. The inner diameter of the nozzle should be as large as possible.
5. A pliable material is suggested for the nozzle tip to avoid scratching or damaging the LED surface during pickup.
6. The dimensions of the component must be accurately programmed in the pick-and-place machine to insure precise pickup and avoid damage during production.

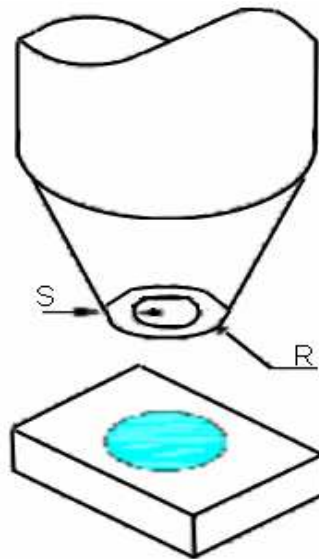

<b>Inner Lens Chip LED Red</b>	
Part No.:	<b>M11G6005</b>
Customer:	

DRW:	Dong	CHKD	Chang	MATL:	Chui	DATE	04.12.2009
APPD:	Ping			FINISH	Hui	Sheet	8 from 9





**Color table curve**

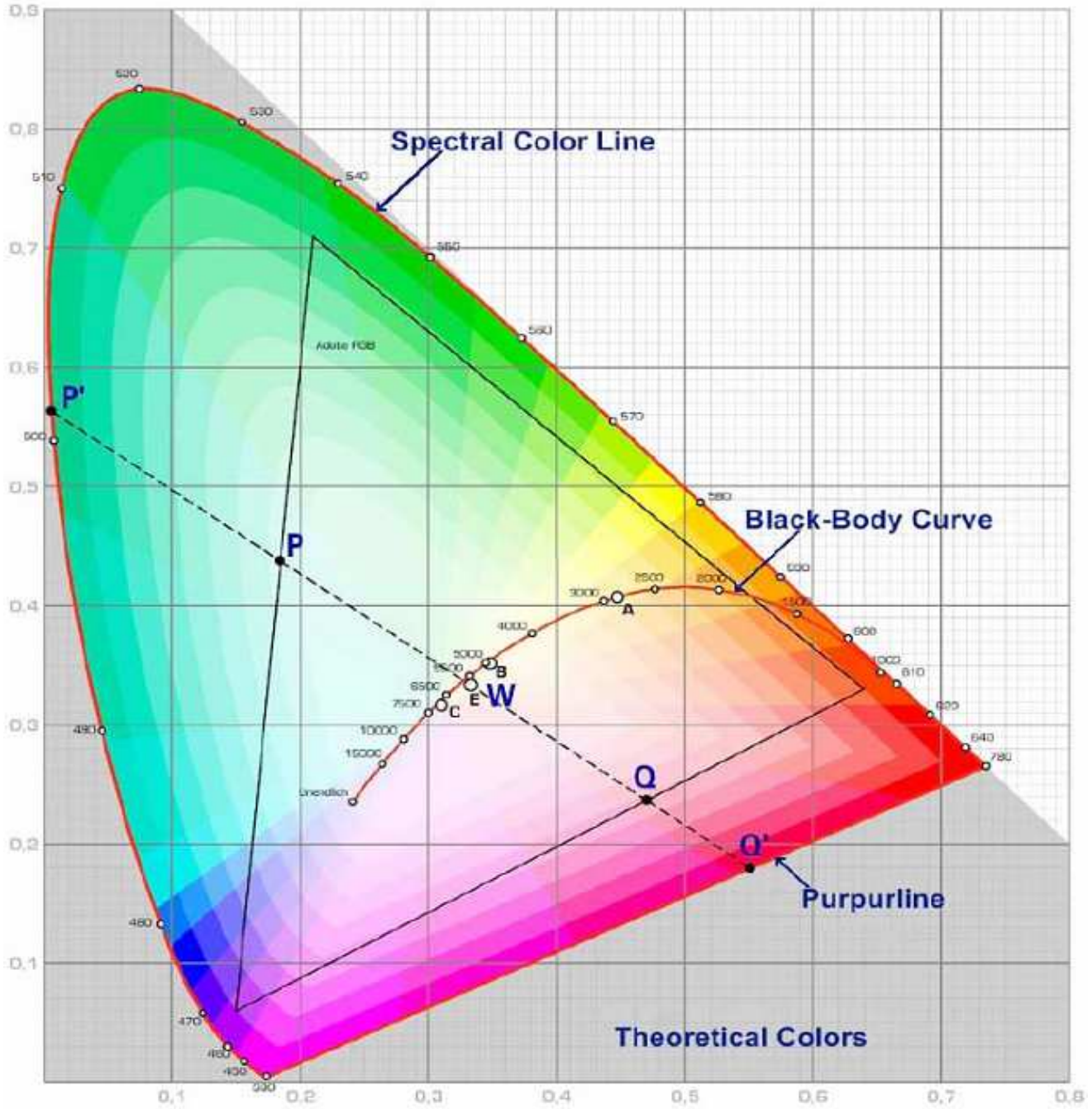

<b>Inner Lens Chip LED Red</b>	
Part No.:	<b>M11G6005</b>
Customer:	

DRW:	Dong	CHKD	Chang	MATL:	Chui	DATE	04.12.2009
APPD:	Ping			FINISH	Hui	Sheet	9 from 9

Copyright by EDCON-COMPONENTS