

EDCON-COMPONENTS



Technical Parameter:

Color of Laser: Red
 Supply Voltage: 3V
 Wavelength: 635nm
 Output Power: 5mW

Application: Laser Liner
 Wire Lead length: 100mm
 Color of Wire: Red / Black
 Open end 5mm tinned ends

This Product complies with 21 CFR 1040.10 and 1040.11

This beam emitted from the laser module is visible and may be harmful to the human eye. Avoid any possibility of looking into the laser package or the collimated beam along its optical axis when the device is in operation

ESD precautions must be taken when handling unit.

Visible laser radiation avoid direct exposure to beam.

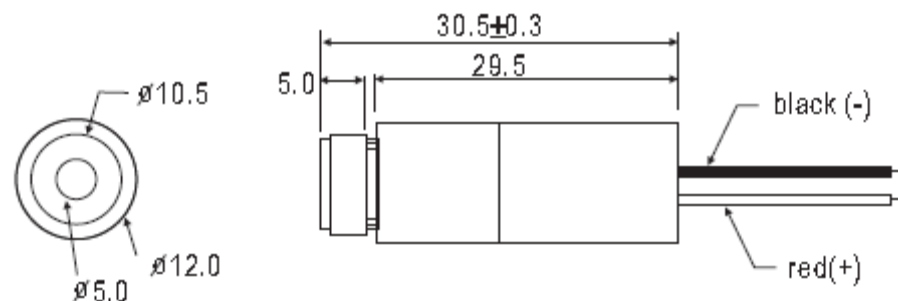

Laser Products

Part No.: **M29011**

Customer:

DRW:	Jason	CHKD	Wilson	MATL:	Wilson	TOLERANCE	Mason	DATE	01.08.2010
APPD:	Schumi			FINISH	Jamy		Sheet No.	1 from 1	

EDCON-COMPONENTS



Ordering Information

Serie	Wavelength	Voltage	Output Power	Wire Lead Length	ROHS	Packing				
M29011	635	3V	005	151	R	B				

635= 635nm	3V= 3 Volt	005= 5mW	151= 150mm (Standard)	R= ROHS Conform	B= One PCS in Antistatic Polybag

Laser Products
Part No.: M29011
Customer:

DRW:	Jason	CHKD	Wilson	MATL:	Wilson	TOLERANCE	Mason	DATE	01.08.2010
APPD:	Schumi			FINISH	Jamy		Sheet No.	2 from 2	