

EDCON-COMPONENTS



Specifications

Voltage Rating: 30 VAC
 Current Rating: 1,0A
 Operating Temperature: -55°C to + 85°C
 Contact Resistance: 50m Ohm max.
 Withstanding Voltage: 100VAC min.
 Insulation Resistance: >500M Ohm min.
 Contact Thickness: 0,25mm

Material:

Insulator : look order code
 Color: look order code
 Contact Material: look order code
 Contact Type: Stamped
 Contact Plating: look order code
 Shielding: look order code
 Lifetime: 5000 cycles min.
 Force: 35N Max.

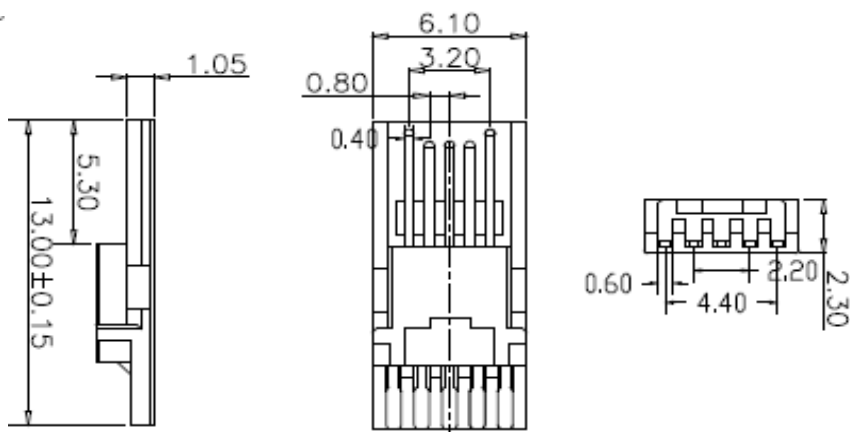

Drawing (dimensions all into mm)

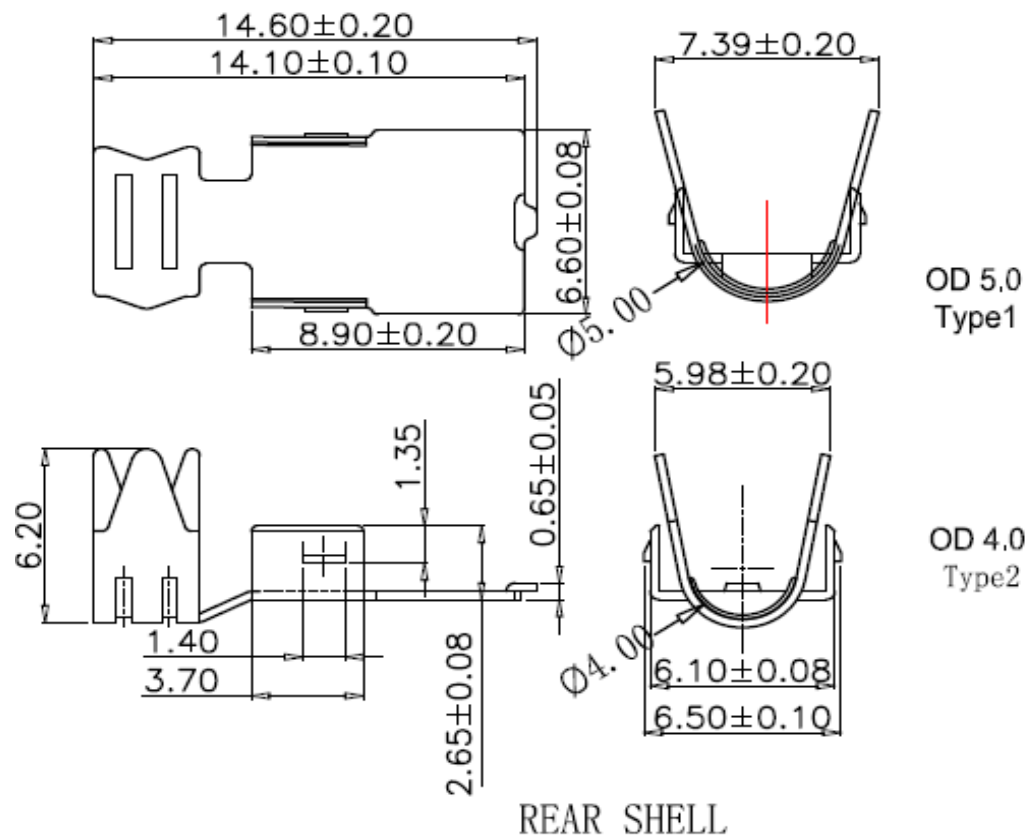

**Mini USB Connector Plug 5P B
 Type Solder Assembly Slim
 Type 2**

Part No.: **T64096**

DRW:	Jason	CHKD	Wilson	MATL:	Wilson	TOLERANCE	Mason	DATE	24.08.2015	Customer:
APPD:	Schumi			FINISH	Jamy		Sheet No.	1 from 4		

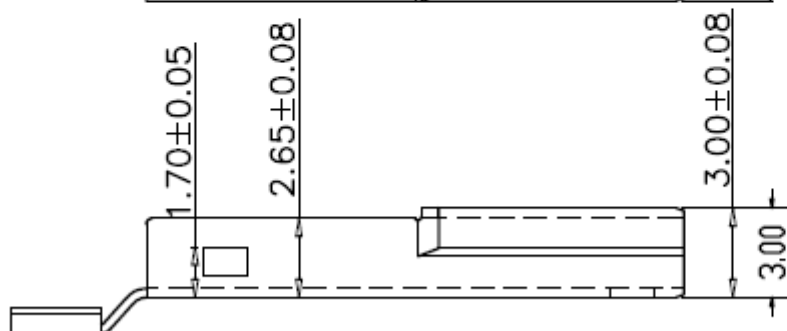
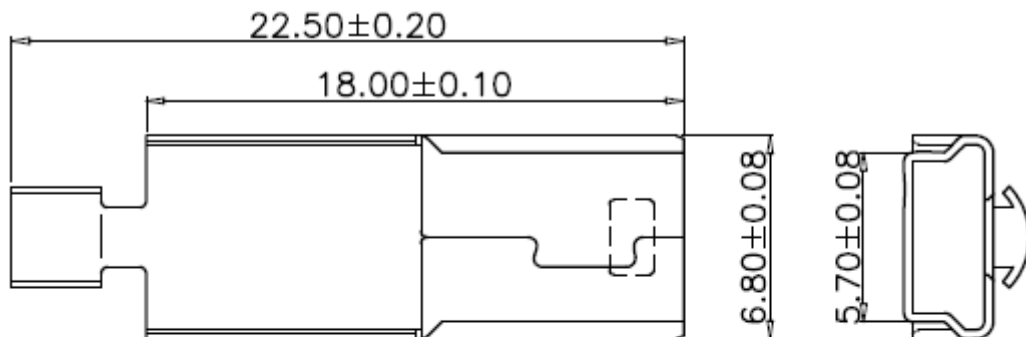

Front Shell

Straight Tail
Type1

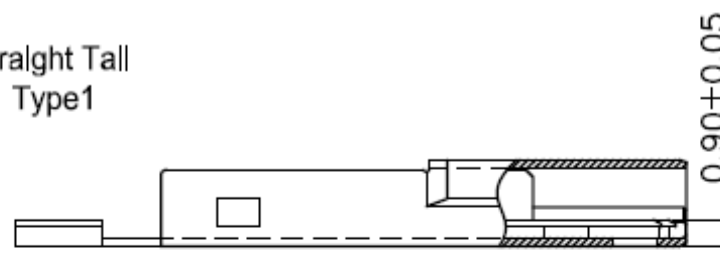

Bend Tail
Type2

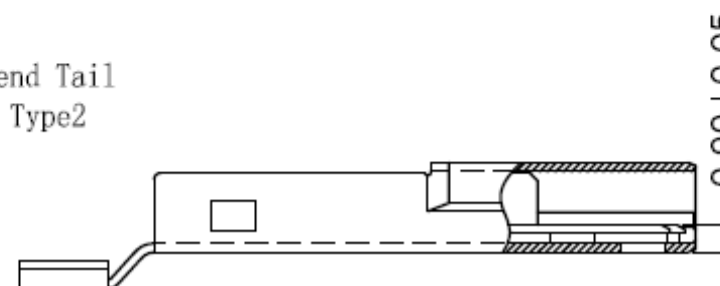

Mini USB Connector Plug 5P B
Type Solder Assembly Slim
Type 2

Part No.: T64096

DRW:	Jason	CHKD	Wilson	MATL:	Wilson	TOLERANCE	Mason	DATE	24.08.2015
APPD:	Schumi			FINISH	Jamy		Sheet No.	2 from 4	Customer:

EDCON-COMPONENTS



Ordering Informations

Serie	Color Inside	Shell Material	Insulator Material	Contact Material	Contact Plating	Special function	Packing	Packing		
T64096	BK	B	P	B	G0	0	R	BU		

BK= Black Color	B= Brass	P= PBT + 30% GF	B= Brass	G0= Gold Flash (Standard)	0= No Special function	R= ROHS conform N= NON ROHS conform	BU= Bulk Ware	
WH= White Color	I= Iron	L= LCP	P= Phosphor Copper	G1= 3μ Gold			TY= Tray Packing TR= Tape / Reel w. Pic and Place Foil	
	S= Stainless Steel			G1= 5μ Gold				
				G1= 10μ Gold				IV= Individual Packing
				G1= 15μ Gold				
				G1= 30μ Gold				

PIC and PLACE FOIL for automatic assembly machine



**Mini USB Connector Plug 5P B
Type Solder Assembly Slim
Type 2**

Part No.: **T64096**

DRW:	Jason	CHKD	Wilson	MATL:	Wilson	TOLERANCE	Mason	DATE	24.08.2015
APPD:	Schumi			FINISH	Jamy		Sheet No.		3 from 4

Customer:



Soldering Profile Curve

Classification Reflow Profile (JEDEC J-STD-020C)

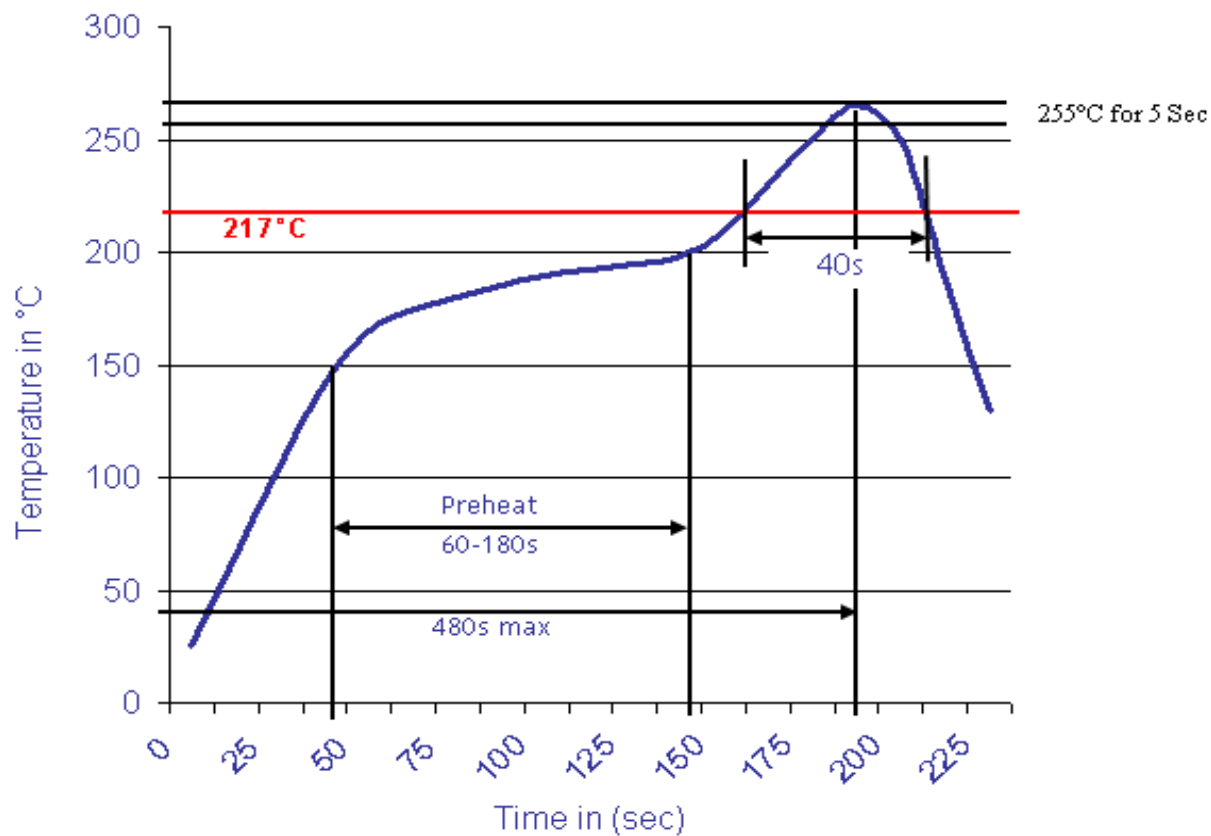

Mini USB Connector Plug
5P B Type Solder
Assembly Slim Type 2
 Part No.: T64096

DRW:	Jason	CHKD	Wilson	MATL:	Wilson	TOLERANCE	Mason	DATE	24.08.2015
APPD:	Schumi			FINISH	Jamy		Sheet No.	4 from 4	Customer: