

EDCON-COMPONENTS

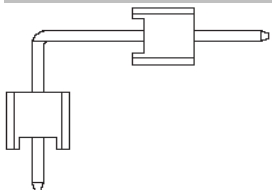

Specifications

Current Rating:	1 Ampere
Insulator Resistance:	5000 Megaohm min.
Contact Resistance	20m Ohm max.
Dielectric Withstanding:	AC 500V
Operating Temperature:	.-65°C to +125°C
Contact Material:	Brass
Insulator Material:	Polyester, UL 94V-0
Standard:	PBT
Contact Plating:	Tin, Gold or Selective Plated
Standard:	Gold Flash Overall

P.C.B Layout



Drawing

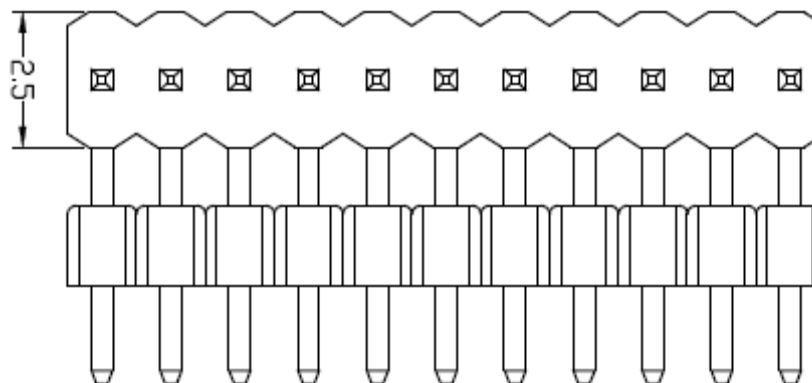
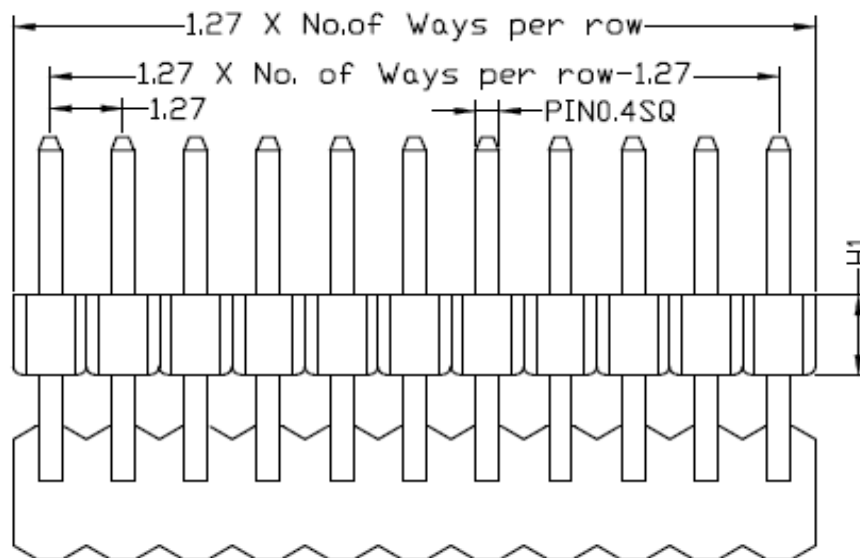

Male Header Pitch 1,27mm

Part No.: **T27C1101-**

Customer:

DRW:	Jason	CHKD	Wilson	MATL:	Wilson	TOLERANCE	Mason	DATE	01.05.2017
APPD:	Schumi			FINISH	Jamy		Sheet No.		1 from 4

EDCON-COMPONENTS

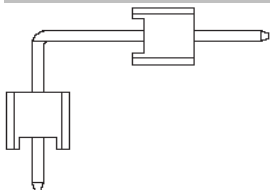

Pin Code length table free configuration

Order Code	Dimension (mm)			
	A	B	D1	D2
A01	3,00	1,80	2,50	2,50
A02	3,00	1,80	2,75	2,75
A03	3,00	1,80	3,00	3,00
A04	3,00	1,80	3,50	3,50
A05	3,00	1,80	4,00	4,00
A06	4,00	1,80	2,50	2,50
A07	4,00	1,80	2,75	2,75
A08	4,00	1,80	3,00	3,00
A09	4,00	1,80	3,50	3,50
A10	4,00	1,80	4,00	4,00
A11				
A12				
A13				
A14				
A15				
A16				
A17				
A18				
A19				
A20				
A21				
A22				

Order Code	Dimension (mm)			
	A	B	C	D
A23				
A24				
A25				
A26				
A27				
A28				
A29				
A30				
A31				
A32				
A33				
A34				
A35				
A36				
A37				
A38				
A39				
A40				
A41				
A42				
A43				
A44				

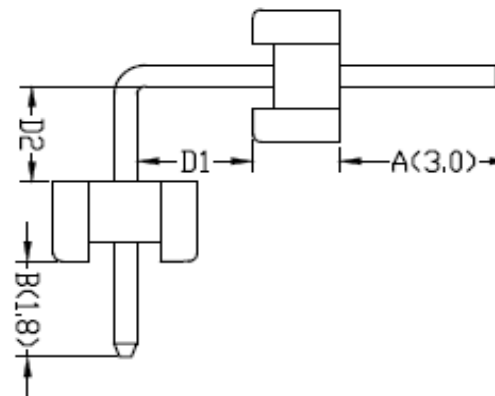

Male Header Pitch 1,27mm

X=	X.X=	X.XX=	X.XXX=
±0,35	±0,25	±0,20	±0,15
TOLERANCE	Mason	DATE	01.05.2017
Sheet No.			2 from 4

DRW:	Jason	CHKD	Wilson	MATL:	Wilson
APPD:	Schumi			FINISH	Jamy

Part No.: **T27C1101-**
Customer:

EDCON-COMPONENTS

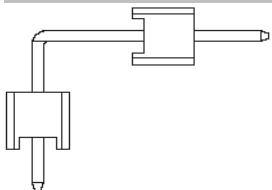

Ordering Informations

Serie	No. of Pos.	Construction	Contact Plating	Insulator Material	Special function	Pin Length Code	ROHS	Packing		
T27C1101-	02	RT	G0	PB	1	A01	R	BU		

02 to 50 Pos.	RS= Right angle THT	G0= Gold Flash (Standard) T0= Tin plated T0= Tin plated GA= 3µ Gold Plating GB= 5µ Gold Plating GC= 10µ Gold Plating GD= 15µ Gold Plating GE= 20µ Gold Plating GF= 30µ Gold Plating S0= Selectiv Plating Gold Flash / Tin	PB= P.B.T NY= Nylon-6T PA= PA-46 LC= LCP	1= Plastic Thickness H1=1,5mm	look Table No. 1	N= NO ROHS conform R= ROHS conform	BU= Bulk (Standard) TU= Tube w/o Cap TY= Tray packing w/o Cap
----------------------	----------------------------	--	---	--------------------------------------	------------------	---	--

Male Header Pitch 1,27mm

Part No.: **T27C1101-**
Customer:

DRW:	Jason	CHKD	Wilson	MATL:	Wilson	TOLERANCE	Mason	DATE	01.05.2017
APPD:	Schumi			FINISH	Jamy		Sheet No.		3 from 4

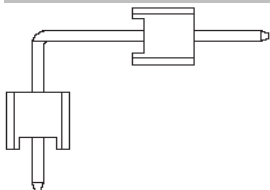

Soldering Profile for Lead Soldering (P.B.T.)

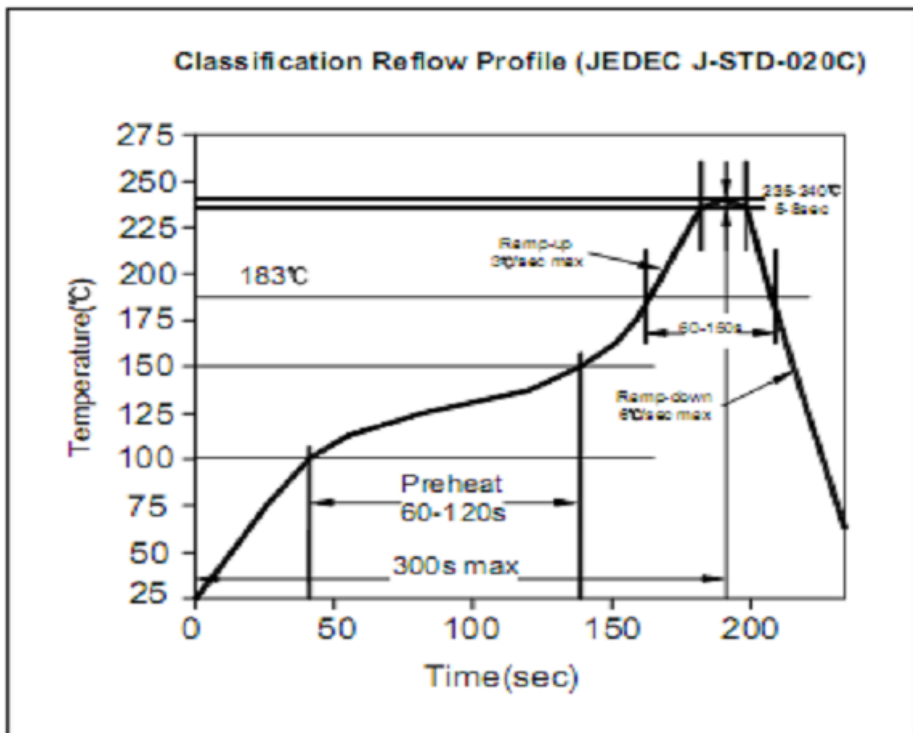

Soldering Profile for Lead Free Soldering (Nylon 6T)

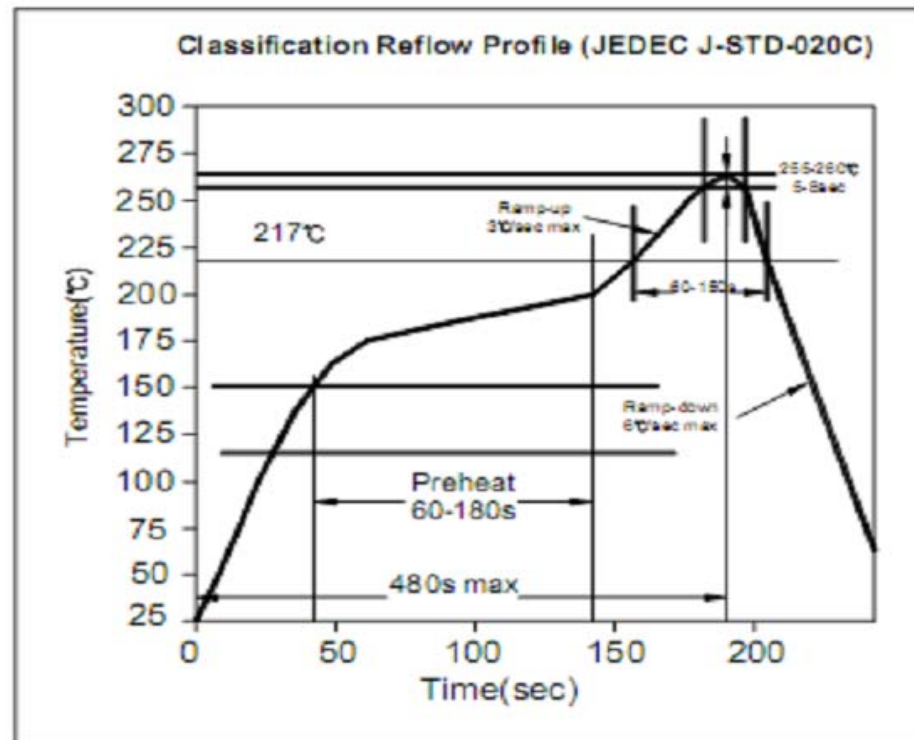

Male Header Pitch 1,27mm

Part No.: **T27C1101-**

Customer:

DRW:	Jason	CHKD	Wilson	MATL:	Wilson	TOLERANCE	Mason	DATE	01.05.2017
APPD:	Schumi			FINISH	Jamy		Sheet No.	4 from 4	