

EDCON-COMPONENTS

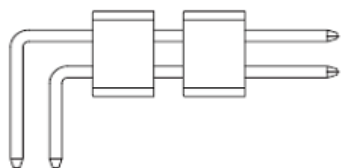

Specifications

| | |
|--------------------------|-------------------------------|
| Current Rating: | 1 Ampere |
| Insulator Resistance: | 5000 Megaohm min. |
| Contact Resistance: | 20m Ohm max. |
| Dielectric Withstanding: | AC 500V |
| Operating Temperature: | -.65°C to +125°C |
| Contact Material: | Brass |
| Insulator Material: | Polyester, UL 94V-0 |
| Standard: | PBT |
| Contact Plating: | Tin, Gold or Selective Plated |
| Standard: | Gold Flash Overall |

P.C.B Layout

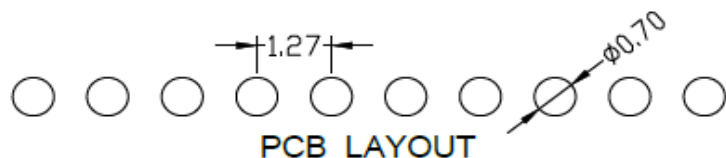

Drawing

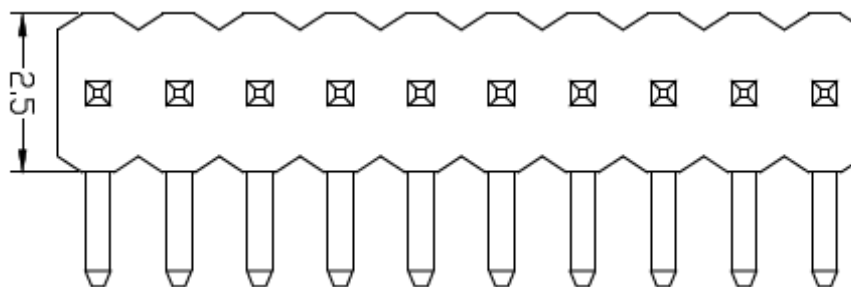
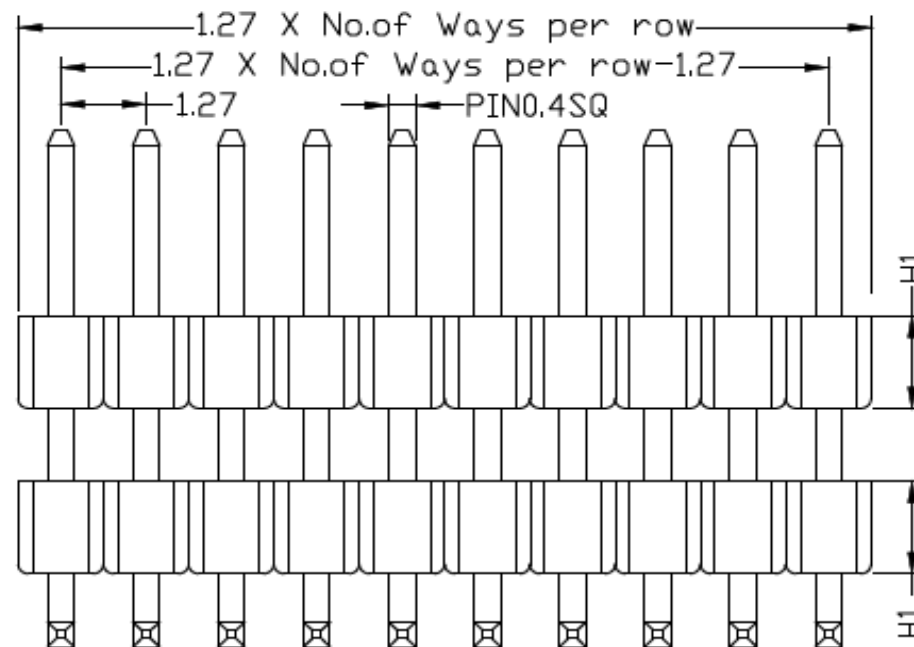

Male Header Pitch 1,27mm

Part No.: **T27C1099-**

Customer:

| | | | | | | | | | |
|-------|--------|------|--------|--------|--------|-----------|-----------|----------|------------|
| DRW: | Jason | CHKD | Wilson | MATL: | Wilson | TOLERANCE | Mason | DATE | 01.05.2017 |
| APPD: | Schumi | | | FINISH | Jamy | | Sheet No. | 1 from 4 | |

EDCON-COMPONENTS

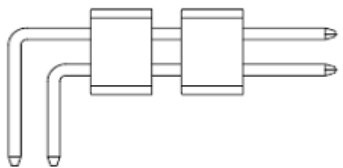

Pin Code length table free configuration

| Order Code | Dimension (mm) | | | |
|------------|----------------|------|------|------|
| | A | B | C | D |
| A01 | 3,00 | 1,80 | 1,00 | 1,30 |
| A02 | 3,00 | 1,80 | 1,00 | 2,00 |
| A03 | 3,00 | 1,80 | 1,00 | 2,50 |
| A04 | 3,00 | 1,80 | 1,00 | 3,00 |
| A05 | 3,00 | 1,80 | 1,00 | 3,50 |
| A06 | 4,00 | 1,80 | 1,00 | 1,30 |
| A07 | 4,00 | 1,80 | 1,00 | 2,00 |
| A08 | 4,00 | 1,80 | 1,00 | 2,50 |
| A09 | 4,00 | 1,80 | 1,00 | 3,00 |
| A10 | 4,00 | 1,80 | 1,00 | 3,50 |
| A11 | | | | |
| A12 | | | | |
| A13 | | | | |
| A14 | | | | |
| A15 | | | | |
| A16 | | | | |
| A17 | | | | |
| A18 | | | | |
| A19 | | | | |
| A20 | | | | |
| A21 | | | | |
| A22 | | | | |

| Order Code | Dimension (mm) | | | |
|------------|----------------|---|---|---|
| | A | B | C | D |
| A23 | | | | |
| A24 | | | | |
| A25 | | | | |
| A26 | | | | |
| A27 | | | | |
| A28 | | | | |
| A29 | | | | |
| A30 | | | | |
| A31 | | | | |
| A32 | | | | |
| A33 | | | | |
| A34 | | | | |
| A35 | | | | |
| A36 | | | | |
| A37 | | | | |
| A38 | | | | |
| A39 | | | | |
| A40 | | | | |
| A41 | | | | |
| A42 | | | | |
| A43 | | | | |
| A44 | | | | |

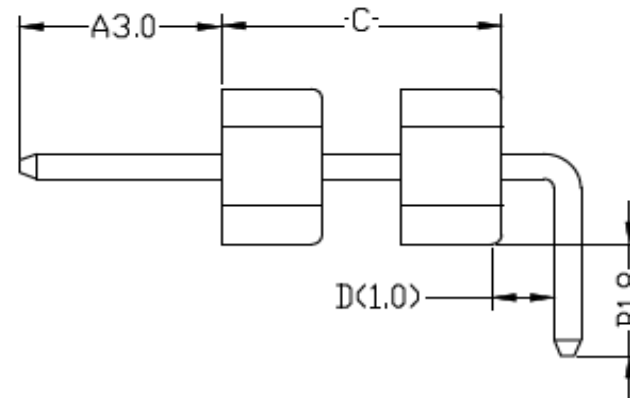

Male Header Pitch 1,27mm

| X= | X.X= | X.XX= | X.XXX= |
|-----------|-------|-------|------------|
| ±0,35 | ±0,25 | ±0,20 | ±0,15 |
| TOLERANCE | Mason | DATE | 01.05.2017 |
| Sheet No. | | | 2 from 4 |

Part No.: **T27C1099-**

Customer:

| | | | | | |
|-------|--------|------|--------|--------|--------|
| DRW: | Jason | CHKD | Wilson | MATL: | Wilson |
| APPD: | Schumi | | | FINISH | Jamy |

EDCON-COMPONENTS

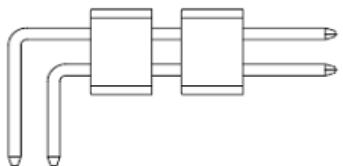

Ordering Informations

| Serie | No. of Pos. | Construction | Contact Plating | Insulator Material | Special function | Pin Length Code | ROHS | Packing | | |
|------------------|-------------|--------------|-----------------|--------------------|------------------|-----------------|----------|-----------|--|--|
| T27C1099- | 02 | RT | G0 | PB | 1 | A01 | R | BU | | |

| | | | | | | | |
|----------------------|----------------------------|--|---|---------------------------------------|------------------|---|--|
| 02 to 50 Pos. | RS= Right angle THT | G0= Gold Flash (Standard) T0= Tin plated T0= Tin plated GA= 3µ Gold Plating GB= 5µ Gold Plating GC= 10µ Gold Plating GD= 15µ Gold Plating GE= 20µ Gold Plating GF= 30µ Gold Plating S0= Selectiv Plating Gold Flash / Tin | PB= P.B.T NY= Nylon-6T PA= PA-46 LC= LCP | 1= Plastic Thickness H1=0,65mm | look Table No. 1 | N= NO ROHS conform R= ROHS conform | BU= Bulk (Standard) TU= Tube w/o Cap TY= Tray packing w/o Cap |
|----------------------|----------------------------|--|---|---------------------------------------|------------------|---|--|

Male Header Pitch 1,27mm

Part No.: **T27C1099-**

| | | | | | | | | | |
|-------|--------|------|--------|--------|--------|-----------|-----------|------|------------|
| DRW: | Jason | CHKD | Wilson | MATL: | Wilson | TOLERANCE | Mason | DATE | 01.05.2017 |
| APPD: | Schumi | | | FINISH | Jamy | | Sheet No. | | 3 from 4 |

Customer:

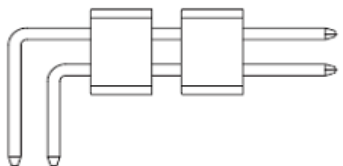

Soldering Profile for Lead Soldering (P.B.T.)

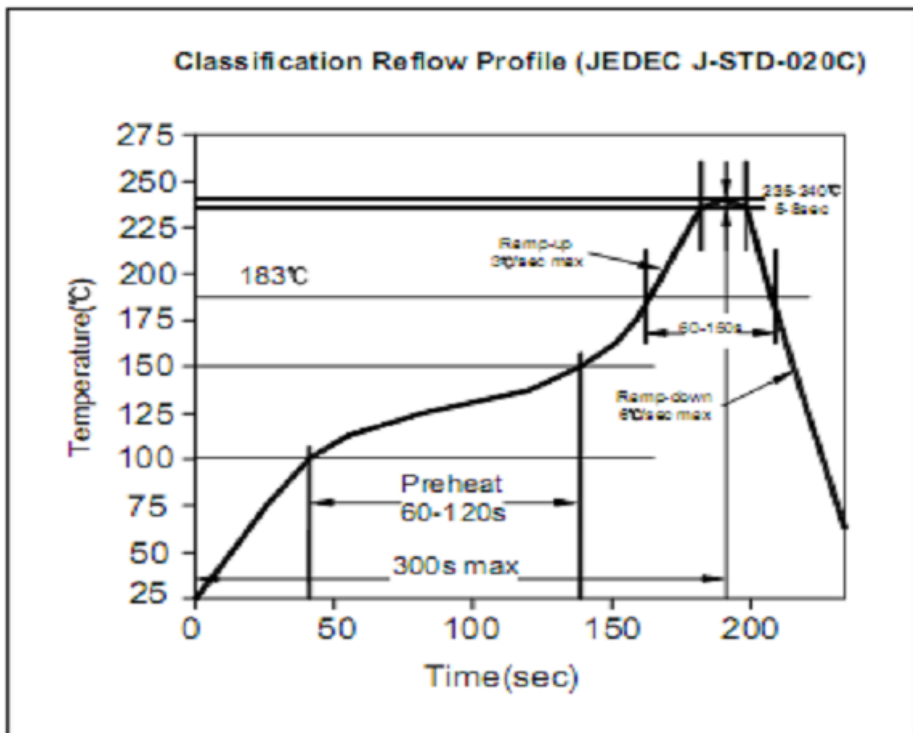

Soldering Profile for Lead Free Soldering (Nylon 6T)

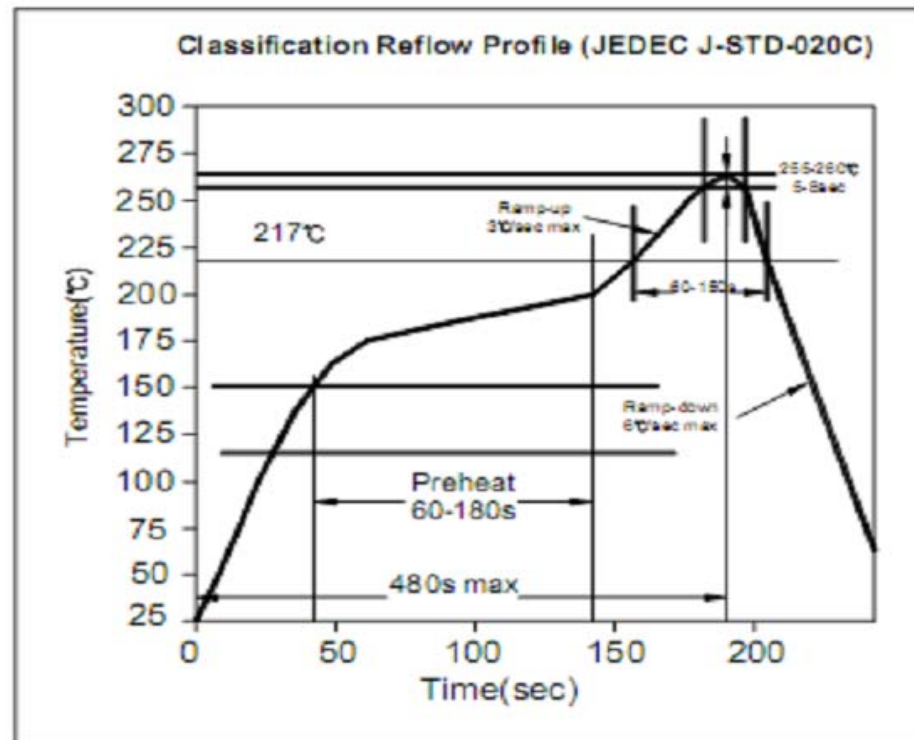

Male Header Pitch 1,27mm

Part No.: T27C1099-

| | | | | | | | | | |
|-------|--------|------|--------|--------|--------|-----------|-----------|----------|------------|
| DRW: | Jason | CHKD | Wilson | MATL: | Wilson | TOLERANCE | Mason | DATE | 01.05.2017 |
| APPD: | Schumi | | | FINISH | Jamy | | Sheet No. | 4 from 4 | Customer: |