

EDCON-COMPONENTS

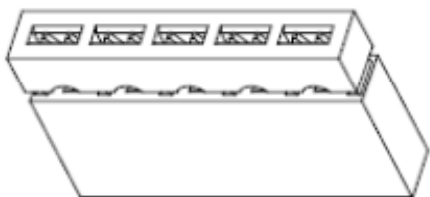

Description

Current Rating: 1,0A
 Insulation Resistance: 1000MΩ min.
 Contact Resistance: 20MΩ max.
 Withstanding Voltage: 500V AC/DC
 Operating Temperature: -40°C to +105°C
 Contact Material: Phosphor Bronze
 Contact Plating: Au Over Ni
 Insulator Material: PBT +30% GF UL94V-0

Dimensions (mm)

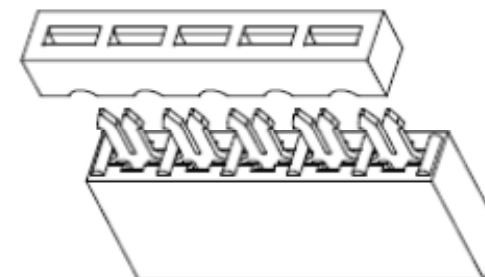
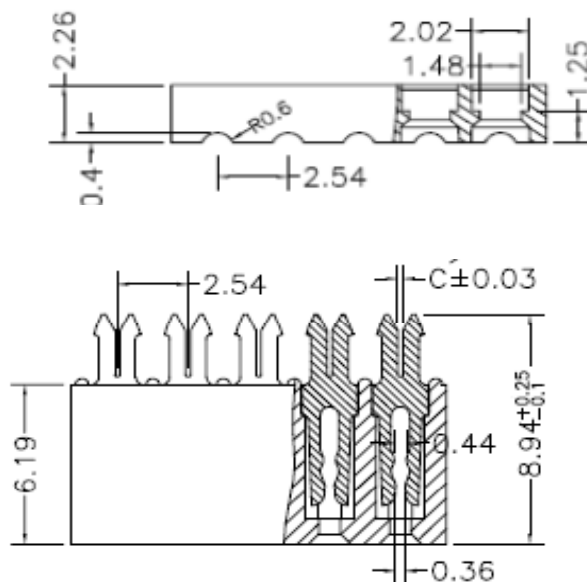
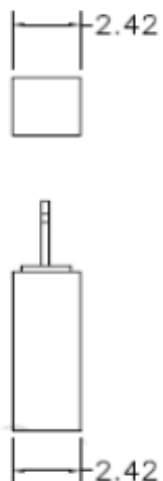

**IDC-Connector Single Row
Pitch 2,54mm**

Part No.: **T33A1009**

DRW:	Jason	CHKD	Wilson	MATL:	Wilson	TOLERANCE	Mason	DATE	26.09.2017	Customer:
APPD:	Schumi			FINISH	Jamy		Sheet No.	1 from 3		

EDCON-COMPONENTS

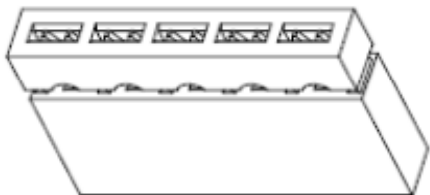

No. o. Pos.	A	B
2	2,54	5,84
3	5,08	8,38
4	7,62	10,92
5	10,16	13,46
6	12,70	16
7	15,24	18,54
8	17,78	21,08
9	20,32	23,62
10	22,86	26,16
11	25,40	28,7
12	27,94	31,24
13	30,48	33,78
14	33,02	36,32
15	35,56	38,86
16	38,10	41,4
17	40,64	43,94
18	43,18	46,48
19	45,72	49,02
20	48,26	51,56
21	50,80	54,1
22	53,34	56,64
23	55,88	59,18
24	58,42	61,72

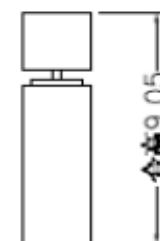
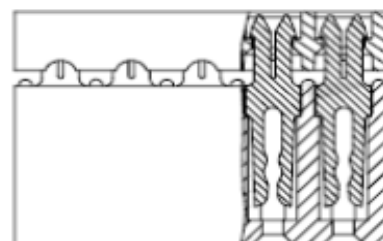
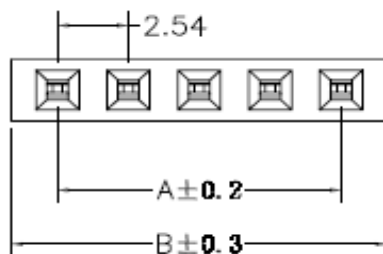

**IDC-Connector Single Row
Pitch 2,54mm**

Part No.: **T33A1009**

DRW:	Jason	CHKD	Wilson	MATL:	Wilson	TOLERANCE	Mason	DATE	26.09.2017
APPD:	Schumi			FINISH	Jamy		Sheet No.	2 from 3	Customer:

EDCON-COMPONENTS

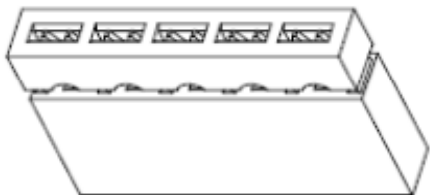

Ordering Information

Serie	No. Off Position	Contact Plating	Body Colour	Special Function	Special Function	ROHS	Packing			
T33A1009	xx	TN	BK	N	N	R	BU			

xx= Like Position Table	TN= Tin Plated	BK= Black	N= No Function	N= No Function	R= ROHS Conform	BU= Bulk - Ware into Polybag
	G1= 3µ Gold	GY= Gray			N= NON ROHS Conform	
	G2= 5µ Gold		IV= Individual Packing			
	G3= 10µ Gold					
	G4= 15µ Gold					
	G5= 30µ Gold					
	S0= Selectiv Gold Flash					
	S1= Selectiv 3µ Gold					
	S2= Selectiv 5µ Gold					
	S3= Selectiv 10µ Gold					
S4= Selectiv 15µ Gold	S5= Selectiv 30µ Gold					

**IDC-Connector Single Row
Pitch 2,54mm**
Part No.: **T33A1009**

DRW:	Jason	CHKD	Wilson	MATL:	Wilson	TOLERANCE	Mason	DATE	26.09.2017	Customer:
APPD:	Schumi			FINISH	Jamy		Sheet No.	3 from 3		