

# EDCON-COMPONENTS

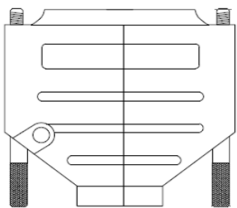

## Description

Material: Zinc Alloy  
 Finished: Chromate plated

## Dimensions (mm)

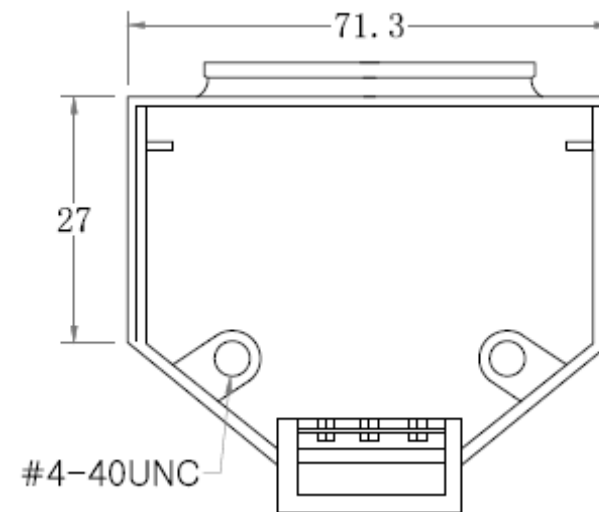
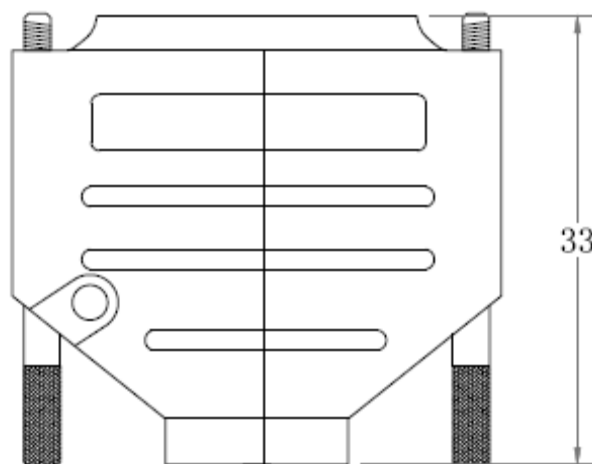
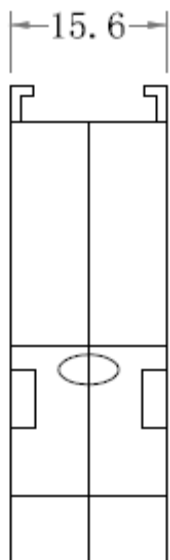

**37Pos. Full Metal Hood Cable  
 Entry 180° H-Type**

Part No.: **T31044**

DRW:	Jason	CHKD	Wilson	MATL:	Wilson	TOLERANCE	Mason	DATE	25.12.2015
APPD:	Schumi			FINISH	Jamy		Sheet No.	1 from 3	Customer:

[www.edcon-components.com](http://www.edcon-components.com)

email: [info@edcon-components.com](mailto:info@edcon-components.com)

# EDCON-COMPONENTS

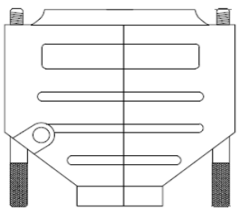

## Hardware of D-Sub Hood

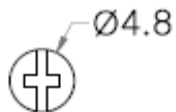
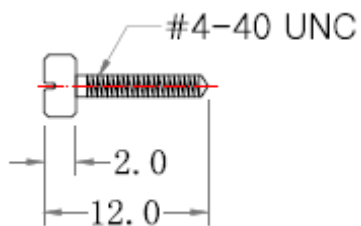
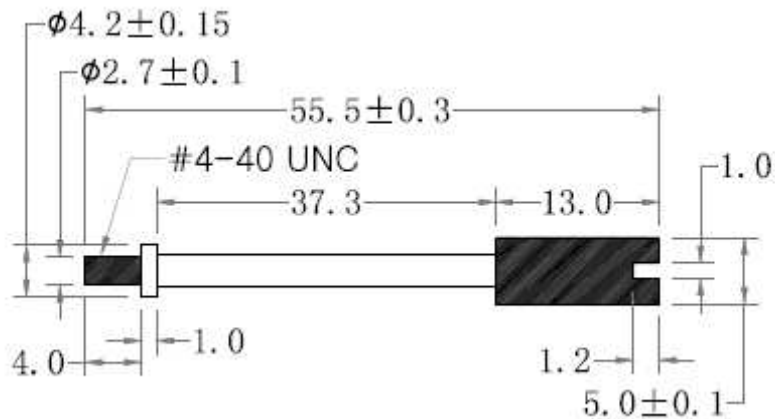
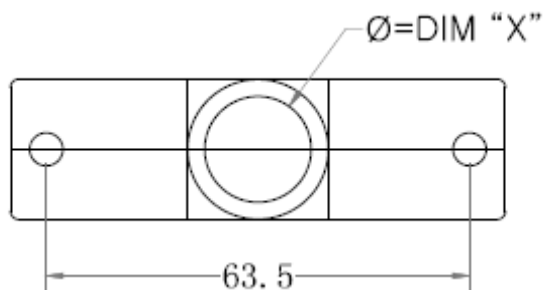

**37Pos. Full Metal Hood Cable  
Entry 180° H-Type**

Part No.: **T31044**

Customer:

DRW:	Jason	CHKD	Wilson	MATL:	Wilson	TOLERANCE	Mason	DATE	25.12.2015
APPD:	Schumi			FINISH	Jamy		Sheet No.	2 from 3	

# EDCON-COMPONENTS

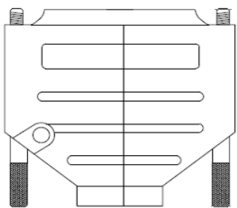

## Ordering Informations

Serie	Pos.	Cable Entry Diameter	Srew Type	ROHS	Packing					
-------	------	----------------------	-----------	------	---------	--	--	--	--	--

<b>T31044</b>	-	<b>37</b>	<b>K</b>	<b>L</b>	<b>R</b>	<b>1</b>				
---------------	---	-----------	----------	----------	----------	----------	--	--	--	--

<b>37= D-Sub-Type</b>	<b>K= 10,5mm</b>	<b>L= Long Screws</b>	<b>R= ROHS Conform</b>	<b>1= Mix Packing</b>
	<b>P= 13,0mm</b>		<b>N= NON ROHS Conform</b>	

<b>37Pos. Full Metal Hood Cable Entry 180° H-Type</b>	
Part No.:	<b>T31044</b>
Customer:	

DRW:	Jason	CHKD	Wilson	MATL:	Wilson	TOLERANCE	Mason	DATE	25.12.2015
APPD:	Schumi			FINISH	Jamy			Sheet No.	3 from 3