

# EDCON-COMPONENTS

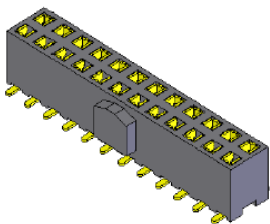

## Specifications

Current Rating: 1,5 Ampere  
 Insulator Resistance: 5000 Megaohm min.  
 Contact Resistance: 20m Ohm max.  
 Dielectric Withstanding: AC 500V  
 Operating Temperature: -65°C to +125°C  
 Contact Material: Brass  
 Insulator Material: PBT, UL 94V-0 Black

Contact Plating: Tin, Gold or Selective Plated  
 Standard: Gold Flash Overall

## P.C.B Layout

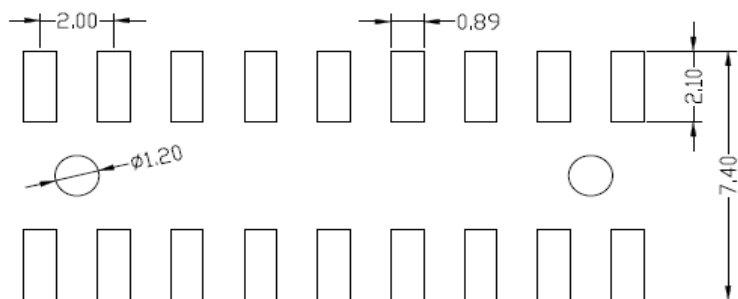

## Drawing

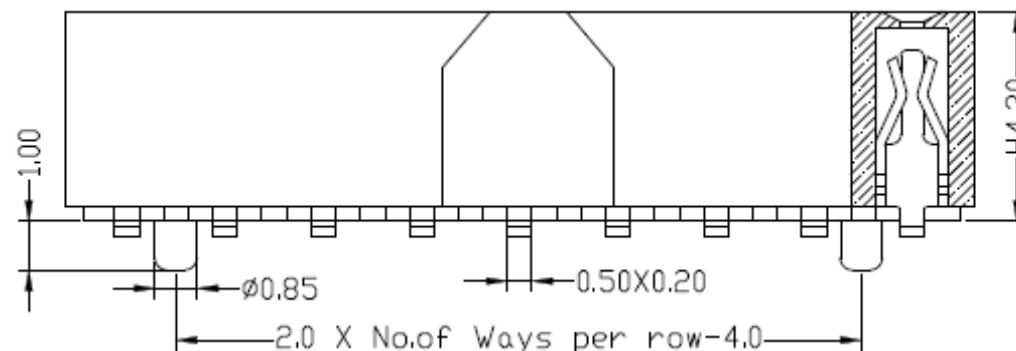
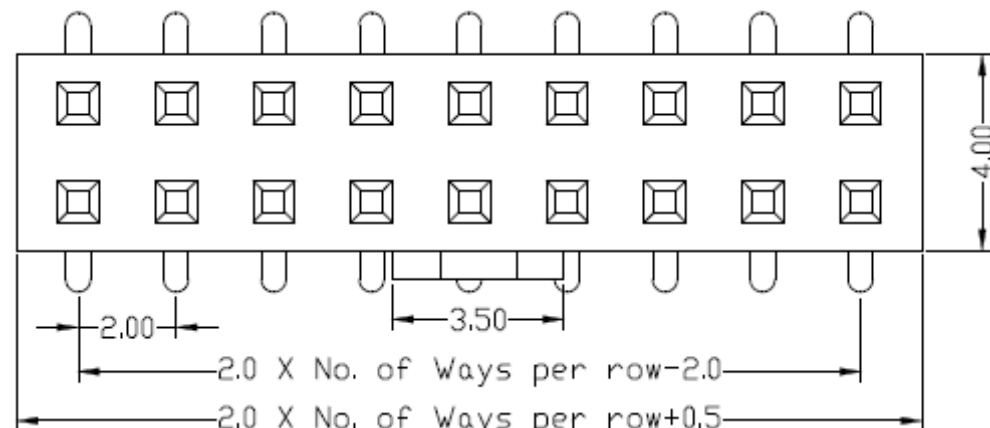

**Female Header Pitch  
2,00mm**

Unless: Otherwise specified tolerance (mm)			
X	XX	XXX	XXXX
± 0,35	± 0,25	± 0,20	± 0,15
TOLERANCE	Mason	DATE	03.10.2017
Sheet No.			1 from 4

Part No.: **T27B1100-**

Customer:

DRW:	Jason	CHKD	Wilson	MATL:	Wilson
APPD:	Schumi			FINISH	Jamy

# EDCON-COMPONENTS

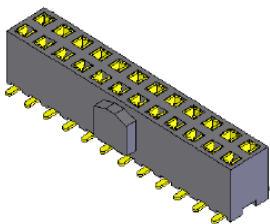

## Pin Code length table free configuration

Order Code	Dimension (mm)			
	W			
A01	6,20			
A02				
A03				
A04				
A05				
A06				
A07				
A08				
A09				
A10				
A11				
A12				
A13				
A14				
A15				
A16				
A17				
A18				
A19				
A20				
A21				
A22				

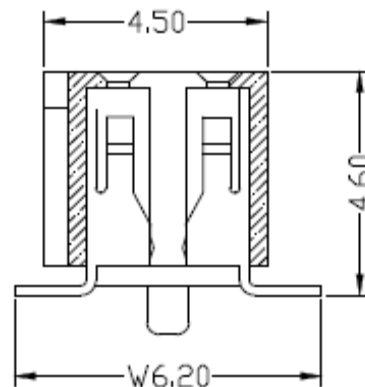

<b>Female Header Pitch 2,00mm</b>	
Part No.:	<b>T27B1100-</b>
Customer:	

DRW:	Jason	CHKD	Wilson	MATL:	Wilson	TOLERANCE	Mason	DATE	03.10.2017
APPD:	Schumi			FINISH	Jamy		Sheet No.	2 from 4	

# EDCON-COMPONENTS

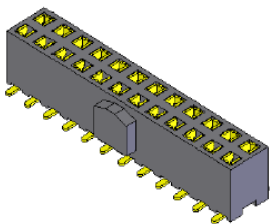

## Ordering Informations

Serie	No. of Pos.	Construction	Contact Plating	Material	Special function	Pin Length Code	ROHS	Packing		
<b>T27B1100-</b>	<b>XX</b>	<b>SS</b>	<b>G0</b>	<b>PB</b>	<b>N</b>	<b>A01</b>	<b>R</b>	<b>TU</b>		

<b>04 ~ 80Pos.</b>	<b>SS</b> Straight SMD	<b>G0</b> = Gold Flash (Standard)	<b>PB</b> = P.B.T	<b>N</b> = No special	look Table No. 1	<b>N</b> =NO ROHS conform	<b>BU</b> = Bulk (Standard)
		<b>T0</b> = Tin plated					<b>NY</b> = Nylon-6T
		<b>GA</b> = 10µ Gold Plating	<b>LC</b> = LCP	<b>P4</b> = PA46		<b>TC</b> = Tube w. pic and Place Cap	
		<b>GB</b> = 15µ Gold Plating				<b>TY</b> = Tray packing w/o Cap	
		<b>GC</b> = 20µ Gold Plating				<b>TR</b> = Tape/Reel w. pic and Place Cap	
		<b>S0</b> = Selectiv Plating Gold Flash / Tin					

<b>Female Header Pitch 2,00mm</b>	
Part No.:	<b>T27B1100-</b>
Customer:	

DRW:	Jason	CHKD	Wilson	MATL:	Wilson	TOLERANCE	Mason	DATE	03.10.2017
APPD:	Schumi			FINISH	Jamy		Sheet No.	3 from 4	

# EDCON-COMPONENTS

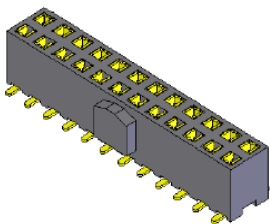

## Soldering Profile for Lead Soldering ( P.B.T. )

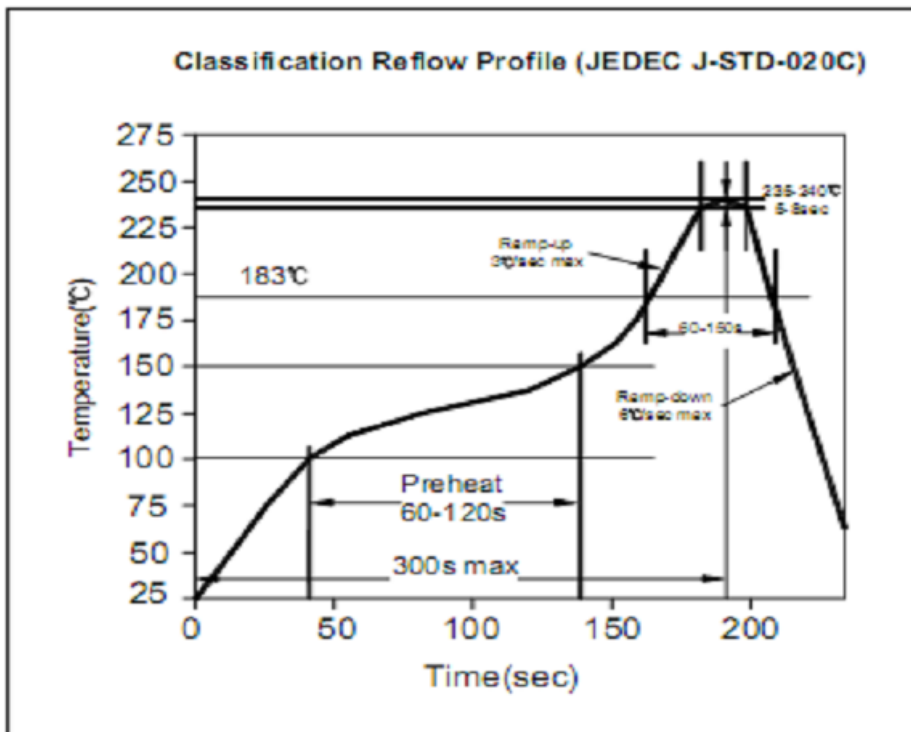

## Soldering Profile for Lead Free Soldering ( Nylon 6T )

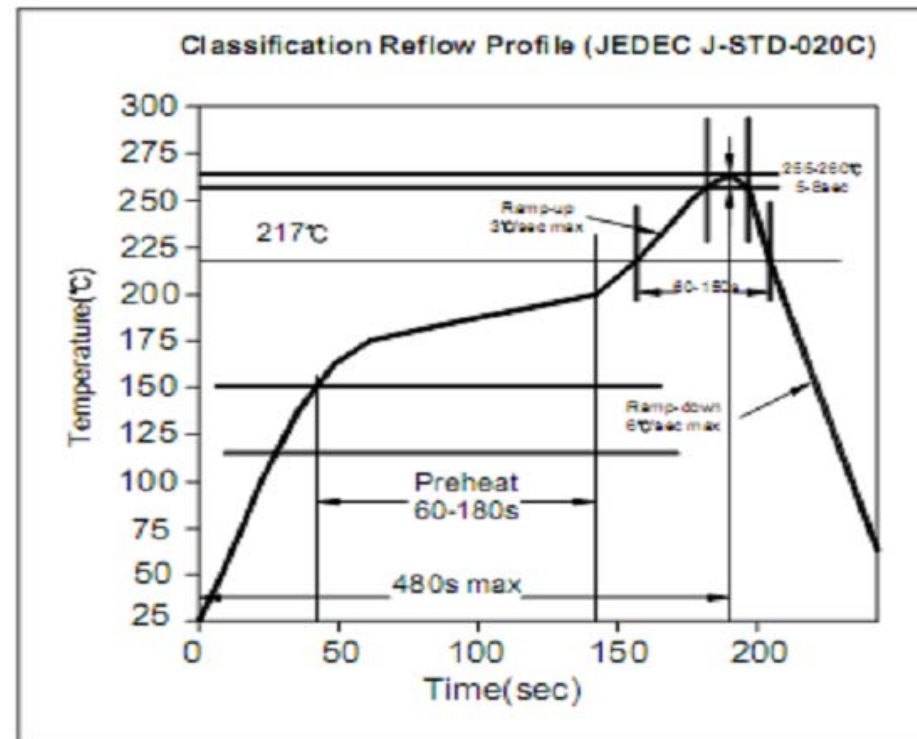

**Female Header Pitch  
2,00mm**

Part No.: **T27B1100-**

DRW:	Jason	CHKD	Wilson	MATL:	Wilson	TOLERANCE	Mason	DATE	03.10.2017
APPD:	Schumi			FINISH	Jamy		Sheet No.	4 from 4	Customer:

[www.edcon-components.com](http://www.edcon-components.com)

email: [info@edcon-components.com](mailto:info@edcon-components.com)