

EDCON-COMPONENTS

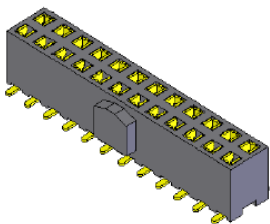

Specifications

Current Rating:	1,5 Ampere
Insulator Resistance:	5000 Megaohm min.
Contact Resistance:	20m Ohm max.
Dielectric Withstanding:	AC 500V
Operating Temperature:	.-65°C to +125°C
Contact Material:	Brass
Insulator Material:	PBT, UL 94V-0 Black
Contact Plating:	Tin, Gold or Selective Plated
Standard:	Gold Flash Overall

P.C.B Layout

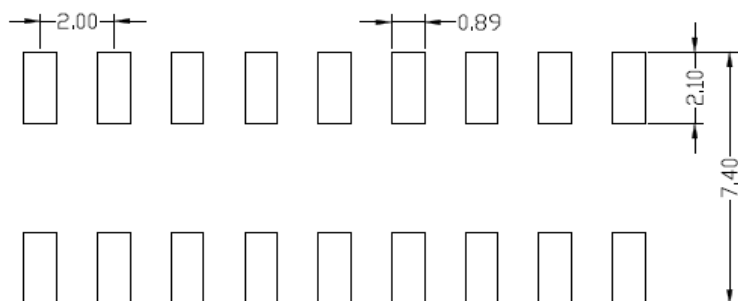

Drawing

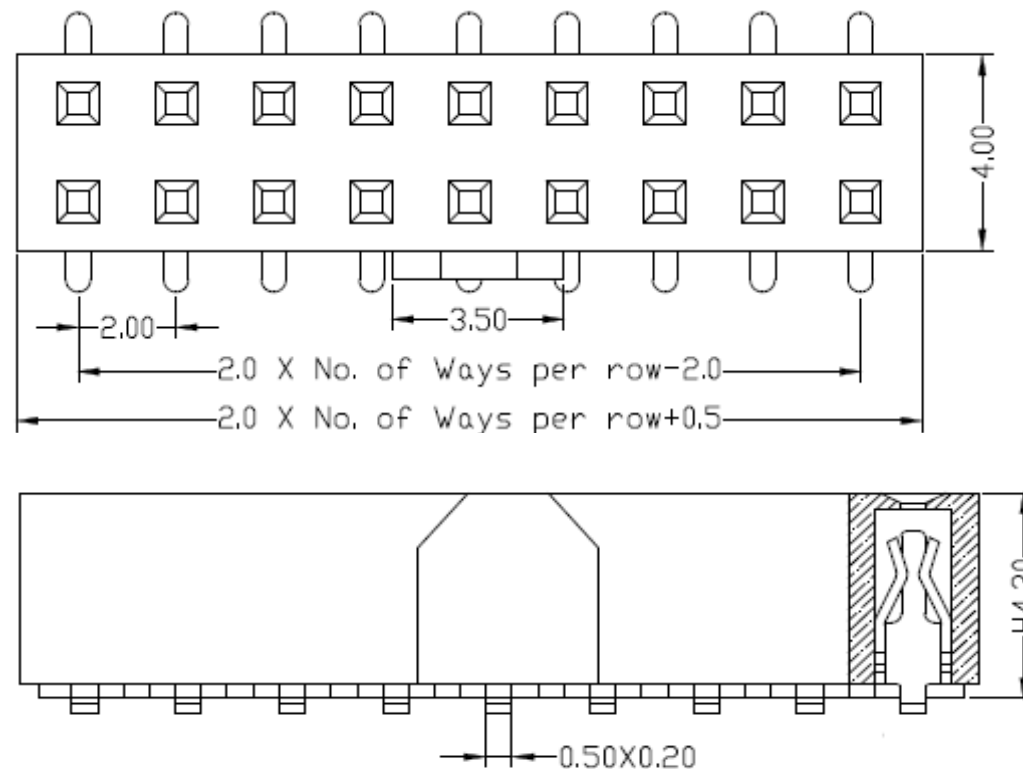

**Female Header Pitch
2,00mm**

Unless: Otherwise specified tolerance (mm)			
X	XX	XXX	XXXX
± 0,35	± 0,25	±0,20	±0,15
TOLERANCE	Mason	DATE	03.10.2017
Sheet No.			1 from 4

Part No.: **T27B1099-**

Customer:

DRW:	Jason	CHKD	Wilson	MATL:	Wilson
APPD:	Schumi			FINISH	Jamy

EDCON-COMPONENTS

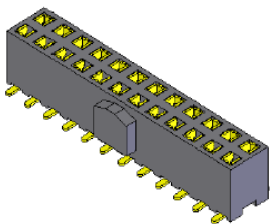

Pin Code length table free configuration

Order Code	Dimension (mm)			
	W			
A01	6,20			
A02				
A03				
A04				
A05				
A06				
A07				
A08				
A09				
A10				
A11				
A12				
A13				
A14				
A15				
A16				
A17				
A18				
A19				
A20				
A21				
A22				

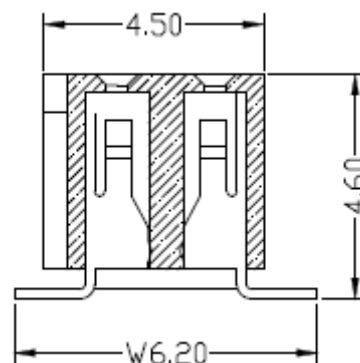

Female Header Pitch 2,00mm	
Part No.:	T27B1099-
Customer:	

DRW:	Jason	CHKD	Wilson	MATL:	Wilson	TOLERANCE	Mason	DATE	03.10.2017
APPD:	Schumi			FINISH	Jamy		Sheet No.	2 from 4	

EDCON-COMPONENTS

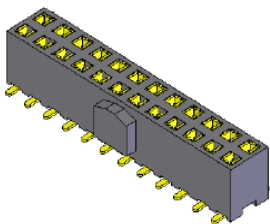

Ordering Informations

Serie	No. of Pos.	Construction	Contact Plating	Material	Special function	Pin Length Code	ROHS	Packing		
T27B1099-	XX	SS	G0	PB	N	A01	R	TU		

04 ~ 80Pos.	SS Straight SMD	G0 = Gold Flash (Standard)	PB = P.B.T	N = No special	look Table No. 1	N =NO ROHS conform	BU = Bulk (Standard)
		T0 = Tin plated					NY = Nylon-6T
		GA = 10µ Gold Plating	LC = LCP	P4 = PA46		TC = Tube w. pic and Place Cap	
		GB = 15µ Gold Plating				TY = Tray packing w/o Cap	
		GC = 20µ Gold Plating				TR = Tape/Reel w. pic and Place Cap	
		S0 = Selectiv Plating Gold Flash / Tin					

Female Header Pitch 2,00mm	
Part No.:	T27B1099-
Customer:	

DRW:	Jason	CHKD	Wilson	MATL:	Wilson	TOLERANCE	Mason	DATE	03.10.2017
APPD:	Schumi			FINISH	Jamy		Sheet No.		3 from 4

EDCON-COMPONENTS

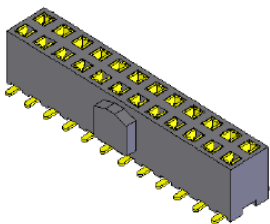

Soldering Profile for Lead Soldering (P.B.T.)

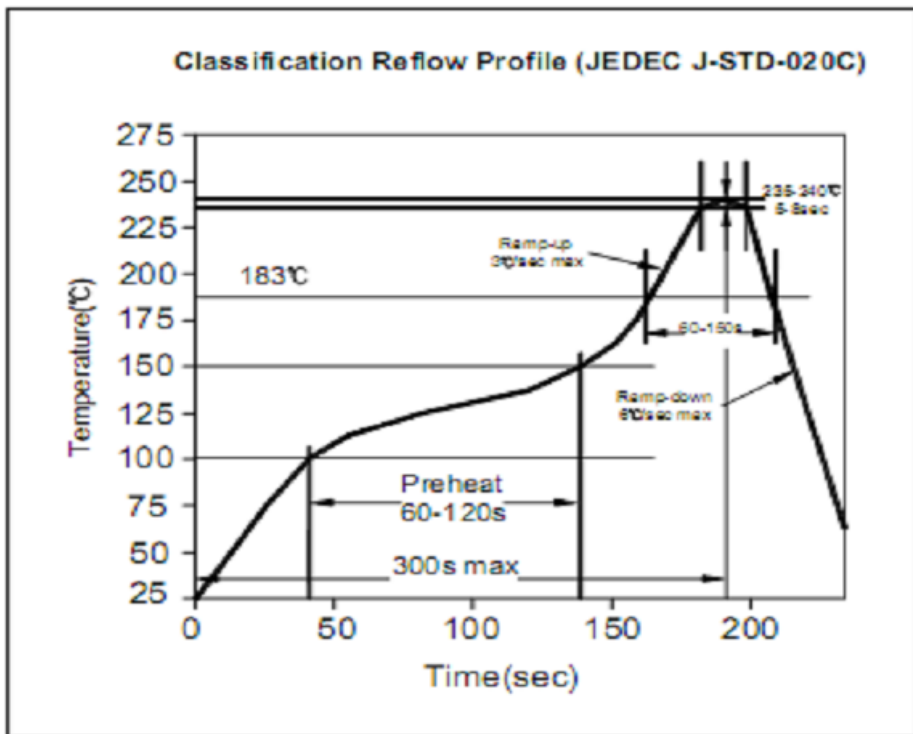

Soldering Profile for Lead Free Soldering (Nylon 6T)

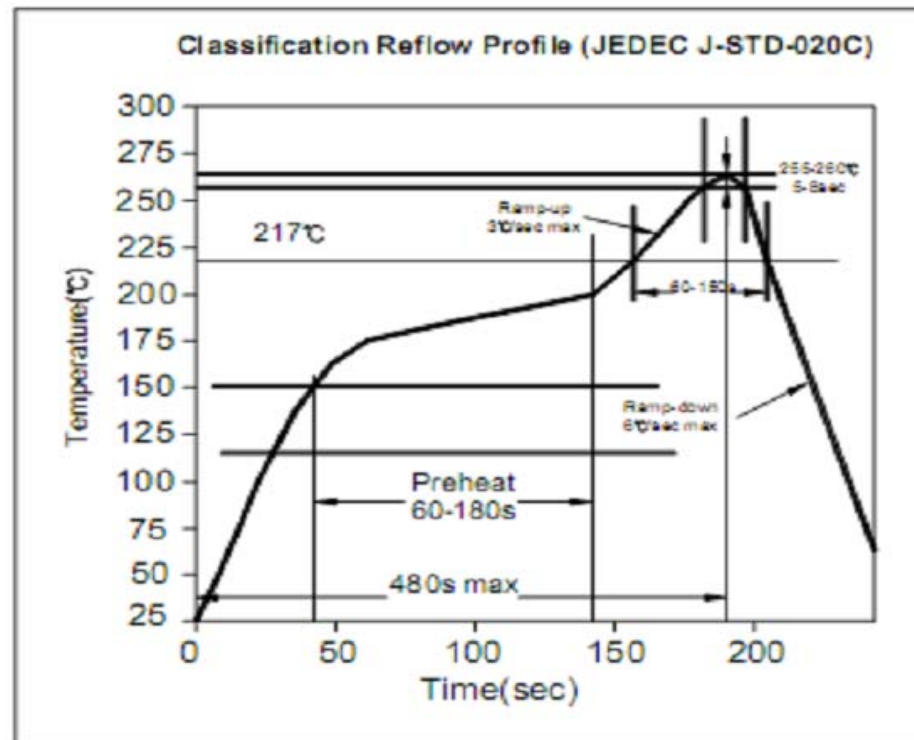

**Female Header Pitch
2,00mm**

Part No.: **T27B1099-**

DRW:	Jason	CHKD	Wilson	MATL:	Wilson	TOLERANCE	Mason	DATE	03.10.2017
APPD:	Schumi			FINISH	Jamy		Sheet No.	4 from 4	Customer: