

# EDCON-COMPONENTS

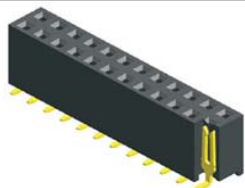

**Contact**



## Specifications

Current Rating:	3 Ampere
Insulator Resistance:	1000 Megaohm min.
Contact Resistance	20m Ohm max.
Dielectric Withstanding:	AC 500V
Operating Temperature:	.-40°C to +105°C
Contact Material:	Phosphor Bronze
Insulator Material:	Polyester, UL 94V-0
Standard:	PBT
Contact Plating:	Tin, Gold or Selective Plated
Standard:	Gold Flash Overall

## PCB Layout

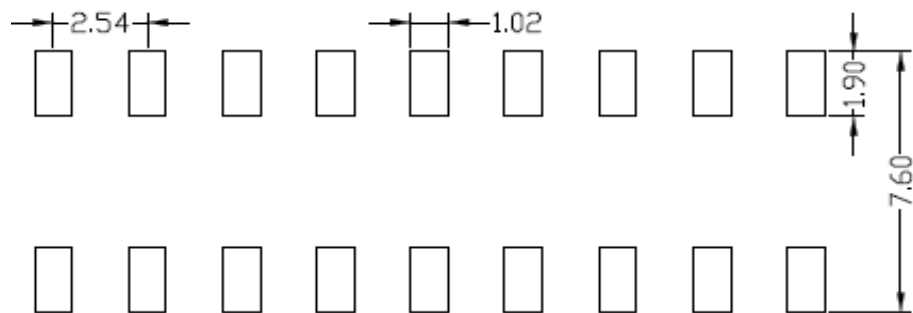

## Drawing (mm)

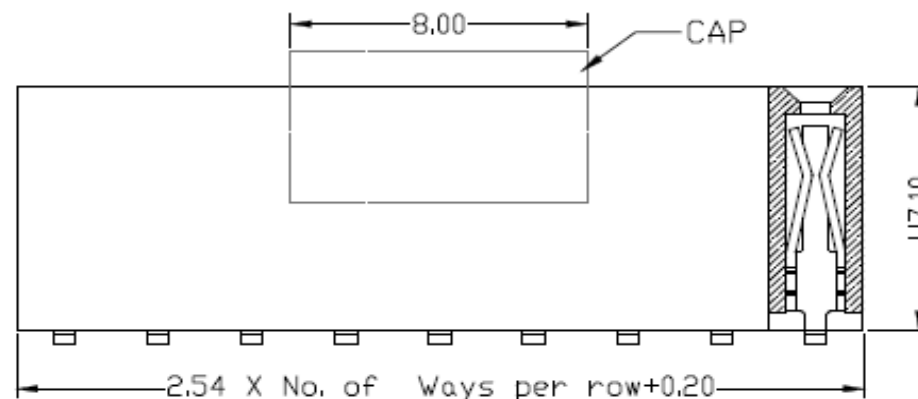
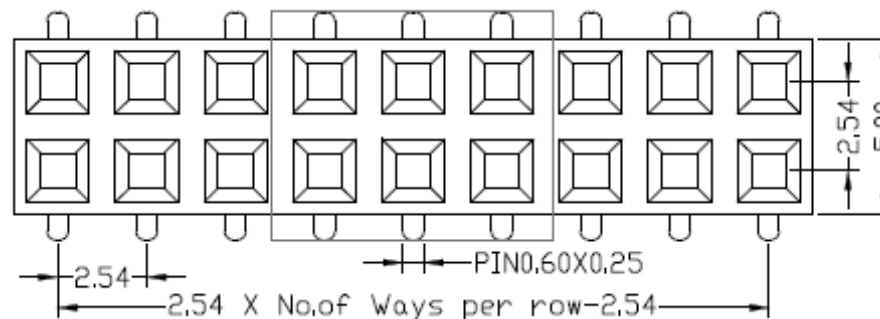

**Female Header Pitch  
2,54mm**

DRW:	JASON	CHKD	WILSON	MATL:	X=	X.X=	X.XX=	X.XXX=	Angle
APPD:	Schumi			FINISH	±0,35	±0,25	±0,20	±0,15	±5°
					Wilson	TOLERANCE	Mason	DATE	11.03.2018
					Jamy		Sheet No.		1 from 4

Part No.: **T27A1199-**

Customer:

# EDCON-COMPONENTS

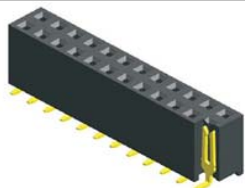

Pin Code length table 1 free configuration

Drawing (mm)

Order Code	Dimension (mm)			
	D			
A01	6,50			
A02				
A03				
A04				
A05				
A06				
A07				
A08				
A09				
A10				
A11				
A12				
A13				
A14				
A15				
A16				
A17				
A18				
A19				
A20				
A21				
A22				
A23				
A24				
A25				
A26				
A27				

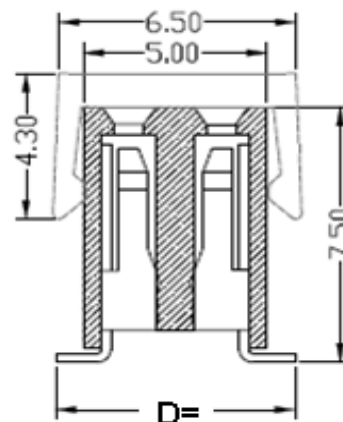

<b>Female Header Pitch 2,54mm</b>	
Part No.:	<b>T27A1199-</b>
Customer:	

DRW:	Jason	CHKD	Wilson	MATL:	Wilson	TOLERANCE	Mason	DATE	11.03.2018
APPD:	Schumi			FINISH	Jamy		Sheet No.		2 from 4

[www.edcon-components.com](http://www.edcon-components.com)

email: [info@edcon-components.com](mailto:info@edcon-components.com)

# EDCON-COMPONENTS

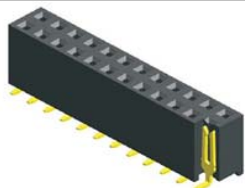

**Contact**



## Ordering Informations

Serie	No. of Pos.	Construction	Contact Plating	Material	Special function	Pin Length Code	ROHS	Packing		
<b>T27A1199-</b>	<b>XX</b>	<b>SS</b>	<b>G0</b>	<b>PB</b>	<b>N</b>	<b>A01</b>	<b>R</b>	<b>TU</b>		

<b>04 ~80Pos.</b>	<b>SS=</b> Straight SMD	<b>G0=</b> Gold Flash (Standard)	<b>PB=</b> P.B.T	<b>N=</b> No function	Look Table No. 1	<b>N=</b> NO ROHS conform	<b>BU=</b> Bulk (Standard)
	<b>T0=</b> Tin plated	<b>NY=</b> Nylon-6T	<b>R=</b> ROHS conform			<b>TU=</b> Tube w/o Cap	
	<b>T0=</b> Tin plated	<b>PA=</b> PA-46				<b>TC=</b> Tube w. pic and Place Cap	
	<b>GA=</b> 3µ Gold Plating			<b>TY=</b> Tray packing w/o Cap			
	<b>GB=</b> 5µ Gold Plating			<b>TR=</b> Tape/Reel w. pic and Place Cap			
	<b>GC=</b> 10µ Gold Plating						
	<b>GD=</b> 15µ Gold Plating						
	<b>GE=</b> 20µ Gold Plating						
	<b>GF=</b> 30µ Gold Plating						
	<b>S0=</b> Selectiv Plating Gold Flash / Tin						

<b>Female Header Pitch 2,54mm</b>	
Part No.:	<b>T27A1199-</b>
Customer:	

DRW:	Jason	CHKD	Wilson	MATL:	Wilson	TOLERANCE	Mason	DATE	11.03.2018
APPD:	Schumi			FINISH	Jamy		Sheet No.		3 from 4

# EDCON-COMPONENTS

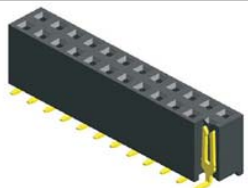

**Contact**



Soldering Profile for Lead Free Soldering ( P.B.T. )

Soldering Profile for Lead Free Soldering ( Nylon 6T )

## Classification Reflow Profile (JEDEC J-STD-020C)

## Classification Reflow Profile (JEDEC J-STD-020C)

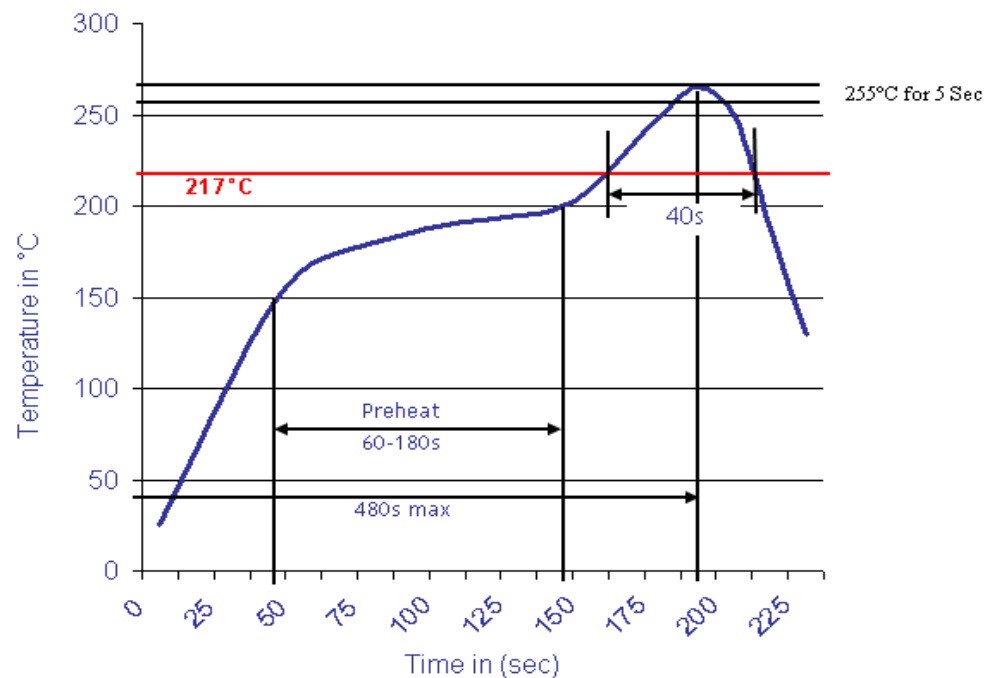
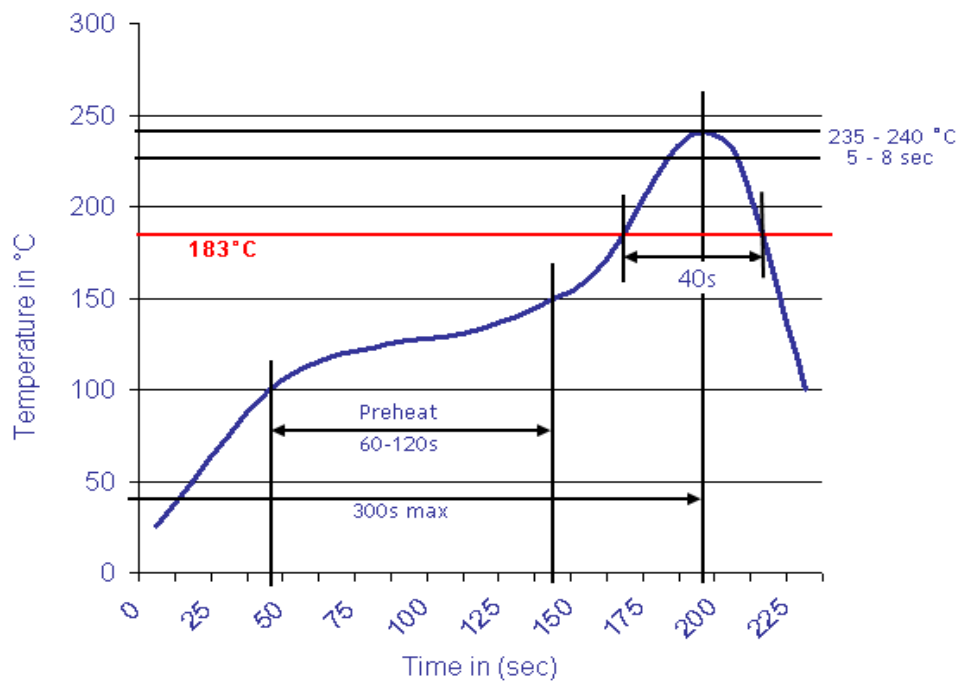

**Female Header Pitch  
2,54mm**

Part No.: **T27A1199-**

DRW:	Jason	CHKD	Wilson	MATL:	Wilson	TOLERANCE	Mason	DATE	11.03.2018
APPD:	Schumi			FINISH	Jamy		Sheet No.		4 from 4

Customer:

[www.edcon-components.com](http://www.edcon-components.com)

email: [info@edcon-components.com](mailto:info@edcon-components.com)