

EDCON-COMPONENTS

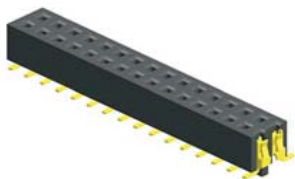

Contact



Specifications

Current Rating:	3 Ampere
Insulator Resistance:	1000 Megaohm min.
Contact Resistance:	20m Ohm max.
Dielectric Withstanding:	AC 500V
Operating Temperature:	.-40°C to +105°C
Contact Material:	Phosphor Bronze
Insulator Material:	Polyester, UL 94V-0
Standard:	PBT
Contact Plating:	Tin, Gold or Selective Plated
Standard:	Gold Flash Overall

PCB Layout

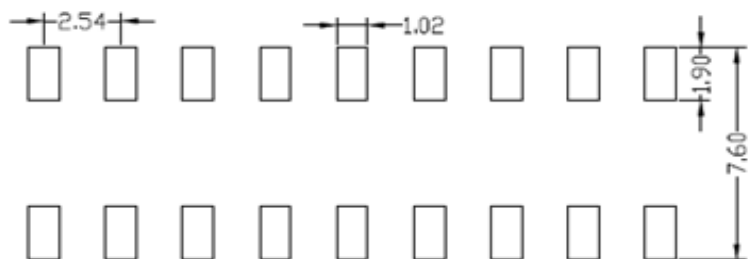

Drawing (mm)

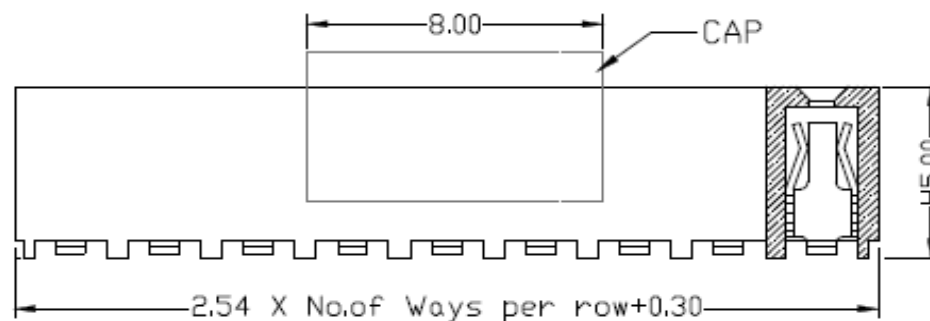
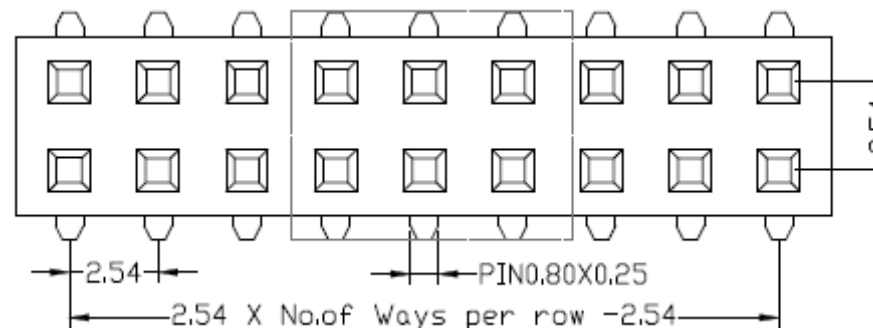

**Female Header Pitch
2,54mm**

DRW:	Jason	CHKD	Wilson	MATL:	X=	X.X=	X.XX=	X.XXX=	Angle	Part No.:	T27A1198-
APPD:	Schumi			FINISH	±0,35	±0,25	±0,20	±0,15	±5°	Customer:	
					Wilson	TOLERANCE	Mason	DATE	11.03.2018	Sheet No.	1 from 4

EDCON-COMPONENTS

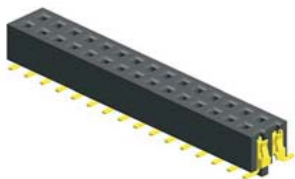

Contact



Pin Code length table 1 free configuration

Drawing (mm)

Order Code	Dimension (mm)			
	D			
A01	6,60			
A02				
A03				
A04				
A05				
A06				
A07				
A08				
A09				
A10				
A11				
A12				
A13				
A14				
A15				
A16				
A17				
A18				
A19				
A20				
A21				
A22				
A23				
A24				
A25				
A26				
A27				

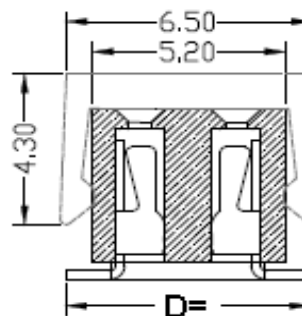

Female Header Pitch 2,54mm	
Part No.:	T27A1198-
Customer:	

DRW:	Jason	CHKD	Wilson	MATL:	Wilson	TOLERANCE	Mason	DATE	11.03.2018
APPD:	Schumi			FINISH	Jamy		Sheet No.		2 from 4

www.edcon-components.com

email: info@edcon-components.com

EDCON-COMPONENTS

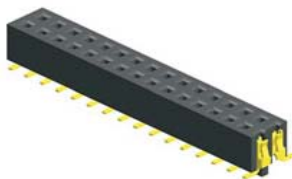

Contact



Ordering Informations

Serie	No. of Pos.	Construction	Contact Plating	Material	Special function	Pin Length Code	ROHS	Packing		
T27A1198-	XX	SS	G0	PB	N	A01	R	TU		

04 ~80Pos.	SS= Straight SMD	G0= Gold Flash (Standard)	PB= P.B.T	N= No function	Look Table No. 1	N= NO ROHS conform	BU= Bulk (Standard)
	T0= Tin plated	NY= Nylon-6T	R= ROHS conform			TU= Tube w/o Cap	
	T0= Tin plated	PA= PA-46				TC= Tube w. pic and Place Cap	
	GA= 3µ Gold Plating			TY= Tray packing w/o Cap			
	GB= 5µ Gold Plating			TR= Tape/Reel w. pic and Place Cap			
	GC= 10µ Gold Plating						
	GD= 15µ Gold Plating						
	GE= 20µ Gold Plating						
	GF= 30µ Gold Plating						
	S0= Selectiv Plating Gold Flash / Tin						

Female Header Pitch 2,54mm	
Part No.:	T27A1198-
Customer:	

DRW:	Jason	CHKD	Wilson	MATL:	Wilson	TOLERANCE	Mason	DATE	11.03.2018
APPD:	Schumi			FINISH	Jamy		Sheet No.		3 from 4

EDCON-COMPONENTS

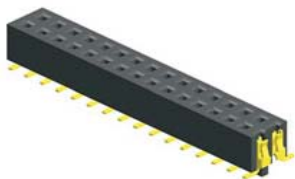

Contact



Soldering Profile for Lead Free Soldering (P.B.T.)

Soldering Profile for Lead Free Soldering (Nylon 6T)

Classification Reflow Profile (JEDEC J-STD-020C)

Classification Reflow Profile (JEDEC J-STD-020C)

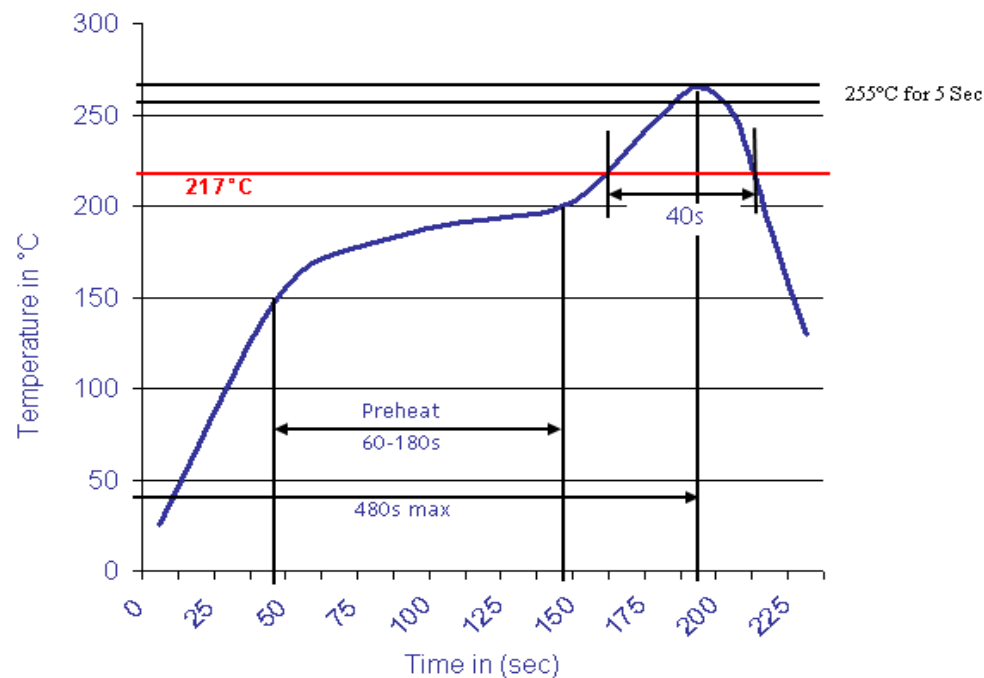
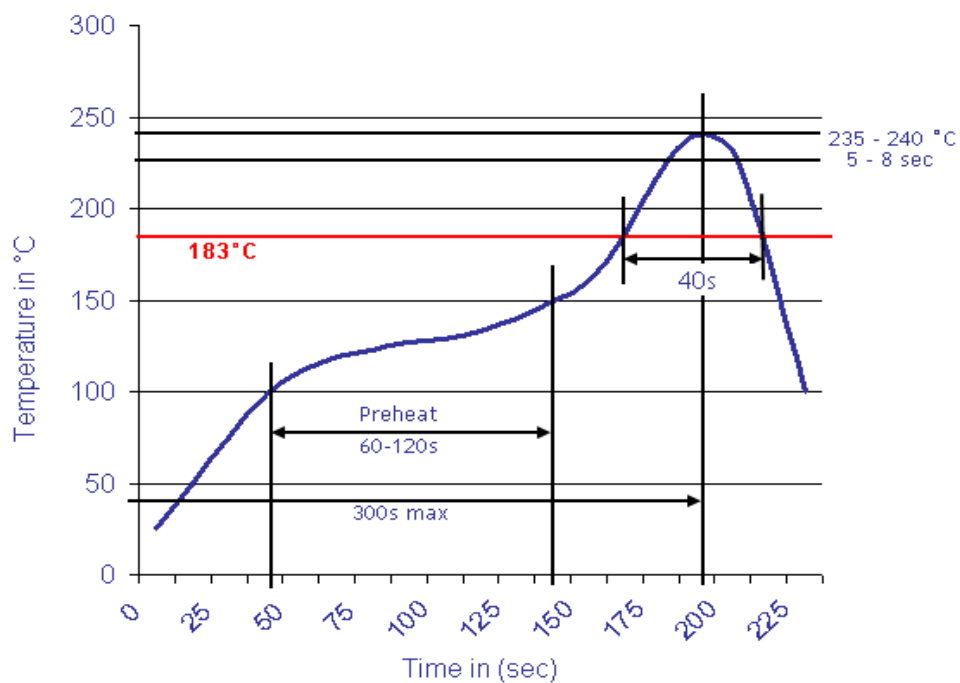

**Female Header Pitch
2,54mm**

Part No.: **T27A1198-**

DRW:	Jason	CHKD	Wilson	MATL:	Wilson	TOLERANCE	Mason	DATE	11.03.2018	Customer:
APPD:	Schumi			FINISH	Jamy		Sheet No.	4 from 4		

www.edcon-components.com

email: info@edcon-components.com