

# EDCON-COMPONENTS

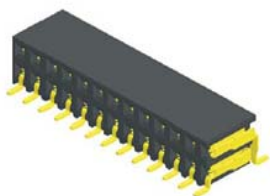

## Specifications

Current Rating:	3,0 Ampere
Insulator Resistance:	5000 Megaohm min.
Contact Resistance	20m Ohm max.
Dielectric Withstanding:	AC 500V
Operating Temperature:	.-65°C to +125°C
Contact Material:	Brass
Insulator Material:	PBT, UL94V0
Contact Plating:	Tin, Gold or Selective Plated
Standard:	Gold Flash Overall

## PCB Layout

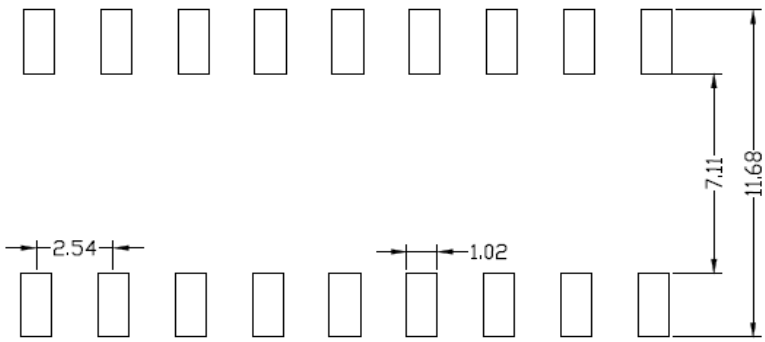

## Technical Drawing

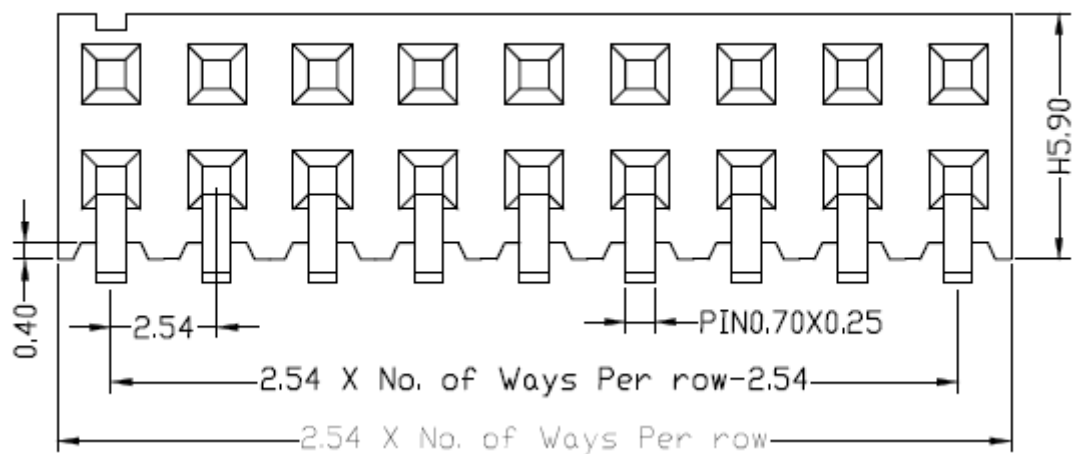

<b>SMD Dual Row Female Header Pitch 2,54mm</b>	
Part No.:	<b>T27A1179-</b>
Customer:	

DRW:	Jason	CHKD	Wilson	MATL:	Wilson	TOLERANCE	Mason	DATE	01.10.2017
APPD:	Schumi			FINISH	Jamy		Sheet No.		1 from 4

# EDCON-COMPONENTS

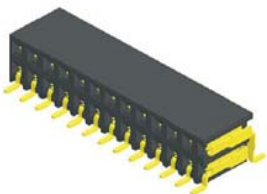

**Contact**



## Technical Drawing

Table No.1	Dimension (mm)		
	A	B	C
Order Code	11,18		
A01			
A02			
A03			
A04			
A05			
A06			
A07			
A08			
A09			
A10			
A11			
A12			
A13			
A14			
A15			
A16			
A17			
A18			
A19			
A20			
A21			
A22			

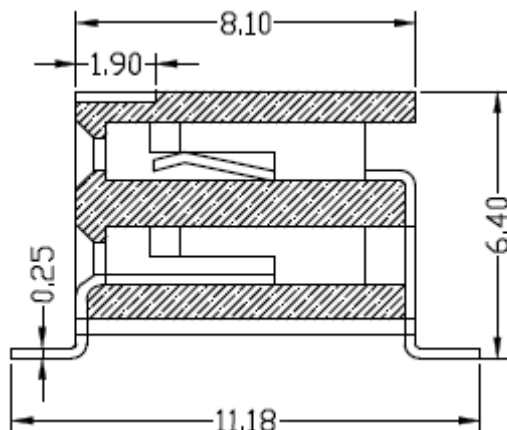

**SMD Dual Row Female Header Pitch 2,54mm**

Part No.: **T27A1179-**

DRW:	Jason	CHKD	Wilson	MATL:	Wilson	TOLERANCE	Mason	DATE	01.10.2017
APPD:	Schumi			FINISH	Jamy		Sheet No.	2 from 4	

Customer:

# EDCON-COMPONENTS

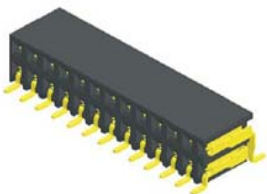

**Contact**



## Ordering Informations

Serie	No. of Pos.	Construction	Contact Plating	Material	Special function	Pin Length Code	ROHS	Packing		
<b>T27A1179-</b>	<b>XX</b>	<b>RS</b>	<b>G0</b>	<b>PB</b>	<b>N</b>	<b>A01</b>	<b>R</b>	<b>TU</b>		

<b>04 ~ 80Pos.</b>	<b>RS=</b> Right Angle SMD	<b>G0=</b> Gold Flash (Standard)	<b>PB=</b> PBT	<b>N=</b> No special function	look Table No. 1	<b>N=</b> NO ROHS conform	<b>BU=</b> Bulk (Standard)
		<b>T0=</b> Tin plated	<b>P6=</b> PA 6T			<b>R=</b> ROHS conform	<b>TU=</b> Tube w/o Cap
		<b>GA=</b> 3µ Gold Plating	<b>LC=</b> LCP				<b>TC=</b> Tube w. pic and Place Cap
		<b>GB=</b> 5µ Gold Plating	<b>PA=</b> PA-46				<b>TY=</b> Tray packing w/o Cap
		<b>GC=</b> 10µ Gold Plating	<b>P9=</b> PA 9T				<b>TR=</b> Tape/Reel w. pic and Place Cap
		<b>GC=</b> 15µ Gold Plating					
		<b>GC=</b> 30µ Gold Plating					

**SMD Dual Row Female Header Pitch 2,54mm**

Part No.: **T27A1179-**

DRW:	Jason	CHKD	Wilson	MATL:	Wilson	TOLERANCE	Mason	DATE	01.10.2017
APPD:	Schumi			FINISH	Jamy		Sheet No.		3 from 4

Customer:

# EDCON-COMPONENTS

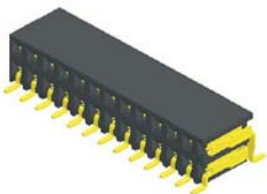

**Contact**



## Soldering Profile for Lead Soldering ( P.B.T. )

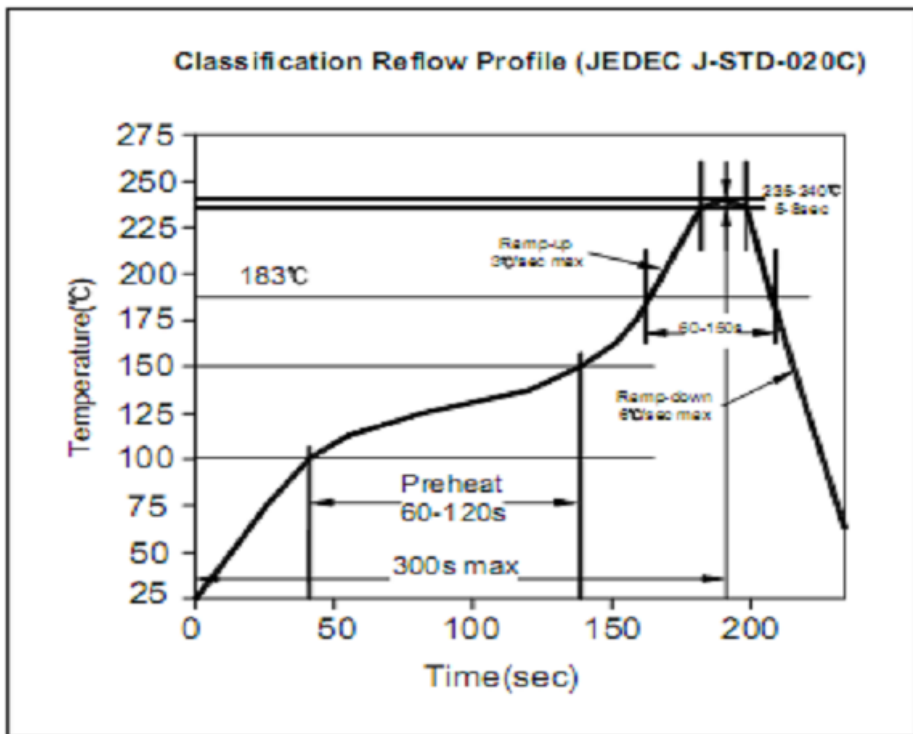

## Soldering Profile for Lead Free Soldering ( PA6T )

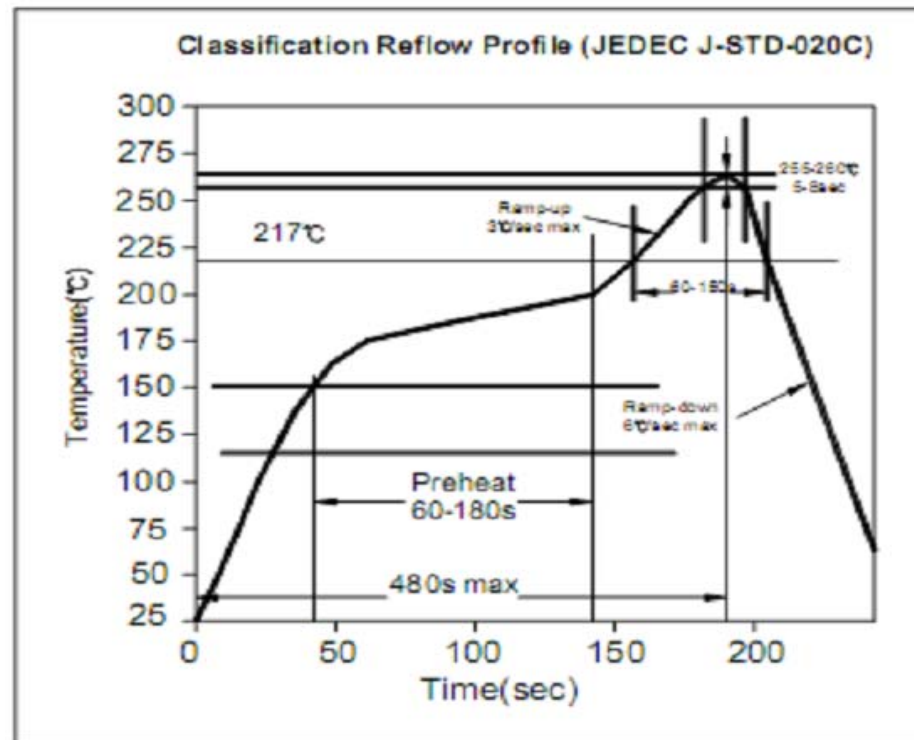

**SMD Dual Row Female Header Pitch 2,54mm**

Part No.: **T27A1179-**

DRW:	Jason	CHKD	Wilson	MATL:	Wilson	TOLERANCE	Mason	DATE	01.10.2017
APPD:	Schumi			FINISH	Jamy		Sheet No.	4 from 4	Customer:

[www.edcon-components.com](http://www.edcon-components.com)

email: [info@edcon-components.com](mailto:info@edcon-components.com)