

EDCON-COMPONENTS

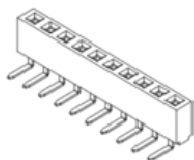

Contact



Specifications

Current Rating:	3,0 Ampere
Insulator Resistance:	5000 Megaohm min.
Contact Resistance	20m Ohm max.
Dielectric Withstanding:	AC 500V
Operating Temperature:	.-65°C to +125°C
Contact Material:	Brass
Insulator Material:	PBT, UL94V0
Contact Plating:	Tin, Gold or Selective Plated
Standard:	Gold Flash Overall

Technical Drawing

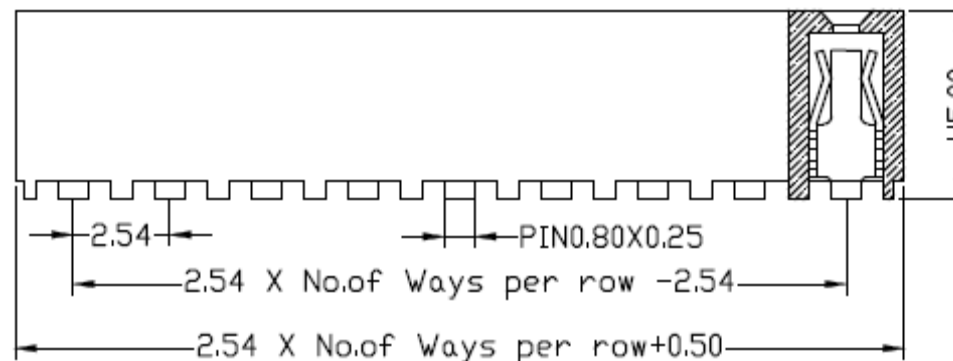

PCB Layout

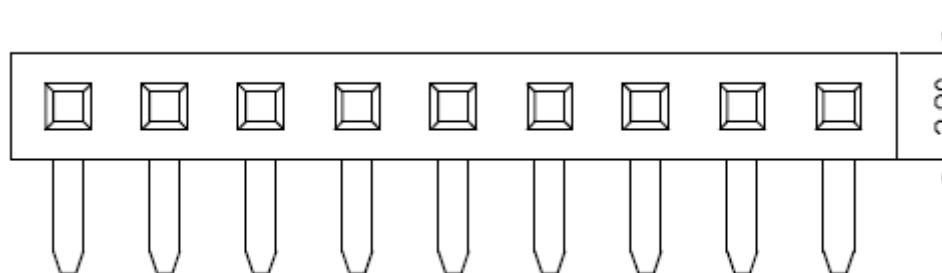

THT Single Row Female Header Pitch 2,54mm

Part No.: **T27A1173-**

DRW:	Jason	CHKD	Wilson	MATL:	Wilson	TOLERANCE	Mason	DATE	01.10.2017
APPD:	Schumi			FINISH	Jamy		Sheet No.	1 from 4	Customer:

www.edcon-components.com

email: info@edcon-components.com

EDCON-COMPONENTS

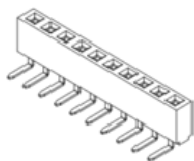

Contact



Technical Drawing

Table No.1			
Order Code	Dimension (mm)		
	A	B	C
A01	3,00		
A02			
A03			
A04			
A05			
A06			
A07			
A08			
A09			
A10			
A11			
A12			
A13			
A14			
A15			
A16			
A17			
A18			
A19			
A20			
A21			
A22			

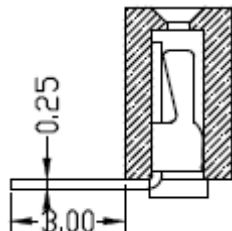

THT Single Row Female Header Pitch 2,54mm	
Part No.:	T27A1173-
Customer:	

DRW:	Jason	CHKD	Wilson	MATL:	Wilson	TOLERANCE	Mason	DATE	01.10.2017
APPD:	Schumi			FINISH	Jamy		Sheet No.	2 from 4	

EDCON-COMPONENTS

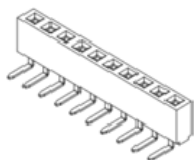

Contact



Ordering Informations

Serie	No. of Pos.	Construction	Contact Plating	Material	Special function	Pin Length Code	ROHS	Packing		
T27A1173-	XX	RT	G0	PB	N	A01	R	BU		

02 ~ 40Pos.	RT= Right Angle THT	G0= Gold Flash (Standard)	PB= PBT	N= No special function	look Table No. 1	N= NO ROHS conform	BU= Bulk (Standard)
		T0= Tin plated	P6= PA 6T			R= ROHS conform	TU= Tube w/o Cap
		GA= 3µ Gold Plating	LC= LCP				TC= Tube w. pic and Place Cap
		GB= 5µ Gold Plating	PA= PA-46				TY= Tray packing w/o Cap
		GC= 10µ Gold Plating	P9= PA 9T				TR= Tape/Reel w. pic and Place Cap
		GC= 15µ Gold Plating					
		GC= 30µ Gold Plating					

THT Single Row Female Header Pitch 2,54mm

Part No.: **T27A1173-**

DRW:	Jason	CHKD	Wilson	MATL:	Wilson	TOLERANCE	Mason	DATE	01.10.2017
APPD:	Schumi			FINISH	Jamy		Sheet No.		3 from 4

Customer:

EDCON-COMPONENTS

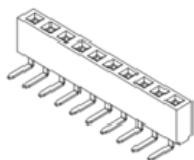

Contact



Soldering Profile for Lead Soldering (P.B.T.)

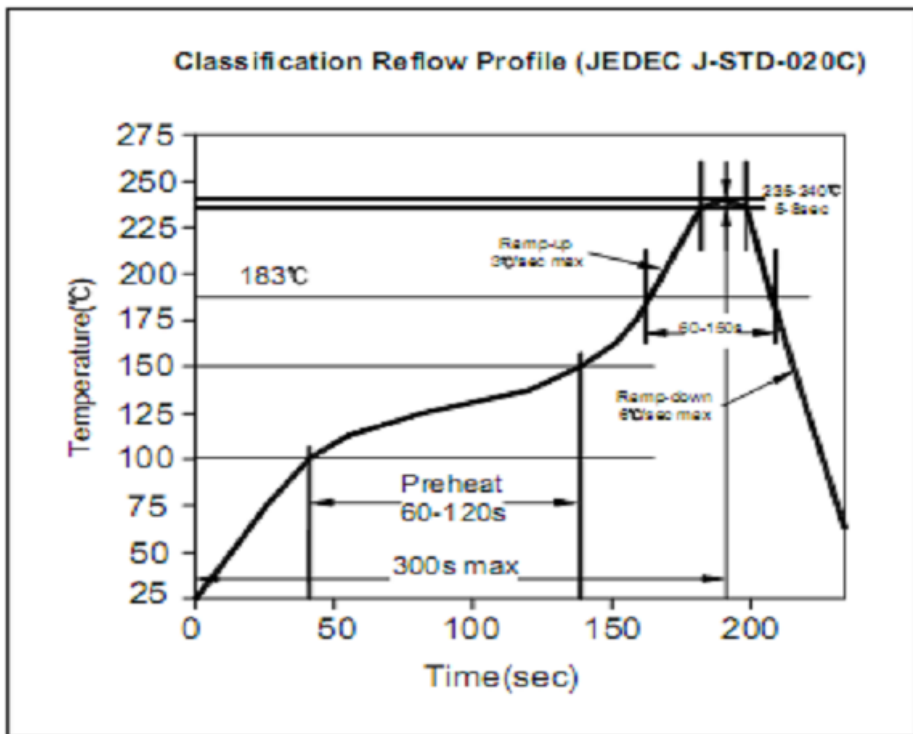

Soldering Profile for Lead Free Soldering (PA6T)

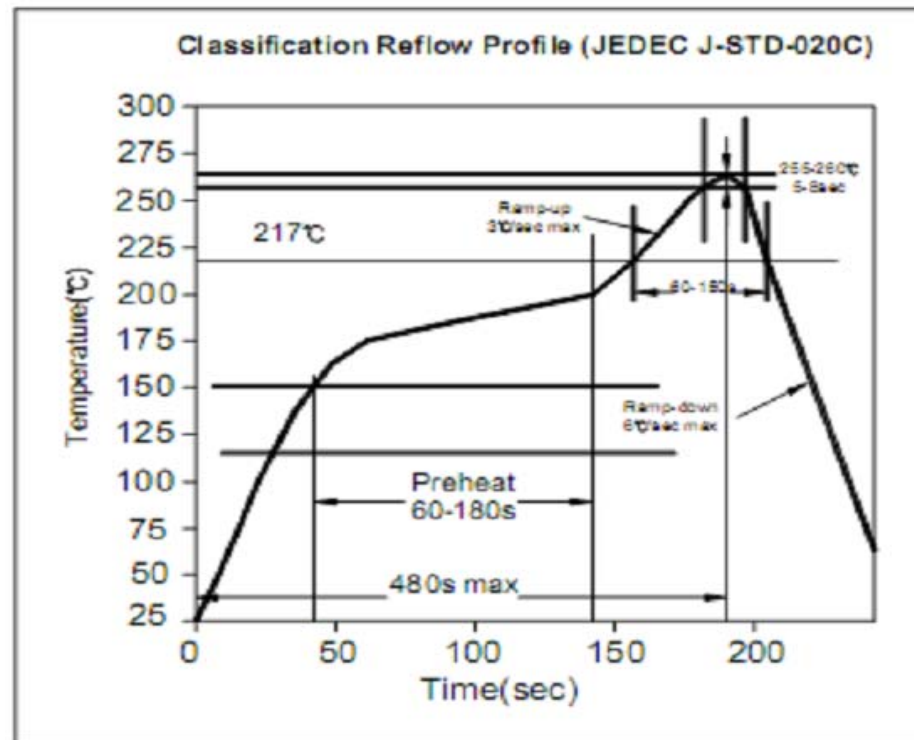

THT Single Row Female Header Pitch 2,54mm

Part No.: **T27A1173-**

DRW:	Jason	CHKD	Wilson	MATL:	Wilson	TOLERANCE	Mason	DATE	01.10.2017
APPD:	Schumi			FINISH	Jamy		Sheet No.	4 from 4	Customer:

www.edcon-components.com

email: info@edcon-components.com