

EDCON-COMPONENTS

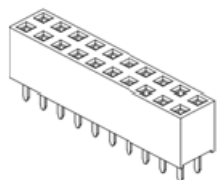

Contact



Specifications

Current Rating:	3,0 Ampere
Insulator Resistance:	5000 Megaohm min.
Contact Resistance	20m Ohm max.
Dielectric Withstanding:	AC 500V
Operating Temperature:	.-65°C to +125°C
Contact Material:	Brass
Insulator Material:	PBT, UL94V0
Contact Plating:	Tin, Gold or Selective Plated
Standard:	Gold Flash Overall

Technical Drawing

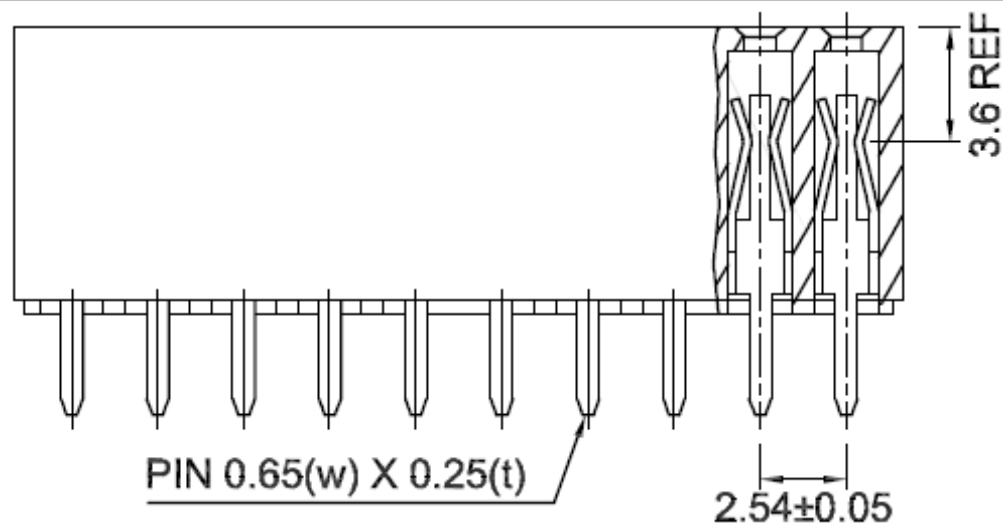

PCB Layout

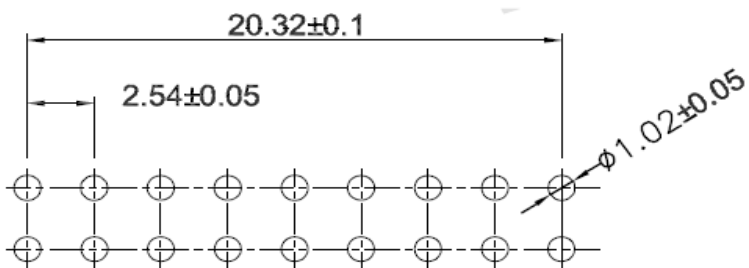

THT Dual Row Female Header Pitch 2,54mm

Part No.: **T27A1131-**

Customer:

DRW:	Jason	CHKD	Wilson	MATL:	Wilson	TOLERANCE	Mason	DATE	01.10.2017
APPD:	Schumi			FINISH	Jamy		Sheet No.	1 from 4	

EDCON-COMPONENTS

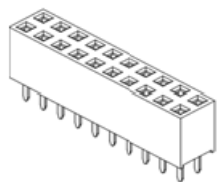

Contact



Technical Drawing

Table No.1	Order Code	Dimension (mm)		
		A		
	A01	3,00		
	A02			
	A03			
	A04			
	A05			
	A06			
	A07			
	A08			
	A09			
	A10			
	A11			
	A12			
	A13			
	A14			
	A15			
	A16			
	A17			
	A18			
	A19			
	A20			
	A21			
	A22			

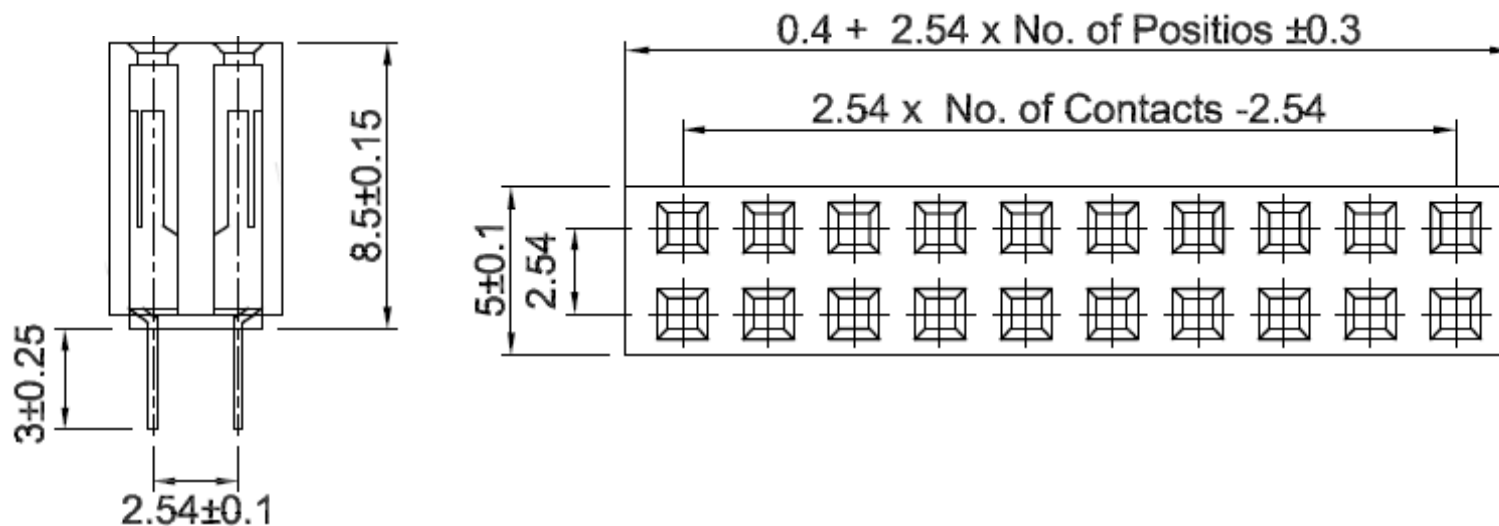

THT Dual Row Female Header Pitch 2,54mm

Part No.: **T27A1131-**

DRW:	Jason	CHKD	Wilson	MATL:	Wilson	TOLERANCE	Mason	DATE	01.10.2017
APPD:	Schumi			FINISH	Jamy		Sheet No.	2 from 4	

Customer:

EDCON-COMPONENTS

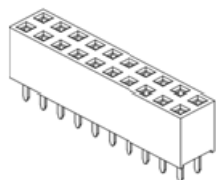

Contact



Ordering Informations

Serie	No. of Pos.	Construction	Contact Plating	Material	Special function	Pin Length Code	ROHS	Packing		
T27A1131-	XX	ST	G0	PB	N	A01	R	BU		

04 ~ 80Pos.	SS= Straight THT	G0= Gold Flash (Standard)	PB= PBT	N= No Special	look Table No. 1	N= NO ROHS conform	BU= Bulk (Standard)
		T0= Tin plated	P6= PA 6T			R= ROHS conform	TU= Tube w/o Cap
		GA= 3µ Gold Plating	LC= LCP				TC= Tube w. pic and Place Cap
		GB= 5µ Gold Plating	PA= PA-46				TY= Tray packing w/o Cap
		GC= 10µ Gold Plating	P9= PA 9T				TR= Tape/Reel w. pic and Place Cap
		GC= 15µ Gold Plating					
		GC= 30µ Gold Plating					

THT Dual Row Female Header Pitch 2,54mm	
Part No.:	T27A1131-
Customer:	

DRW:	Jason	CHKD	Wilson	MATL:	Wilson	TOLERANCE	Mason	DATE	01.10.2017
APPD:	Schumi			FINISH	Jamy		Sheet No.		3 from 4

EDCON-COMPONENTS

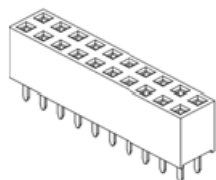

Contact



Soldering Profile for Lead Soldering (P.B.T.)

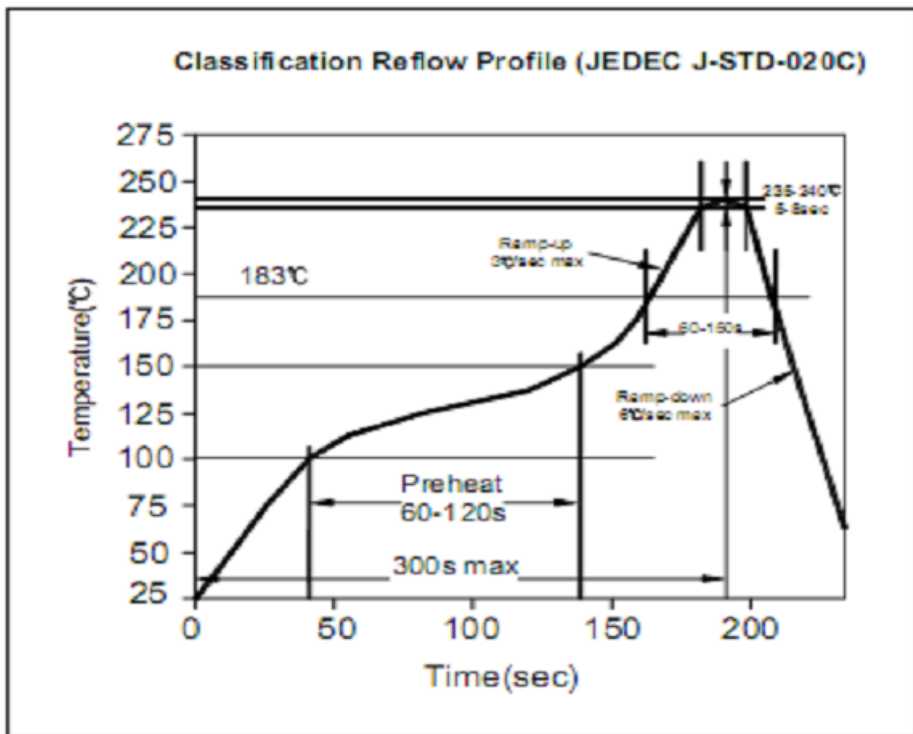

Soldering Profile for Lead Free Soldering (PA6T)

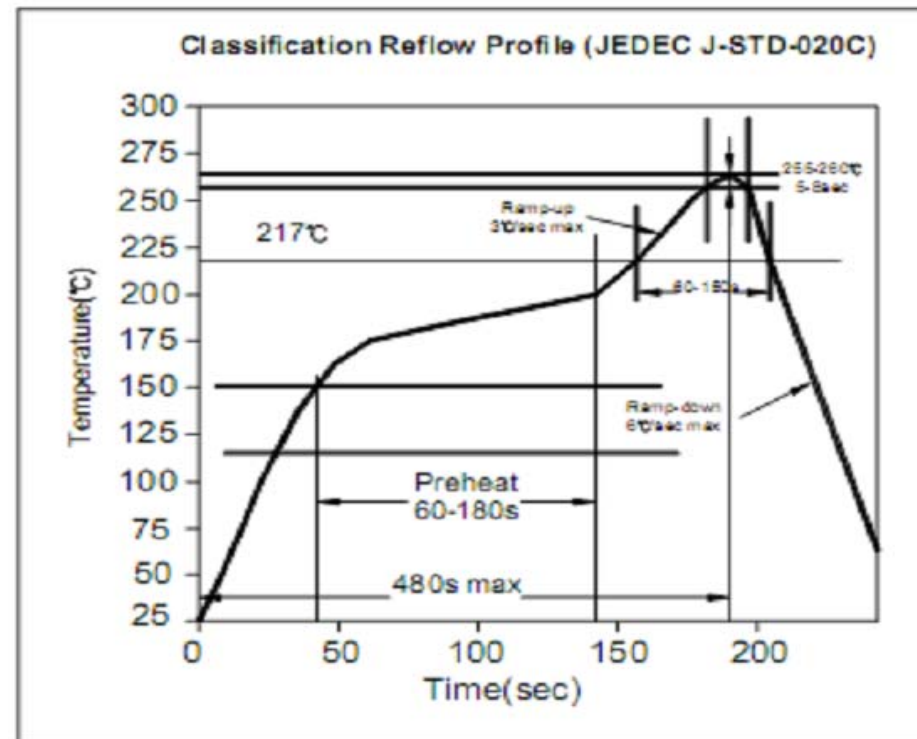

THT Dual Row Female Header Pitch 2,54mm

Part No.: **T27A1131-**

DRW:	Jason	CHKD	Wilson	MATL:	Wilson	TOLERANCE	Mason	DATE	01.10.2017
APPD:	Schumi			FINISH	Jamy		Sheet No.	4 from 4	Customer:

www.edcon-components.com

email: info@edcon-components.com