

# EDCON-COMPONENTS

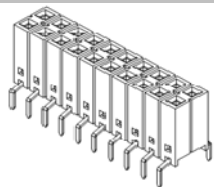

**Contact**



## Specifications

Current Rating:	3 Ampere
Insulator Resistance:	1000 Megaohm min.
Contact Resistance	20m Ohm max.
Dielectric Withstanding:	AC 500V
Operating Temperature:	.-40°C to +105°C
Contact Material:	Phosphor Bronze
Insulator Material:	Polyester, UL 94V-0
Standard:	PBT
Contact Plating:	Tin, Gold or Selective Plated
Standard:	Gold Flash Overall

## PCB Layout

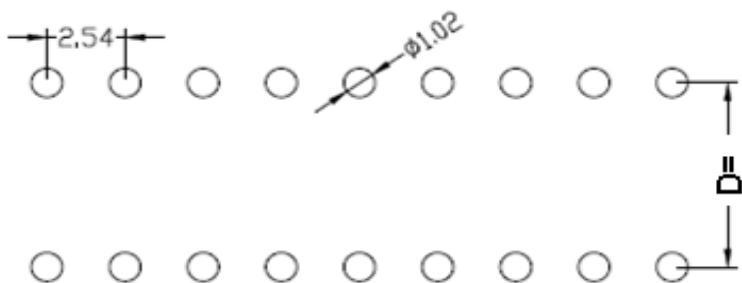

## Drawing (mm)

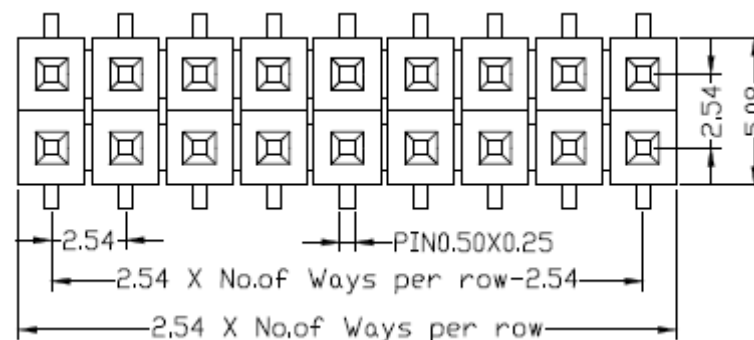
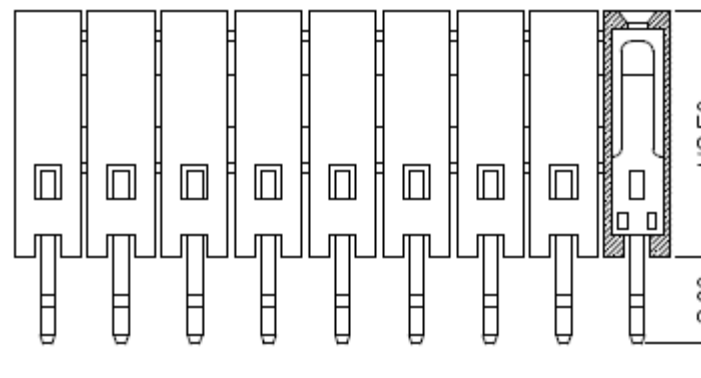

**Female Header Pitch  
2,54mm**

DRW:	Jason	CHKD	Wilson	MATL:	X=	X.X=	X.XX=	X.XXX=	Angle
APPD:	Schumi			FINISH	±0,35	±0,25	±0,20	±0,15	±5°
					Wilson	TOLERANCE	Mason	DATE	11.03.2018
					Jamy		Sheet No.		1 from 4

Part No.:	<b>T27A1112-</b>
Customer:	

# EDCON-COMPONENTS

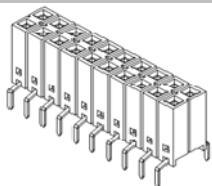

**Contact**



Pin Code length table 1 free configuration

Drawing (mm)

Order Code	Dimension (mm)		
	D		
A01	6,50		
A02			
A03			
A04			
A05			
A06			
A07			
A08			
A09			
A10			
A11			
A12			
A13			
A14			
A15			
A16			
A17			
A18			
A19			
A20			
A21			
A22			
A23			
A24			
A25			
A26			
A27			

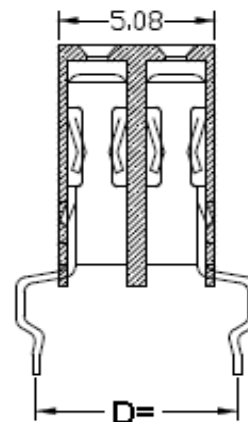

<b>Female Header Pitch 2,54mm</b>	
Part No.:	<b>T27A1112-</b>
Customer:	

DRW:	Jason	CHKD	Wilson	MATL:	Wilson	TOLERANCE	Mason	DATE	11.03.2018
APPD:	Schumi			FINISH	Jamy		Sheet No.		2 from 4

[www.edcon-components.com](http://www.edcon-components.com)

email: [info@edcon-components.com](mailto:info@edcon-components.com)

# EDCON-COMPONENTS

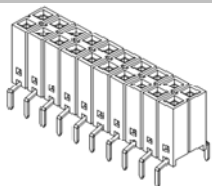

**Contact**



## Ordering Informations

Serie	No. of Pos.	Construction	Contact Plating	Material	Special function	Pin Length Code	ROHS	Packing		
<b>T27A1112-</b>	<b>XX</b>	<b>ST</b>	<b>G0</b>	<b>PB</b>	<b>N</b>	<b>A01</b>	<b>R</b>	<b>TU</b>		

<b>04 ~80Pos.</b>	<b>ST= Straight THT</b>	<b>G0= Gold Flash (Standard)</b>	<b>PB= P.B.T</b>	<b>N= No function</b>	Look Table No. 1	<b>N=NO ROHS conform</b>	<b>BU= Bulk (Standard)</b>
		<b>T0= Tin plated</b>	<b>NY= Nylon-6T</b>			<b>R= ROHS conform</b>	<b>TU= Tube w/o Cap</b>
	<b>T0= Tin plated</b>	<b>PA= PA-46</b>		<b>TC= Tube w. pic and Place Cap</b>			
	<b>GA= 3µ Gold Plating</b>			<b>TY= Tray packing w/o Cap</b>			
	<b>GB= 5µ Gold Plating</b>			<b>TR= Tape/Reel w. pic and Place Cap</b>			
	<b>GC= 10µ Gold Plating</b>						
	<b>GD= 15µ Gold Plating</b>						
	<b>GE= 20µ Gold Plating</b>						
	<b>GF= 30µ Gold Plating</b>						
	<b>S0= Selectiv Plating Gold Flash / Tin</b>						

<b>Female Header Pitch 2,54mm</b>	
Part No.:	<b>T27A1112-</b>
Customer:	

DRW:	Jason	CHKD	Wilson	MATL:	Wilson	TOLERANCE	Mason	DATE	11.03.2018
APPD:	Schumi			FINISH	Jamy		Sheet No.		3 from 4

# EDCON-COMPONENTS

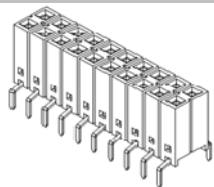

**Contact**



Soldering Profile for Lead Free Soldering ( P.B.T. )

Soldering Profile for Lead Free Soldering ( Nylon 6T )

## Classification Reflow Profile (JEDEC J-STD-020C)

## Classification Reflow Profile (JEDEC J-STD-020C)

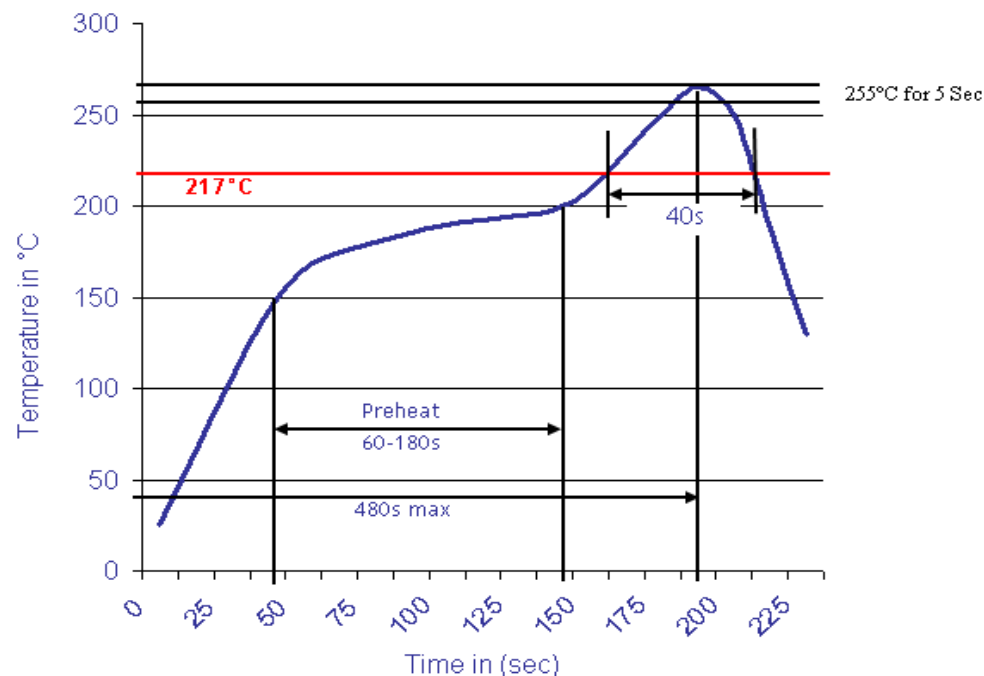
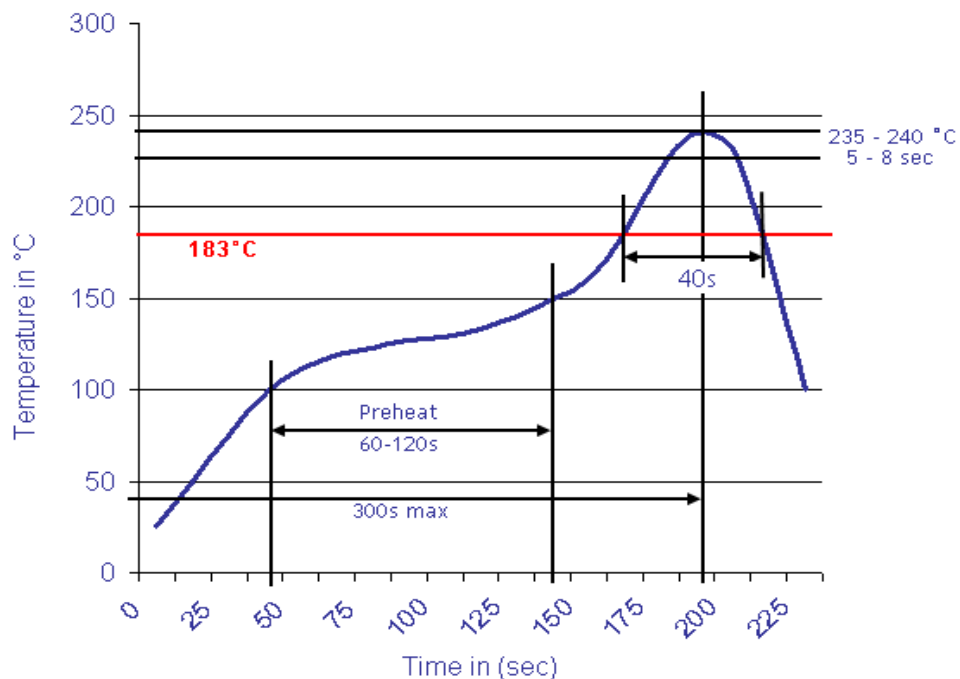

**Female Header Pitch  
2,54mm**

Part No.: **T27A1112-**

DRW:	Jason	CHKD	Wilson	MATL:	Wilson	TOLERANCE	Mason	DATE	11.03.2018	Customer:
APPD:	Schumi			FINISH	Jamy		Sheet No.	4 from 4		

[www.edcon-components.com](http://www.edcon-components.com)

email: [info@edcon-components.com](mailto:info@edcon-components.com)