

EDCON-COMPONENTS



Specifications

Current Rating:	2,0A
Operating Temperature:	-55°C ~ +105°C
Contact Resistance:	20 M Ω max.
Withstanding Voltage:	AC 1000V for 1 Minute
Insulation Resistance:	100000M Ω min at DC100V
Contact Material:	Phosphor Bronze
Contact Plating:	Au or Sn over Ni
Insulator Material:	PBT +30%GF UL 94V-0
Insertion Force:	48Pin max. 45N
Withdrawal Force:	0,24N min per individ. Contact

Drawing (dimensions all into mm)

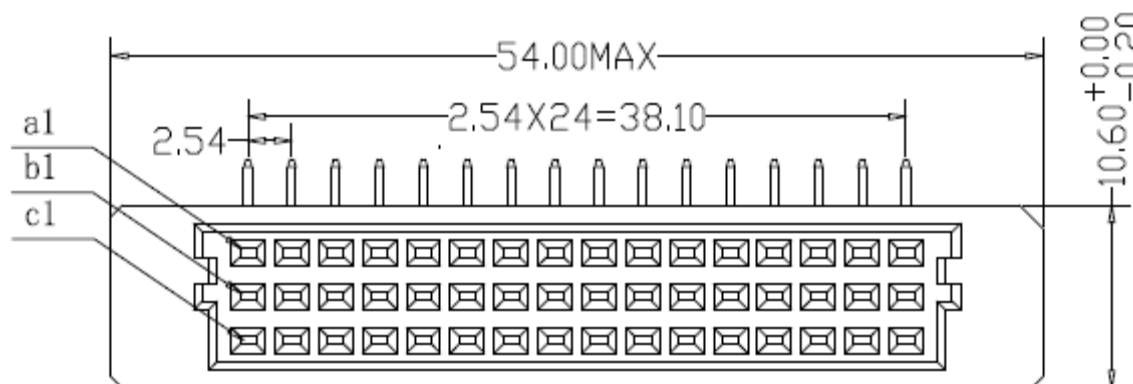

PCB Layout

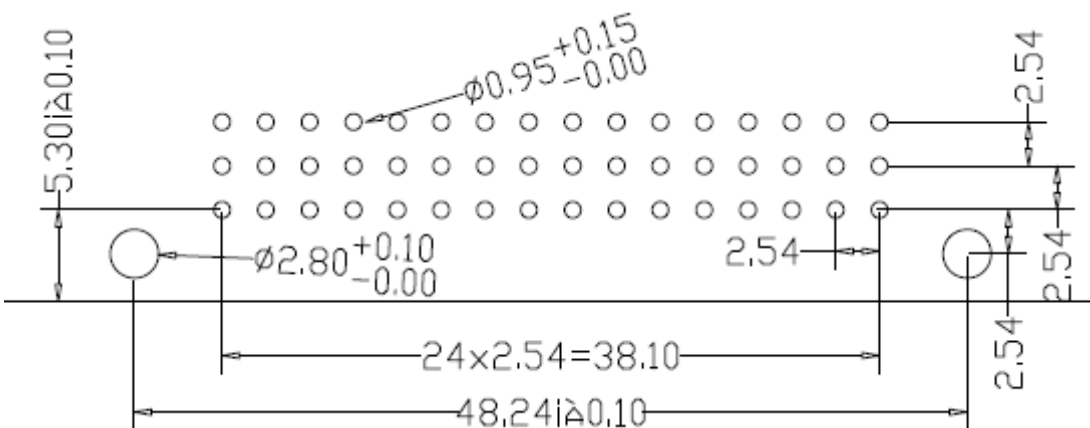

**DIN41612 Connector 1/2 Size
Type R Female R/A**

Part No.: **T21066-**

DRW:	Jason	CHKD	Wilson	MATL:	Wilson	TOLERANCE	Mason	DATE	18.02.2017	Customer:
APPD:	Schumi			FINISH	Jamy		Sheet No.	1 from 4		

EDCON-COMPONENTS

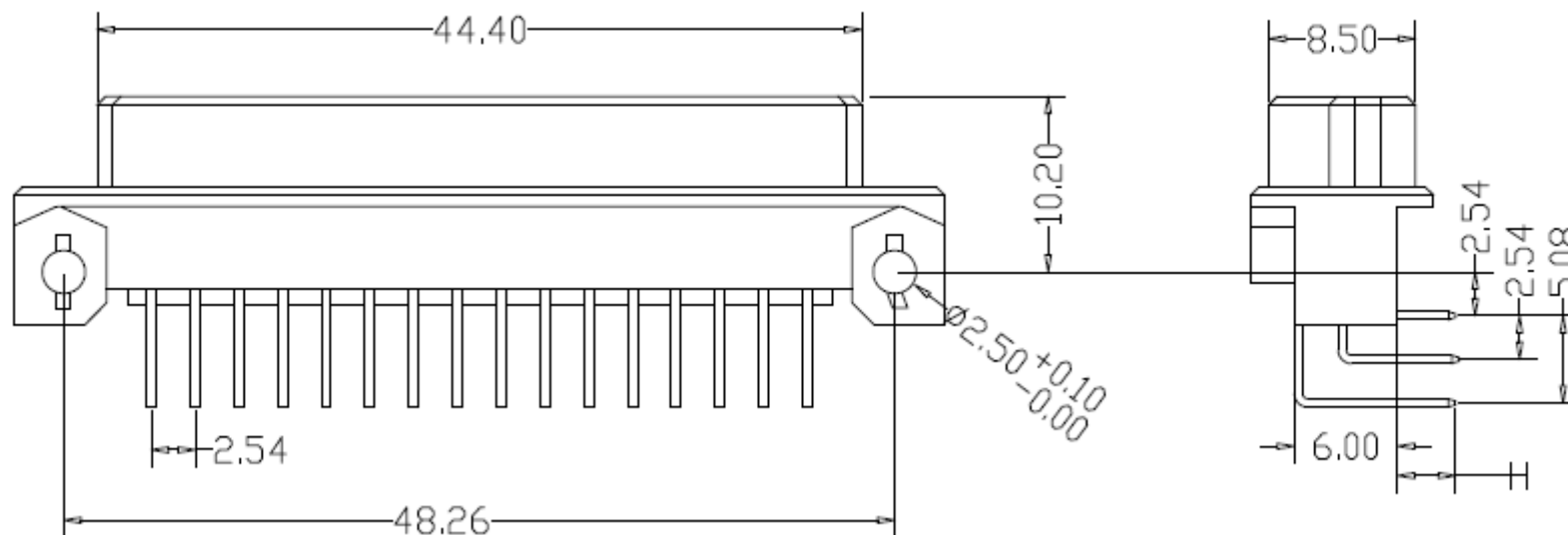
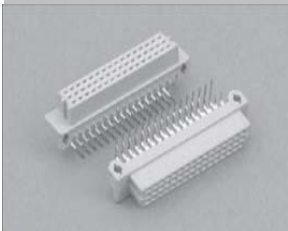

**DIN41612 Connector 1/2 Size
Type R Female R/A**

Part No.: **T21066-**

Customer:

DRW:	Jason	CHKD	Wilson	MATL:	Wilson	TOLERANCE	Mason	DATE	18.02.2017
APPD:	Schumi			FINISH	Jamy		Sheet No.	2 from 4	

EDCON-COMPONENTS

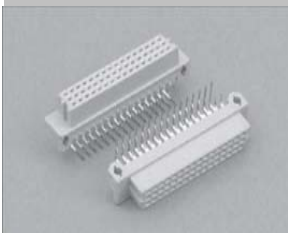

Ordering Informations

Serie	Loaded Contacts	Termination Specification	Row Loaded Contacts	Contact Plating	Special function	Special function	ROHS	Packing		
T21066-	16	A1	K0	S0	N	N	R	TY		

16 = Pos.	A1=Solder H=3,0mm	A0= Only Row A 2,4,6.	G0= Gold Flash	N= No Special	N= No Special	R= ROHS Conform	BU= Bulk Packing		
24 = Pos.		B0= Row A + B	S0= Selectiv Gold Flash/Ni			N= NON ROHS	TY= Tray Packing		
32 = Pos.		C0= Row A + C	G1= 3µ AU Gold				IV= Individual Packing		
48 = Pos.	A4=Tail H=7,0mm	F0= Row A + B + C	G2= 5µ AU Gold						
		C2= Row A+C 2,4,6...	G3= 10µ AU Gold						
		F2= Row A+B+C 2,4,6	G4= 15µ AU Gold						
		C1= Row A+C 1,3,5...	G5= 30µ AU Gold						
		F1= Row A+B+C 1,3,5.	S1= 3µ AU Gold / Ni	S4= 15µ AU Gold / Ni					
			S2= 5µ AU Gold / Ni	S5= 30µ AU Gold / Ni					
			S3= 10µ AU Gold / Ni	TN= Tin Plated					

**DIN41612 Connector 1/2 Size
Type R Female R/A**

Part No.: **T21066-**

Unless Otherwise specified tolerance					
X=± 0,35	X.X=± 0,25	X.XX=± 0,20	X.XXX=± 0,15		
DRW: Jason	CHKD: Wilson	MATL: Wilson	TOLERANCE: Mason	DATE: 18.02.2017	
APPD: Schumi	FINISH: Jamy		Sheet No.:	3 from 4	

Customer:
email: info@edcon-components.com

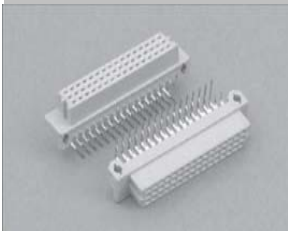

Soldering Informations

Classification Reflow Profile (JEDEC J-STD-020C)

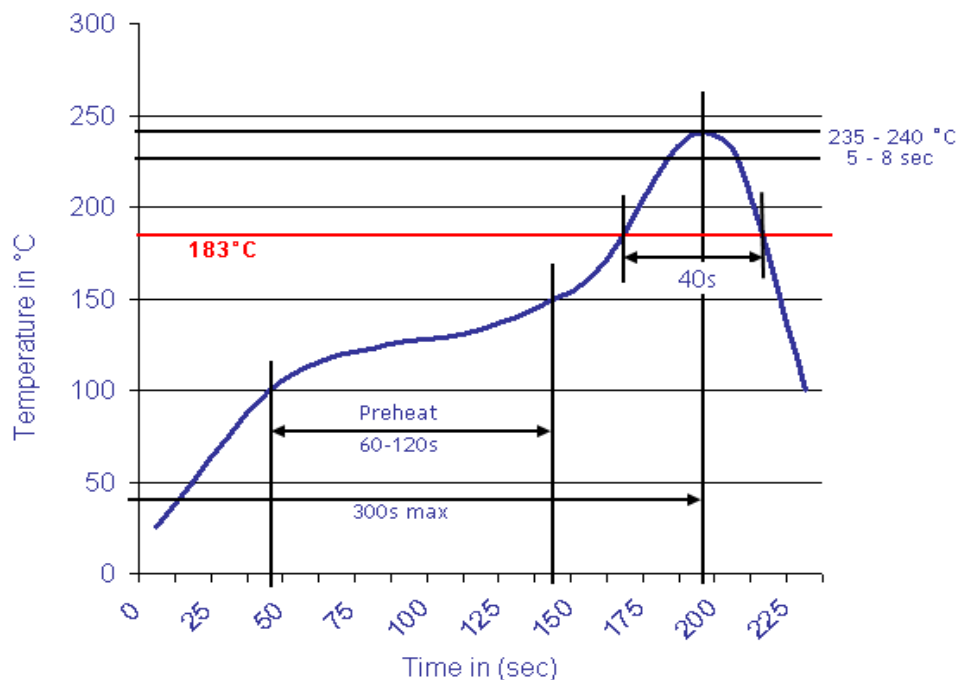

Classification Reflow Profile (JEDEC J-STD-020C)

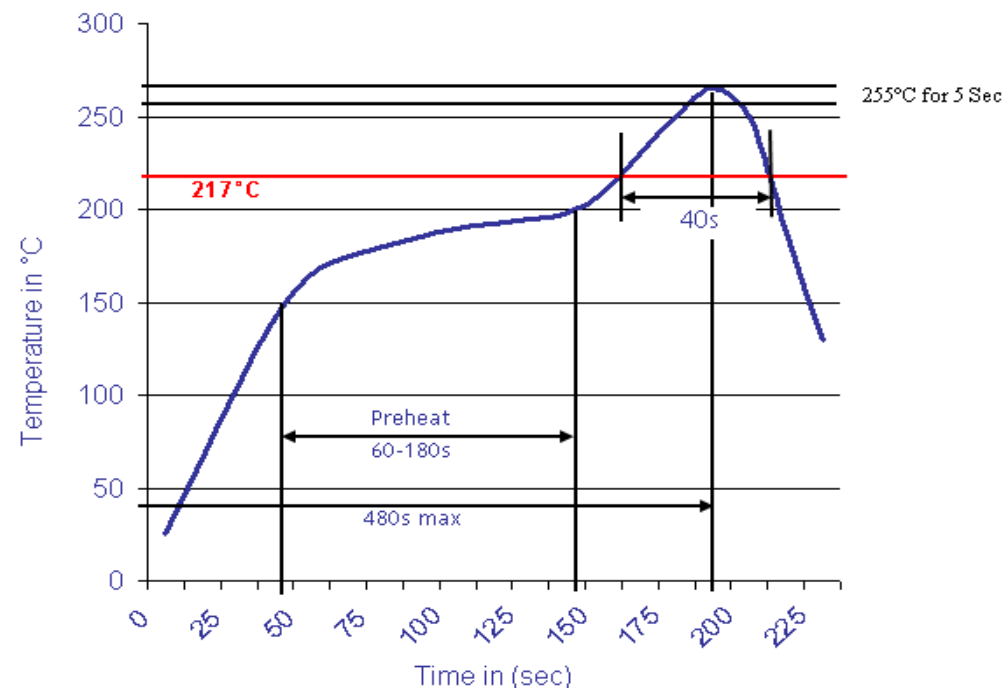

DIN41612 Connector 1/2 Size
Type R Female R/A

Part No.: **T21066-**

DRW:	Jason	CHKD	Wilson	MATL:	Wilson	TOLERANCE	Mason	DATE	18.02.2017
APPD:	Schumi			FINISH	Jamy		Sheet No.	4 from 4	Customer: