

EDCON-COMPONENTS

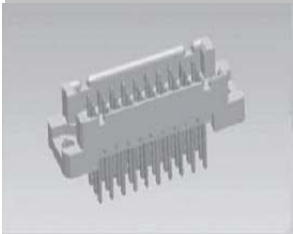

Specifications

Current Rating: 2,0A
Operating Temperature: -55°C ~ +105°C
Contact Resistance: 20 M Ω max.
Withstanding Voltage: AC 1000V for 1 Minute
Insulation Resistance: 100000M Ω min at DC100V

Contact Material: Phosphor Bronze
Contact Plating: Au or Sn over Ni
Insulator Material: PBT +30%GF UL 94V-0
Insertion Force: 30Pin max. 28N
Withdrawal Force: 0,15N min per individ. Contact

Drawing (dimensions all into mm)

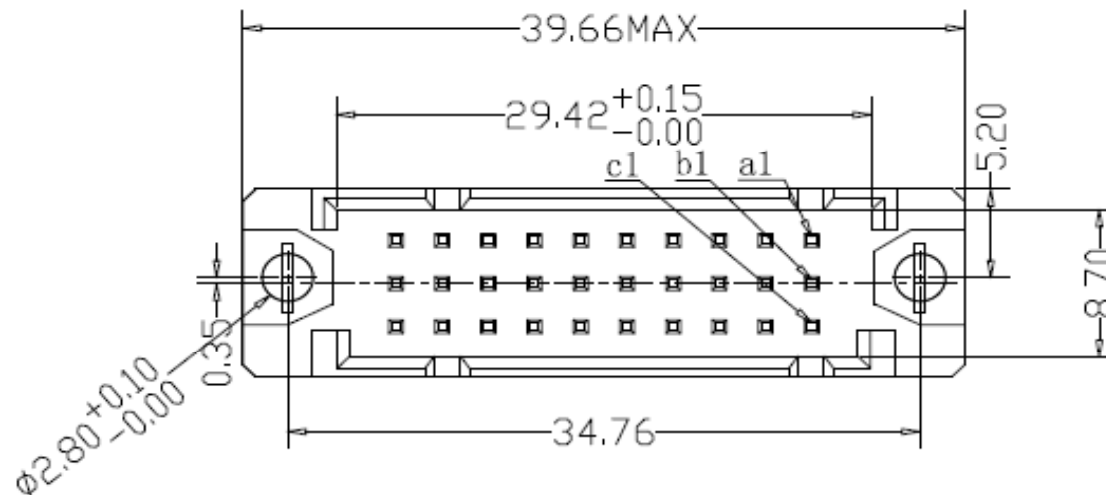

PCB Layout

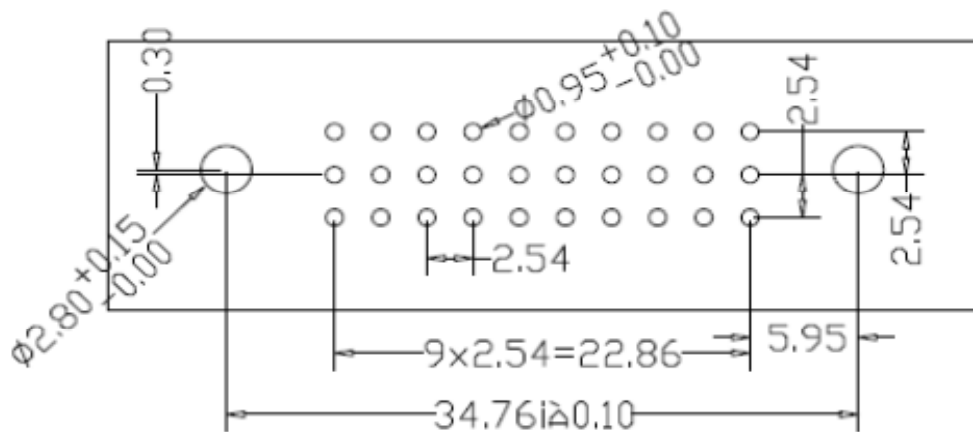

DIN41612 Connector 1/3 Size Type R Male STRAIGHT	
Part No.:	T21061-
Customer:	

DRW:	Jason	CHKD	Wilson	MATL:	Wilson	TOLERANCE	Mason	DATE	18.02.2017
APPD:	Schumi			FINISH	Jamy		Sheet No.		1 from 4

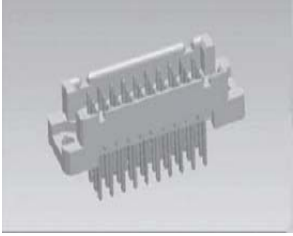

Technical Drawing

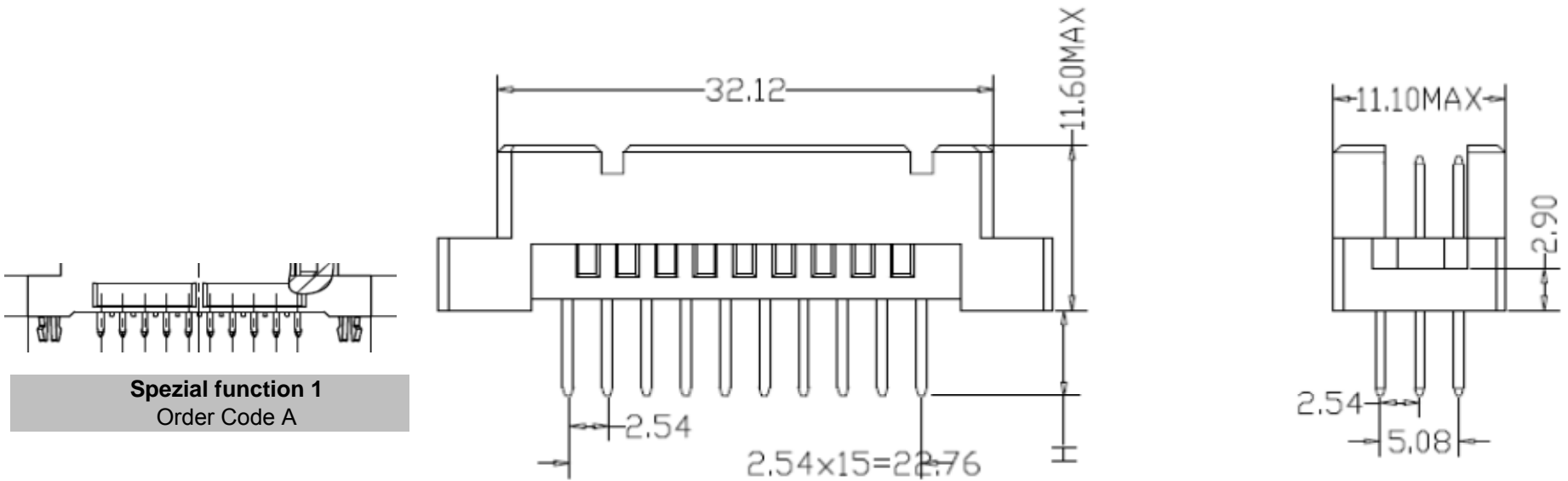

DIN41612 Connector 1/3 Size Type R Male STRAIGHT	
Part No.:	T21061-
Customer:	

DRW:	Jason	CHKD	Wilson	MATL:	Wilson	TOLERANCE	Mason	DATE	18.02.2017
APPD:	Schumi			FINISH	Jamy		Sheet No.		2 from 4

EDCON-COMPONENTS

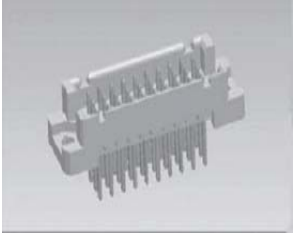

Ordering Informations

Serie	Loaded Contacts	Termination Specification	Row Loaded Contacts	Contact Plating	Special function 1	Special function	ROHS	Packing		
T21061-	10	A1	K0	S0	N	N	R	TY		

10 = Pos.	A1=Solder H=2,5mm	A0= Only Row A 2,4,6.	G0= Gold Flash	N= No Special	N= No Special	R= ROHS Conform	BU= Bulk Packing		
15 = Pos.	A2=Solder H=4,0mm	B0= Row A + B	S0= Selectiv Gold Flash/Ni	A= with SNAP- In Prong		N= NON ROHS	TY= Tray Packing		
20 = Pos.	A3=Tail IH=5,0mm	C0= Row A + C	G1= 3µ AU Gold				IV= Individual Packing		
30 = Pos.	A4=Tail H=7,4mm	F0= Row A + B + C	G2= 5µ AU Gold						
	A5=Wrap H=13mm	C2= Row A+C 2,4,6...	G3= 10µ AU Gold						
	A6=Wrap H=17mm	F2= Row A+B+C 2,4,6	G4= 15µ AU Gold						
		C1= Row A+C 1,3,5...	G5= 30µ AU Gold						
		F1= Row A+B+C 1,3,5.	S1= 3µ AU Gold / Ni	S4= 15µ AU Gold / Ni					
			S2= 5µ AU Gold / Ni	S5= 30µ AU Gold / Ni					
			S3= 10µ AU Gold / Ni	TN= Tin Plated					

Unless Otherwise specified tolerance

X=± 0,35	X.X=± 0,25	X.XX=± 0,20	X.XXX=± 0,15
DRW: Jason	CHKD	Wilson	MATL: Wilson
APPD: Schumi		FINISH	Jamy

**DIN41612 Connector 1/3 Size
Type R Male STRAIGHT**

Part No.: **T21061-**

Customer:

TOLERANCE	Mason	DATE	18.02.2017
	Sheet No.		3 from 4

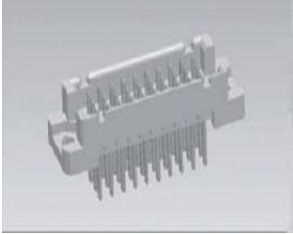

Soldering Informations

Classification Reflow Profile (JEDEC J-STD-020C)

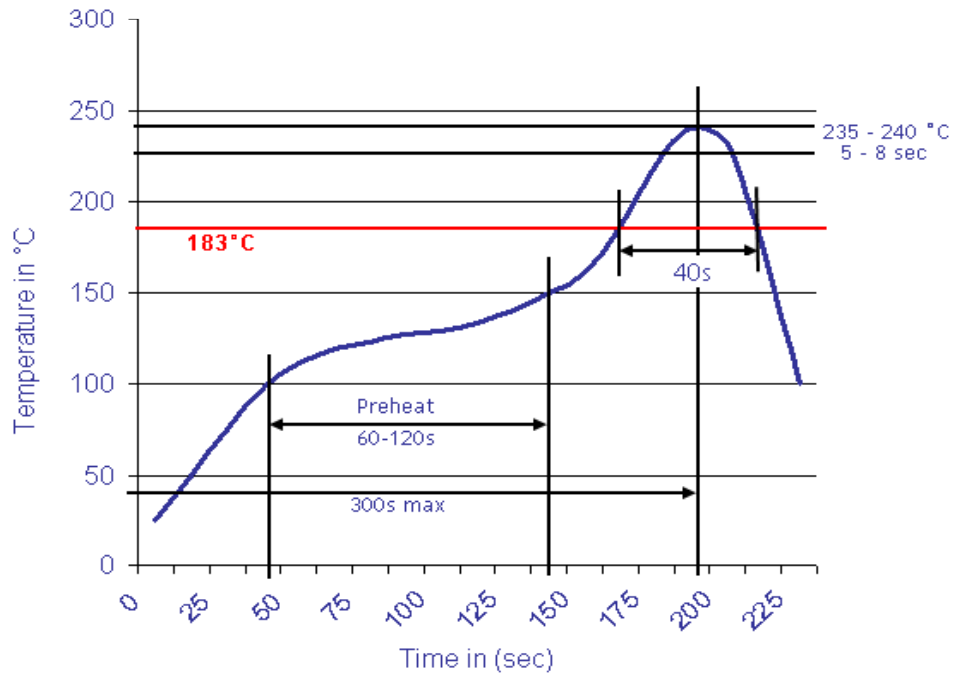

Classification Reflow Profile (JEDEC J-STD-020C)

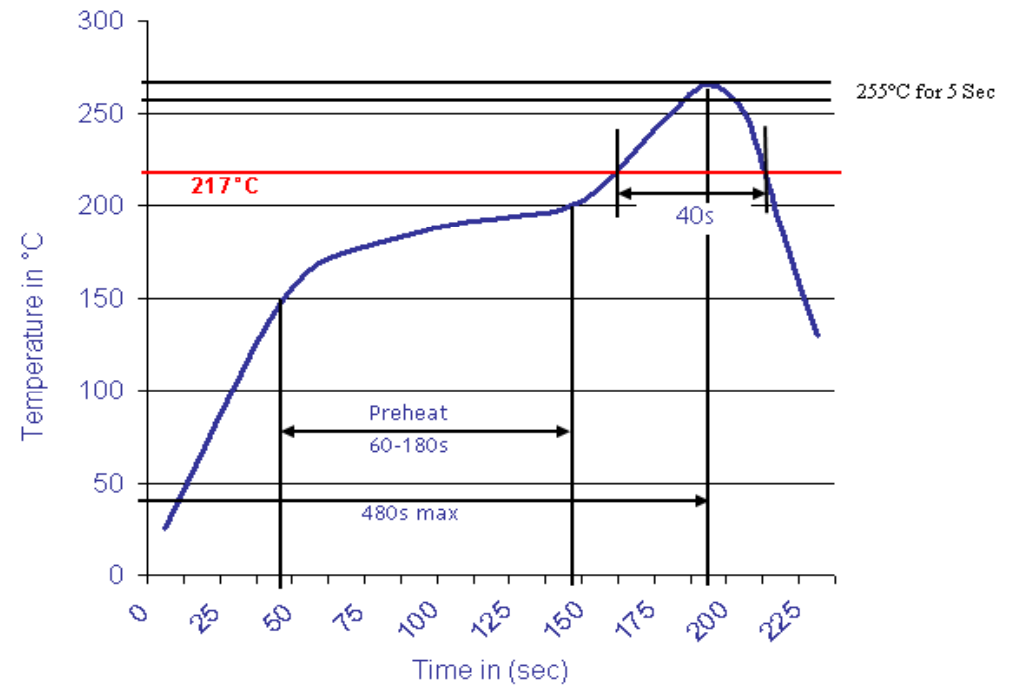

DIN41612 Connector 1/3 Size Type R Male STRAIGHT	
Part No.:	T21061-
Customer:	

DRW:	Jason	CHKD	Wilson	MATL:	Wilson	TOLERANCE	Mason	DATE	18.02.2017
APPD:	Schumi			FINISH	Jamy		Sheet No.		4 from 4