

EDCON-COMPONENTS

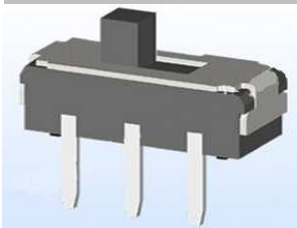

Technical Discription

Rating: DC6V, 0,3A
 Circuit: 1C-2P
 Timing: NON-Shorting
 Travel: $2,0 \pm 0,1\text{mm}$
 Contact Resistance: 70 mΩ max.
 Operating Force: 200gf \pm 100gf.

 Operating Life: 100000 cycles
 Insulation resistance: 100MΩ min.at 250VDC
 Dielectric Strength: 250VAC f. 1 Min.

Drawing

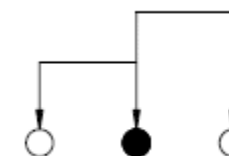
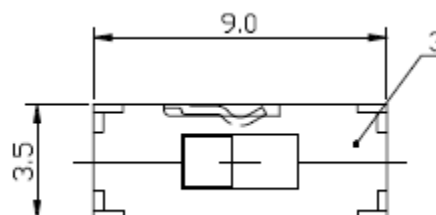
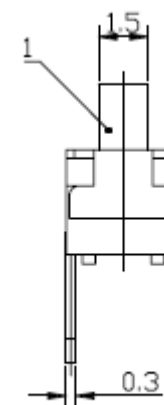
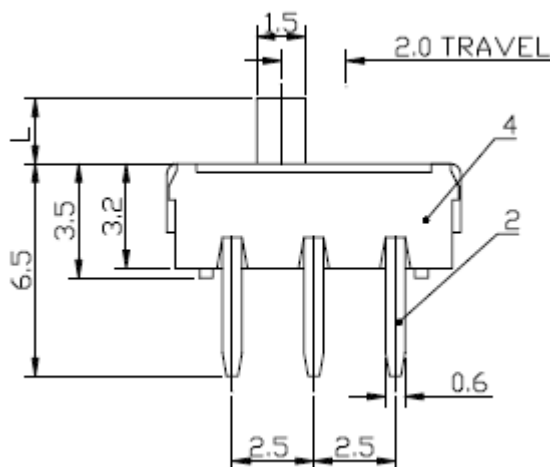

SMD-SLIDE-Switch

Part No.: **Q62012**

Customer:

DRW:	Jason	CHKD	Wilson	MATL:	Wilson	TOLERANCE	Mason	DATE	31.08.2016
APPD:	Schumi			FINISH	Jamy		Sheet No.	1 from 3	

www.edcon-components.com

email: info@edcon-components.com

EDCON-COMPONENTS

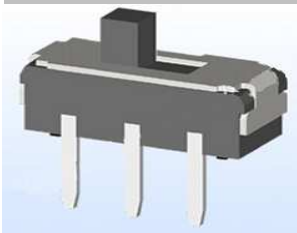

Ordering Informations

Serie	Knob Length	Knob Type	Polarisation Peg	Spezial Function	ROHS	Packing				
-------	-------------	-----------	------------------	------------------	------	---------	--	--	--	--

Q62012	A	0	Y	0	R	TR				
---------------	----------	----------	----------	----------	----------	-----------	--	--	--	--

A= 2,0mm	0= No function	Y= with Peg	0= No function	R= ROHS Conform	BU= Bulk-Ware
B= 3,0mm					TR= Tape Reel
C= 4,0mm					
D= 5,0mm					

SMD-SLIDE-Switch

Part No.: **Q62012**

DRW:	Jason	CHKD	Wilson	MATL:	Wilson	TOLERANCE	Mason	DATE	31.08.2016
APPD:	Schumi			FINISH	Jamy		Sheet No.		2 from 3

Customer:

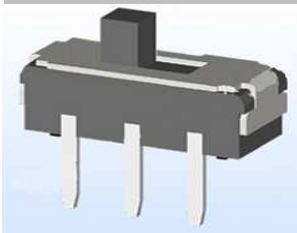

Soldering Profile Curve

Classification Reflow Profile (JEDEC J-STD-020C)



SMD-SLIDE-Switch

Part No.: **Q62012**

DRW:	Jason	CHKD	Wilson	MATL:	Wilson	TOLERANCE	Mason	DATE	31.08.2016
APPD:	Schumi			FINISH	Jamy		Sheet No.	3 from 3	Customer: