

EDCON-COMPONENTS

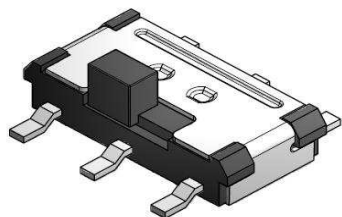

Technical Description

Rating: DC4V, 0,3A
 Circuit: 2C-2P
 Timing: NON-Shorting
 Travel: $1,5 \pm 0,1\text{mm}$
 Contact Resistance: $70\text{ m}\Omega\text{ max.}$
 Operating Force: $200 \pm 150\text{gf}$
 Operating Life: 10000 cycles

Drawing

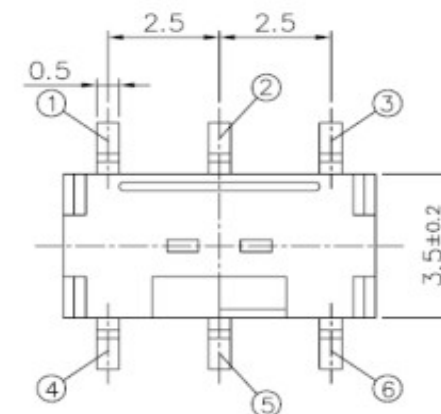
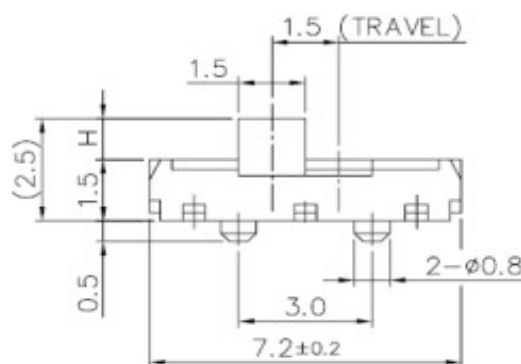

PCB Layout

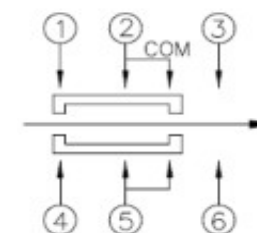
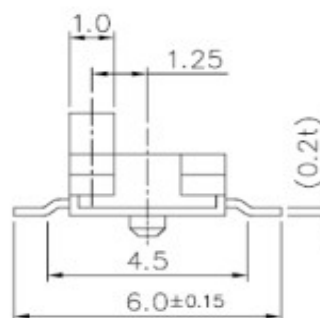
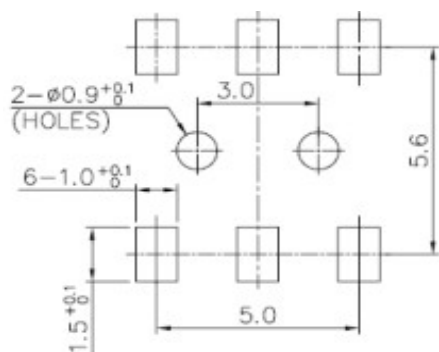

**SMD-SLIDE-Switch
1,5mm Height**

Part No.: **Q62011**

DRW:	Jason	CHKD	Wilson	MATL:	Wilson	TOLERANCE	Mason	DATE	30.08.2016
APPD:	Schumi			FINISH	Jamy		Sheet No.	1 from 3	Customer:

www.edcon-components.com

email: info@edcon-components.com

EDCON-COMPONENTS

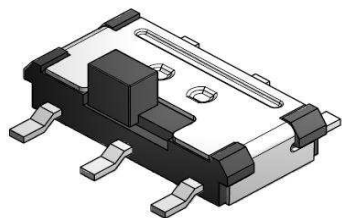

Ordering Informations

Serie	Knob Length (H)	Knob Type	Polarisation Peg	Spezial Function	ROHS	Packing				
-------	-----------------	-----------	------------------	------------------	------	---------	--	--	--	--

Q62011	A	0	Y	0	R	TR				
---------------	----------	----------	----------	----------	----------	-----------	--	--	--	--

A= 1mm	0= No function	Y= with Peg	0= No function	R= ROHS Conform	BU= Bulk-Ware TR= Tape Reel
B= 2mm					
C= 3mm					

**SMD-SLIDE-Switch
1,5mm Height**

Part No.: **Q62011**

DRW:	Jason	CHKD	Wilson	MATL:	Wilson	TOLERANCE	Mason	DATE	30.08.2016
APPD:	Schumi			FINISH	Jamy		Sheet No.		2 from 3

Customer:

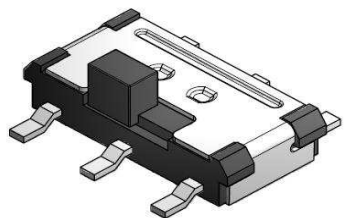

Soldering Profile Curve

Classification Reflow Profile (JEDEC J-STD-020C)



**SMD-SLIDE-Switch
1,5mm Height**

Part No.: **Q62011**

DRW:	Jason	CHKD	Wilson	MATL:	Wilson	TOLERANCE	Mason	DATE	30.08.2016	Customer:
APPD:	Schumi			FINISH	Jamy		Sheet No.	3 from 3		