

EDCON-COMPONENTS

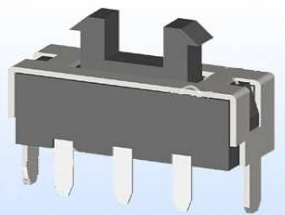

Technical Discription

Rating: DC30V, 0,1A
 Circuit: 1C - 2P
 Timing: NON-Shorting
 Travel: $2,0 \pm 0,1\text{mm}$
 Contact Resistance: 100 mΩ max.
 Operating Force: 200gf \pm 100gf.

 Operating Life: 100000 cycles
 Insulation resistance: 100MΩ min.at 250VDC
 Dielectric Strnegth: 250VAC f. 1 Min.

Drawing

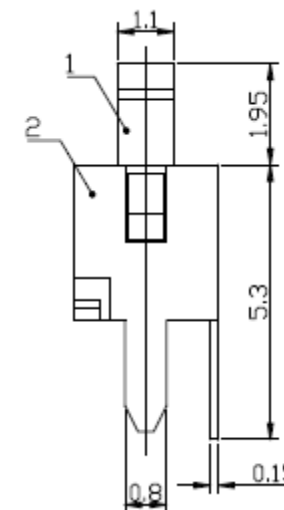
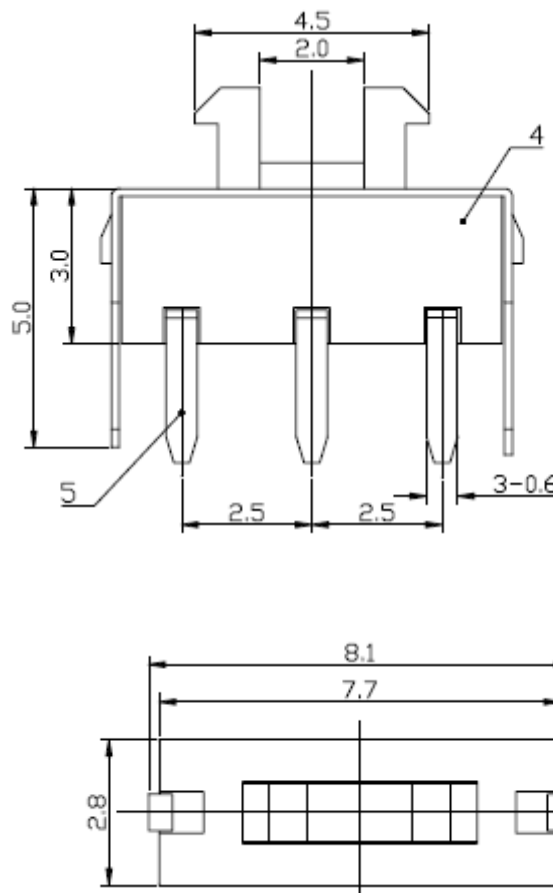

PCB Layout

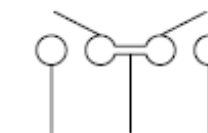
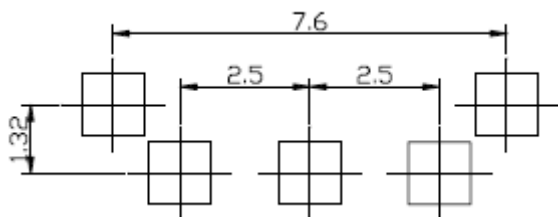

SMD-SLIDE-Switch

Part No.: **Q62003**

Customer:

DRW:	Jason	CHKD	Wilson	MATL:	Wilson	TOLERANCE	Mason	DATE	01.09.2016
APPD:	Schumi			FINISH	Jamy		Sheet No.	1 from 3	

EDCON-COMPONENTS

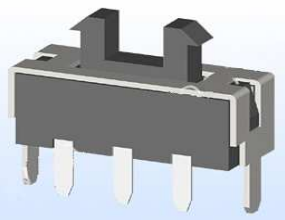

Ordering Informations

Serie	Knob Length	Knob Type	Polarisation Peg	Spezial Function	ROHS	Packing				
-------	-------------	-----------	------------------	------------------	------	---------	--	--	--	--

Q62003	A	0	0	0	R	TR				
---------------	----------	----------	----------	----------	----------	-----------	--	--	--	--

A= 1,95mm	0= No function	0= without Peg	0= No function	R= ROHS Conform	BU= Bulk-Ware
					TR= Tape Reel

SMD-SLIDE-Switch

Part No.: **Q62003**

DRW:	Jason	CHKD	Wilson	MATL:	Wilson	TOLERANCE	Mason	DATE	01.09.2016
APPD:	Schumi			FINISH	Jamy		Sheet No.	2 from 3	Customer:

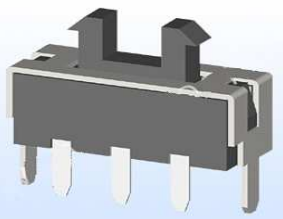

Soldering Profile Curve

Classification Reflow Profile (JEDEC J-STD-020C)



SMD-SLIDE-Switch

Part No.: **Q62003**

DRW:	Jason	CHKD	Wilson	MATL:	Wilson	TOLERANCE	Mason	DATE	01.09.2016
APPD:	Schumi			FINISH	Jamy		Sheet No.	3 from 3	Customer: