

EDCON-COMPONENTS

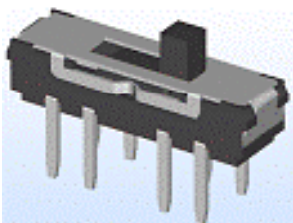

SPECIFICATION:

Current Rating:	0,3 Ampere / 5VDC
Insulator Resistance:	100 Megaohm min. at 500VDC
Dielectric Withstanding:	AC 500V
Operating Temperature:	.-40°C to +105°C
Contact Resistance:	70m Ω max.
Timing:	Shorting
Function:	2P3T
Lifetest:	10000 cycles
Contact Material:	PBS
Cover:	SUS Nature
Terminal:	Brass strip Ag plated
Case Material:	Nylon
Knob Material:	Nylon
Contact Clip:	PBS-Strip

Drawing

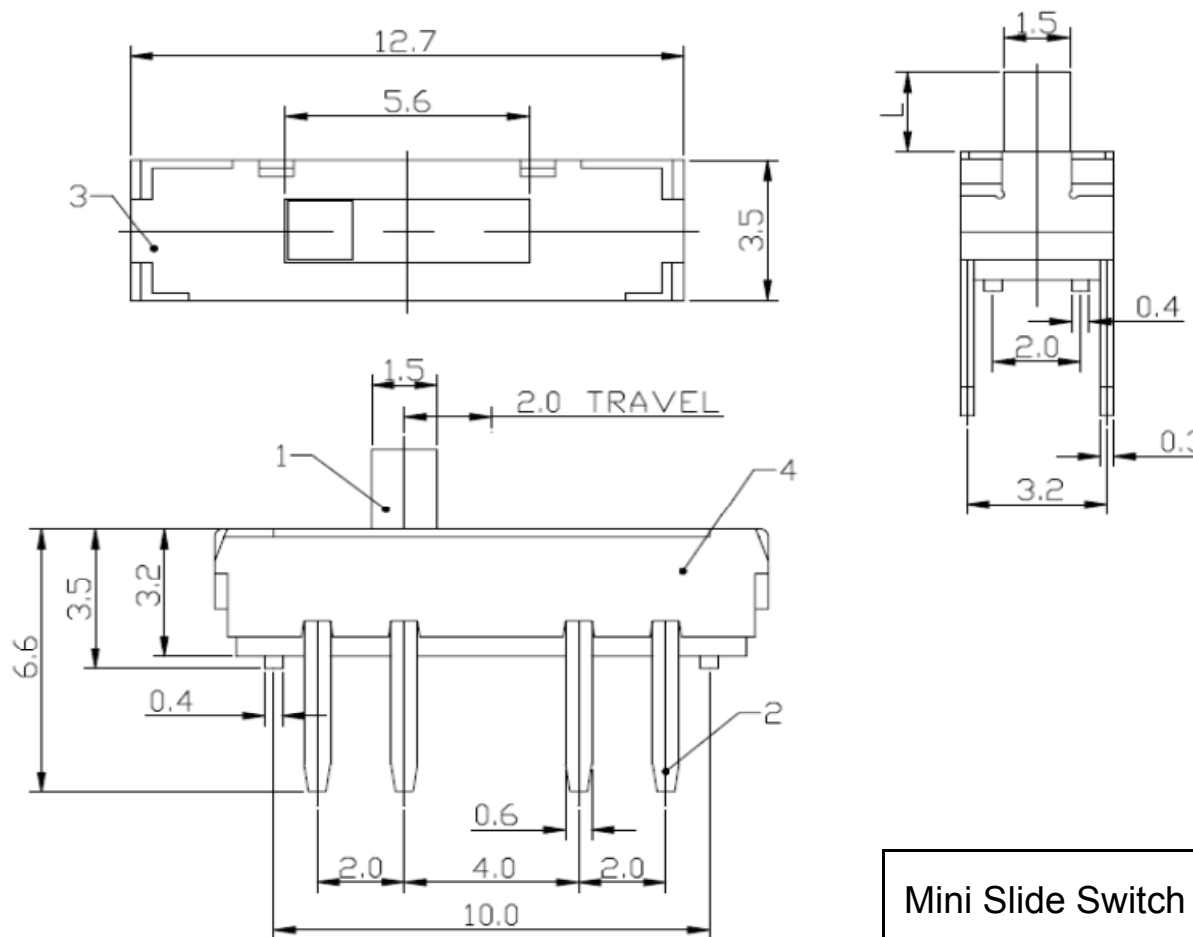

Schematic

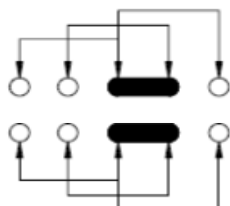

Mini Slide Switch 2P3T

Part No.: **Q61011**

Customer:

<=5mm +/-0,1mm		>=5mm +/-0,2mm		Angle Tol. +/-2°					
DRW:	Jason	CHKD	Wilson	MATL:	Wilson	Mason	DATE	05.05.2020	
APPD:	Schumi			FINISH	Jamy	MSS23D18	Sheet No.	1 from 3	

www.edcon-components.com

email: info@edcon-components.com

Copyright by S.Tiede

EDCON-COMPONENTS

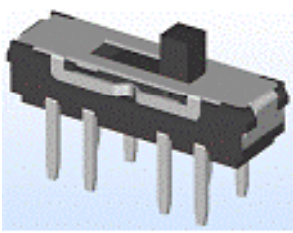

Ordering Informations

Serie	Knob Length	Special function	Electrical life	Special function	ROHS	Packing				
Q61011	020	N	103	N	R	BU				

020 = 2,0mm	N = No function	103 = 10000 Cycles	N = No function	N = non ROHS	BU = Bulk Ware		
030 = 3,0mm				R = ROHS conform	IV = Individual Package		
040 = 4,0mm							
050 = 5,0mm							

Mini Slide Switch 2P3T	
Part No.:	Q61011
Customer:	

DRW:	Jason	CHKD	Wilson	MATL:	Wilson	TOLERANCE	Mason	DATE	05.05.2020
APPD:	Schumi			FINISH	Jamy		Sheet No.		2 from 3

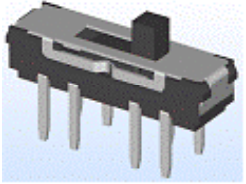

Soldering Profile for Lead Free Soldering (P.B.T.)

Classification Reflow Profile (JEDEC J-STD-020C)

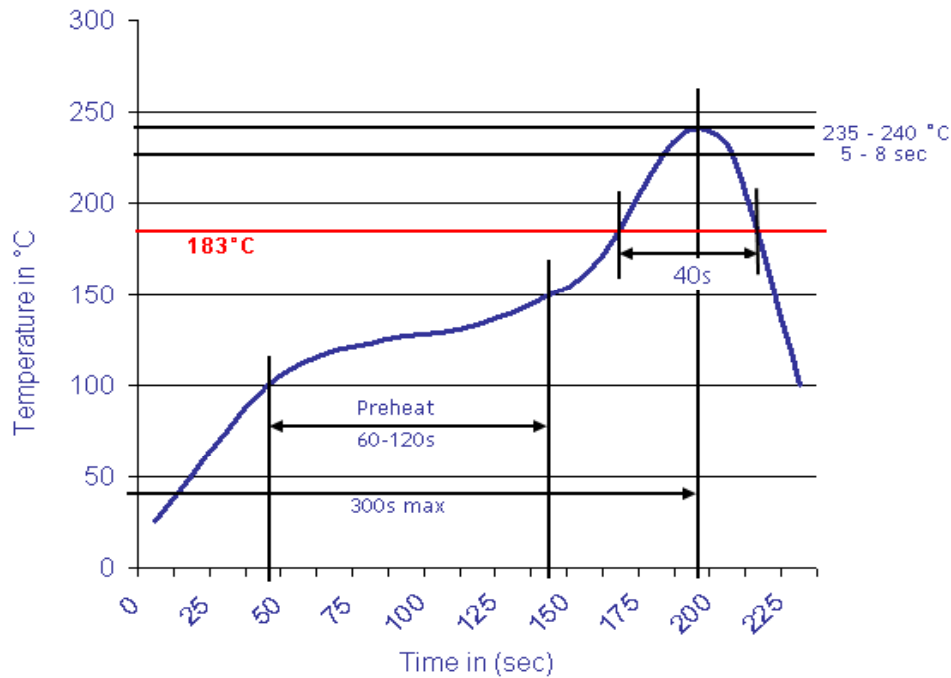

Soldering Profile for Lead Free Soldering (Nylon 6T)

Classification Reflow Profile (JEDEC J-STD-020C)

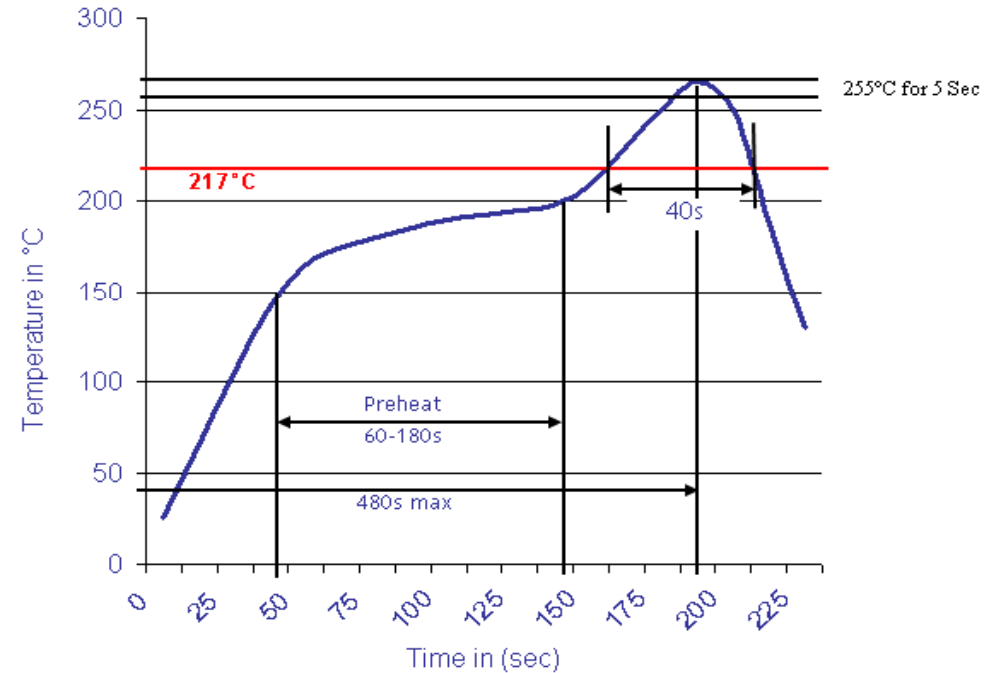

Mini Slide Switch 2P3T

Part No.: **Q61011**

Customer:

DRW:	Jason	CHKD	Wilson	MATL:	Wilson	TOLERANCE	Mason	DATE	05.05.2020
APPD:	Schumi			FINISH	Jamy		Sheet No.		3 from 3