

EDCON-COMPONENTS

Data Sheet Valve Connector 3 + PE



Technical Specification

Construction Type:	A
Standard:	DIN EN 175 301-803-A
Temperature rated:	-40°C ~ +125°C
Locking System:	Central screw (M3x35mm)
Termination:	soldering
Pin Dimension:	6,3x0,8mm
Mechanical Operation:	> 50 mating cycles
Protection grade:	IP65
Color:	Black

Electrical Specification

Rated voltage:	250V
Rated impulse voltage:	800V/4000V
Rated current:	16A
Insulation resistance:	>20 M Ohm
Contact resistance:	< 4 milli Ohm

Material

Body:	PA
Contact:	Ps w. copper plating
Screw:	steel w. Zn plating

Technical Drawing

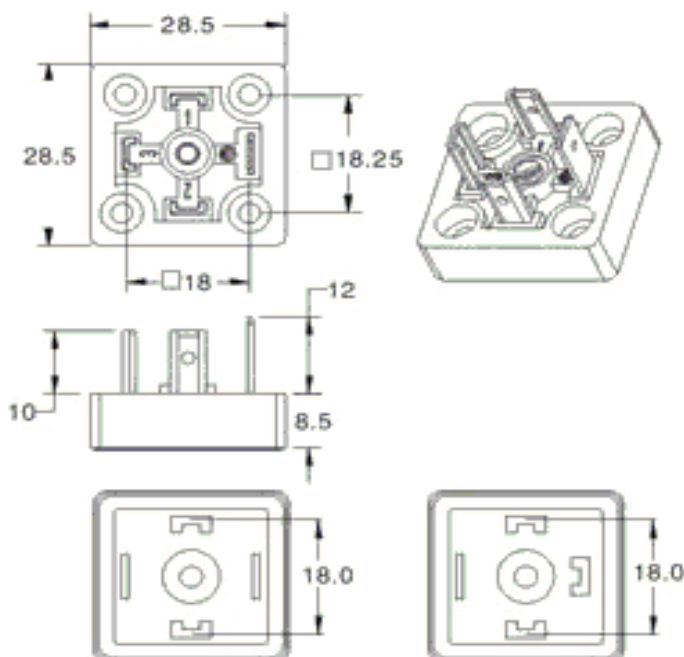

Valve Connector Serie FINECABLES

EDCON-COMPONENTS

Data Sheet Valve Connector 3 + PE



Valve Connector Serie FINECABLES

Ordering Information

Serie	Type					
T83002	3+PE					
	3pos + PE					