

EDCON-COMPONENTS

Data Sheet M12 Serie



Technical Specification

Connector Type	Sensor (M-Serie)
Connector Spec.	M12 Sensor Connector
Number of contacts	3 contacts
Shielding:	No
Connector Body	Metall / Plastic
Contact Type	Female Type
Assembly Style	Molded Style
Insert:	PA + GF
Contact Mat.:	Brass w. Gold Plating
Scre Nut:	Brass w. Nickel Plated
O-Ring:	FKM
Overmold:	TPU
Cable Type:	PVC Cable
Conductor:	0,34mm ² max.
Wire Isolation:	PVC
Wire Color:	Brown,Blue,Black
Jacket:	PVC
Jacket Color:	Black (other colors option
Cable length:	Max. 99 Meter.
Code:	A

Electrical Specification

Standard:	IEC 60947-5-2
Operating Temperature	.-10°C ~ +70°C
Poles:	3 contacts
Rated Current:	4A
Nominal Voltage:	250V/AC 300V/DC
Insulation Resistance:	> 20M Ohm
Contact Resistance:	< 5 milli Ohm
Degree of Protection:	IP67
Only in locked position with ist proper counterparts	

Technical Drawing

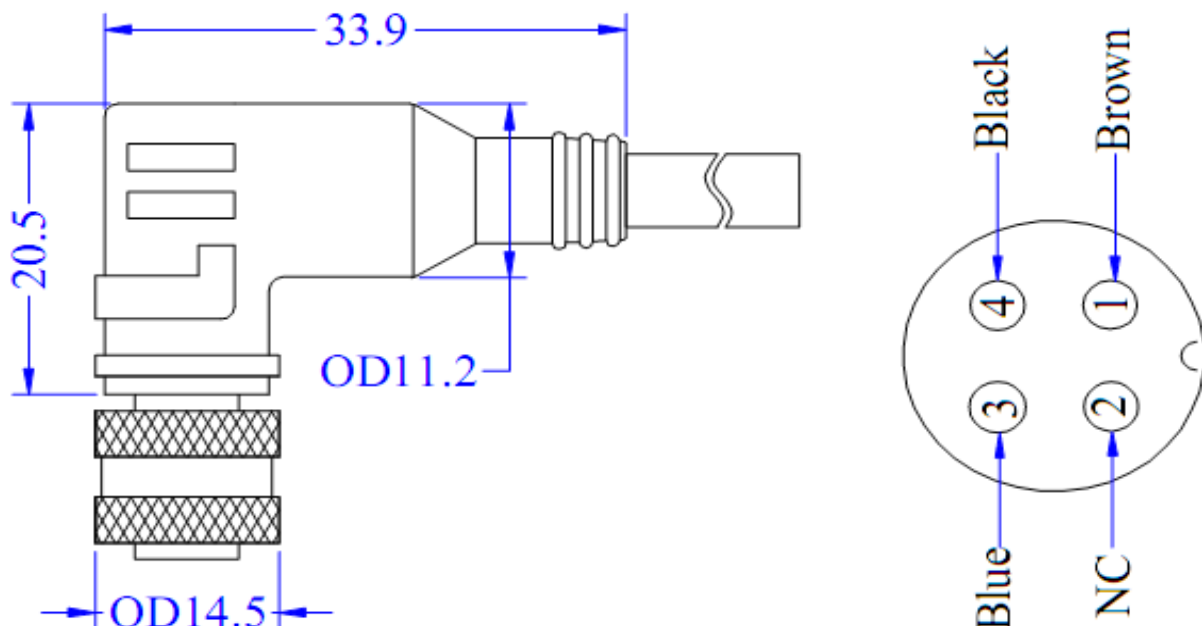

Sensor Connector Type M12

EDCON-COMPONENTS

Data Sheet M12 Serie



Sensor Connector Type M12

Ordering Information

Serie	Contacts	Connector type	Cable Colour	Length of cable	Style side two	
T61126	3	F	BK	xxxxx	C	
	3= 3 contacts	F= Female	BK = Black (Standard) other colors on request	00100 = 100mm 01000 = 1,0Meter	C= Cut Type A= 100mm open end 5mm tinned ends	