

EDCON-COMPONENTS

Data Sheet M12 Serie



Technical Specification

Connector Type	Sensor (M-Serie)
Connector Spec.	M12 Sensor Connector
Number of contacts	3 contacts
Connector Body	Metall / Plastic
Contact Type	Female Type
Assembly Style	Cable Style
Insert:	PA + GF
Contact Mat.:	Brass w. Gold Plating
Screw/Nut:	Brass w. Nickel Plating
O-Ring:	FKM
Body:	PA + Glass fiber
Color:	Black
Conductor:	0,75mm ² max.
Cable Diameter:	4-6mm
Cable Gland:	PG7
Code:	A

Electrical Specification

Standard:	IEC 60947-5-2
Operating Temperature	.-25°C ~ +90°C
Poles:	3 contacts
Rated Current:	4A
Nominal Voltage:	250V/AC / 300VDC
Insulation Resistance:	> 20M Ohm
Contact Resistance:	< 5 milli Ohm
Degree of Protection:	IP67
Only in Locked position with ist proper counterparts	

Technical Drawing

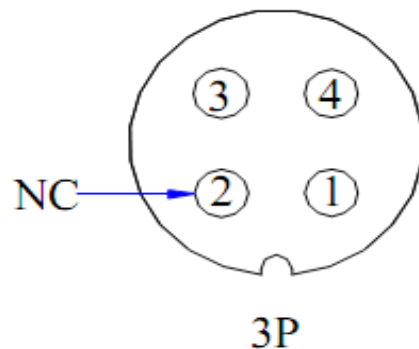
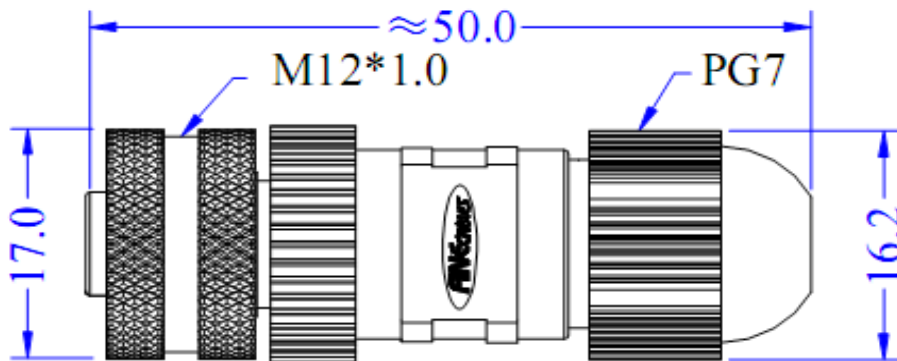

Sensor Connector Type M12

EDCON-COMPONENTS

Data Sheet M12 Serie



Sensor Connector Type M12

Ordering Information

Serie	Contacts	Connector type	Cable Colour	Length of cable	Style side two	
T61066	3	F	BK	xxxxx	C	
	3= 3 contacts	F= Female	BK = Black (Standard) other colors on request	00100 = 100mm 01000 = 1,0Meter	C= Cut Type A= 100mm open end 5mm tinned ends	