

EDCON-COMPONENTS

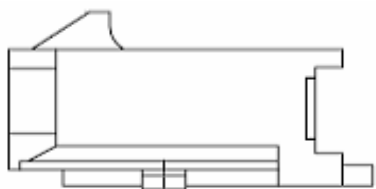

Specifications

Current Rating:	5,0A
Insulation Resistance:	1000M Ohm min.
Contact Resistance:	10milli Ohm max.
Dielectric Voltage:	1500V AC for one minute
Operating Temperature:	-25°C ~ to +85°C
Insulator Material:	High Temperature Plastic UL94V
Contact Pin:	Brass
Contact Plating:	Sn over Ni.

Drawing

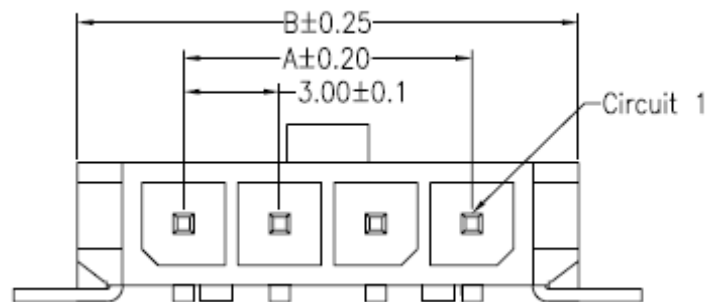

PCB Layout

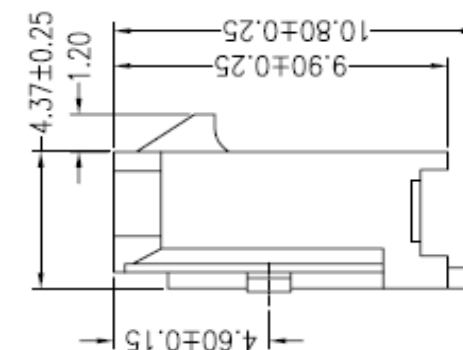
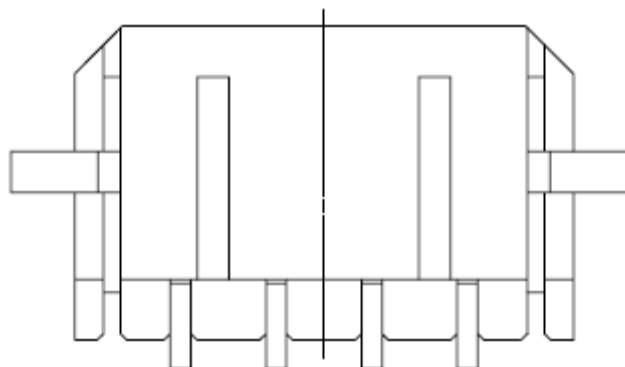
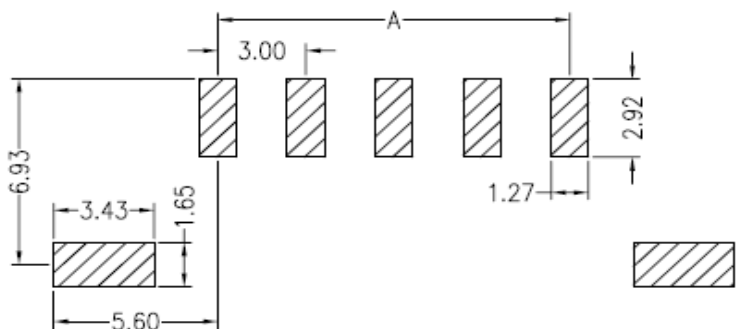

**MICRO FIT CONNECTOR
3,00mm**

Part No.: **T48020**

DRW:	Jason	CHKD	Wilson	MATL:	Wilson	TOLERANCE	Mason	DATE	10.04.2009
APPD:	Schumi			FINISH	Jamy		Sheet No.	1 from 4	Customer:

www.edcon-components.com

email: info@edcon-components.com

EDCON-COMPONENTS



Ordering Informations

Serie	No. of Pos.	Contact Plating	Plastic Material	Color	ROHS	Packing				
T48020	XX	T0	HT	BK	R	BU				

XX =2, 3, 4, 5, 6, 7, 8, 9, 10, 11, 12	T0 = Tin plated	HT = High Temperatur Plastic	BK = Black	N =NO ROHS conform	BU = Bulk Ware
				R =ROHS conform	TU = Tube Packing w. Cap
					TR = Tape / Reel

MICRO FIT CONNECTOR 3,00mm	
Part No.:	T48020
Customer:	

DRW:	Jason	CHKD	Wilson	MATL:	Wilson	TOLERANCE	Mason	DATE	10.04.2009
APPD:	Schumi			FINISH	Jamy		Sheet No.		3 from 4

EDCON-COMPONENTS



Soldering Profile for Lead Soldering (P.B.T.)

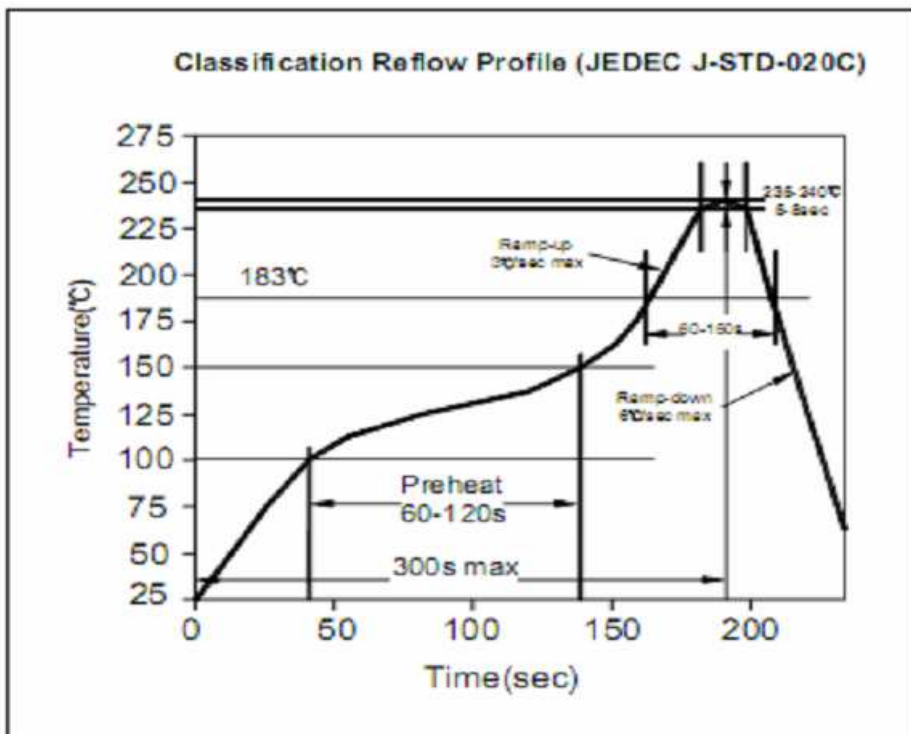

Soldering Profile for Lead Free Soldering (Nylon 6T)

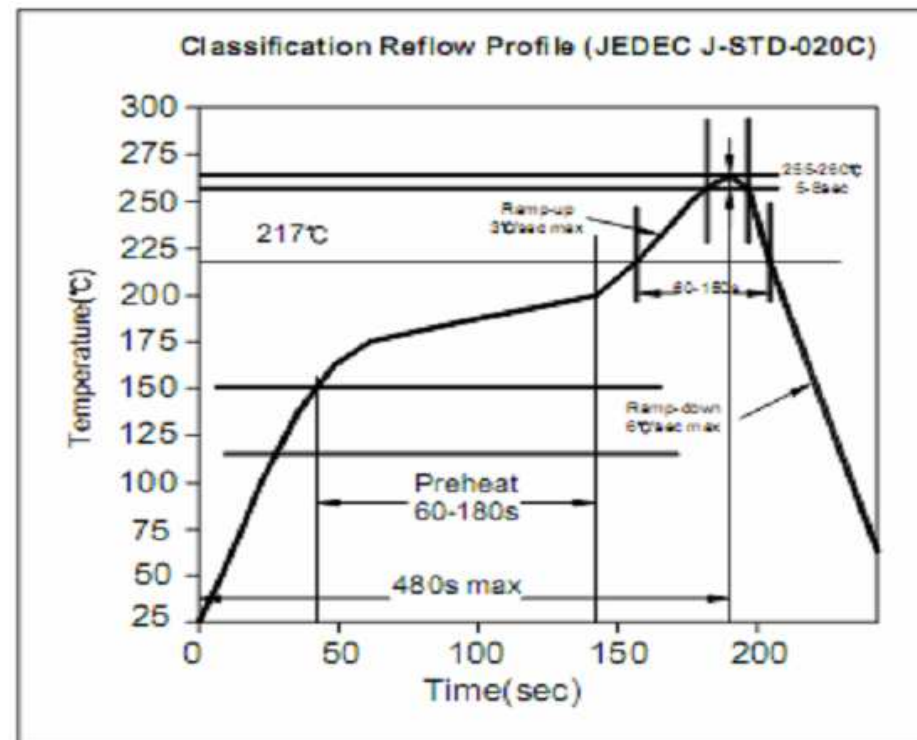

**MICRO FIT CONNECTOR
3,00mm**

Part No.: **T48020**

DRW:	Jason	CHKD	Wilson	MATL:	Wilson	TOLERANCE	Mason	DATE	10.04.2009
APPD:	Schumi			FINISH	Jamy		Sheet No.	4 from 4	Customer:

www.edcon-components.com

email: info@edcon-components.com