

# EDCON-COMPONENTS

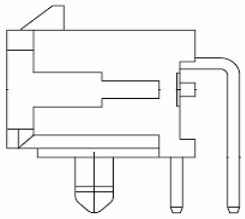

## Specifications

Current Rating:	5,0A
Insulation Resistance:	1000M Ohm min.
Contact Resistance:	10milli Ohm max.
Dielectric Voltage:	1500V AC for one minute
Operating Temperature:	. -25°C ~ to +85°C
Insulator Material:	High Temperature Plastic UL94V
Contact Pin:	Brass
Contact Plating:	Sn over Ni.

## PCB Layout

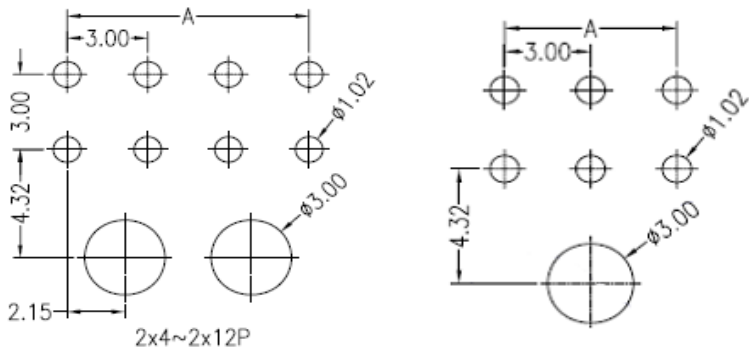

## Drawing

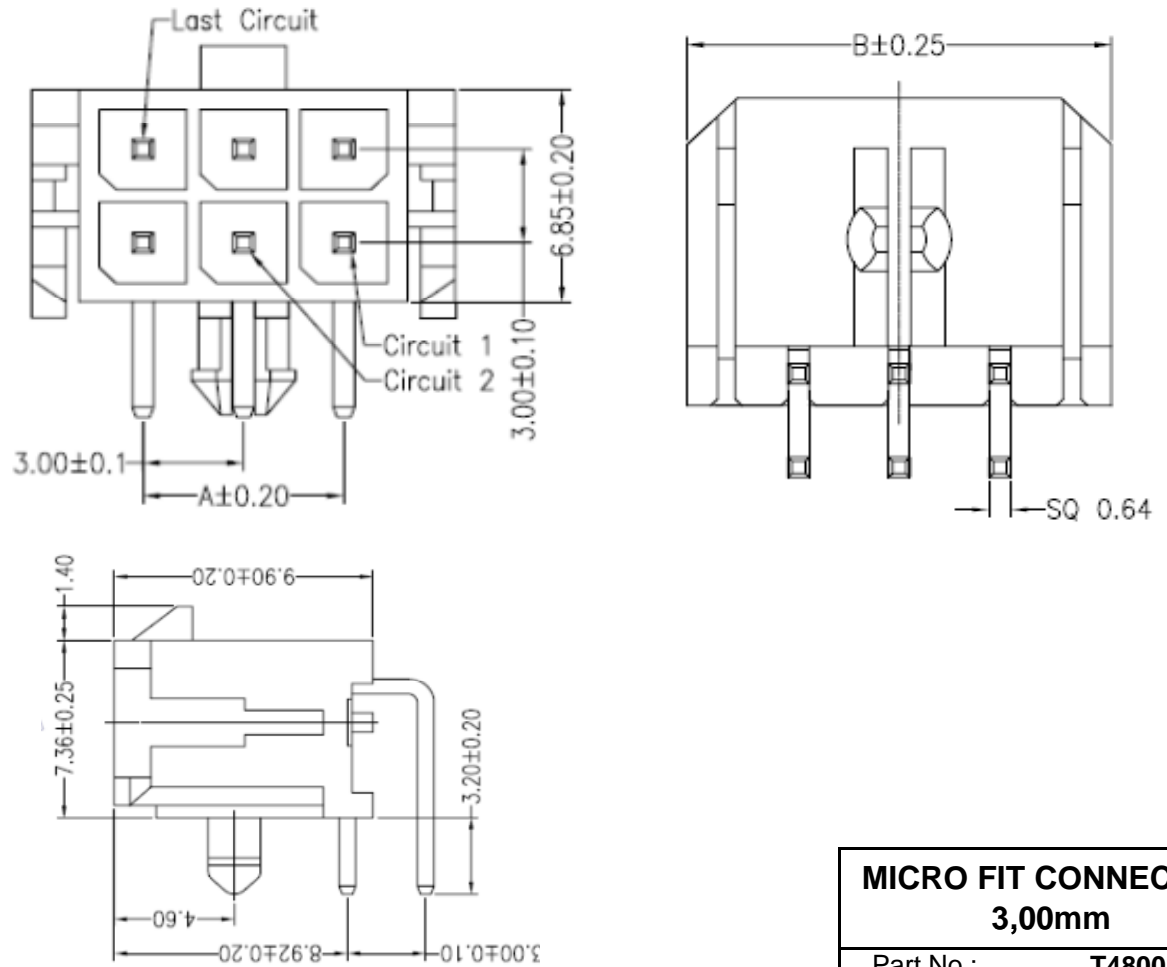

<b>MICRO FIT CONNECTOR</b>	
<b>3,00mm</b>	
Part No.:	<b>T48008</b>
Customer:	

DRW:	Jason	CHKD	Wilson	MATL:	Wilson	TOLERANCE	Mason	DATE	26.03.2021
APPD:	Schumi			FINISH	Jamy		Sheet No.		1 from 4

[www.edcon-components.com](http://www.edcon-components.com)

email: [info@edcon-components.com](mailto:info@edcon-components.com)



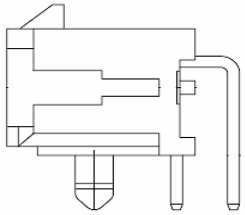

**Ordering Informations**

Serie	No. of Pos.	Contact Plating	Plastic Material	Color	ROHS	Packing				
<b>T48008</b>	<b>XX</b>	<b>T0</b>	<b>HT</b>	<b>BK</b>	<b>R</b>	<b>BU</b>				

<b>XX</b> =2, 3, 4, 5, 6, 7, 8, 9, 10, 11, 12	<b>T0</b> = Tin plated	<b>HT</b> = High Temperatur Plastic	<b>BK</b> = Black	<b>N</b> =NO ROHS	<b>BU</b> = Bulk Ware
	<b>G0</b> = Gold flash plated			<b>R</b> =ROHS conform	<b>TU</b> = Tube Packing w. Cap
	<b>GA</b> = 15µ Gold plated	<b>TR</b> = Tape / Reel			

<b>MICRO FIT CONNECTOR 3,00mm</b>	
Part No.:	<b>T48008</b>
Customer:	

DRW:	Jason	CHKD	Wilson	MATL:	Wilson	TOLERANCE	Mason	DATE	26.03.2021
APPD:	Schumi			FINISH	Jamy		Sheet No.		3 from 4

[www.edcon-components.com](http://www.edcon-components.com)

email: [info@edcon-components.com](mailto:info@edcon-components.com)

Copyright by S.Tiede  
**EDCON-COMPONENTS**



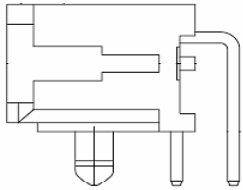

**Soldering Profile for Lead Soldering ( P.B.T. )**

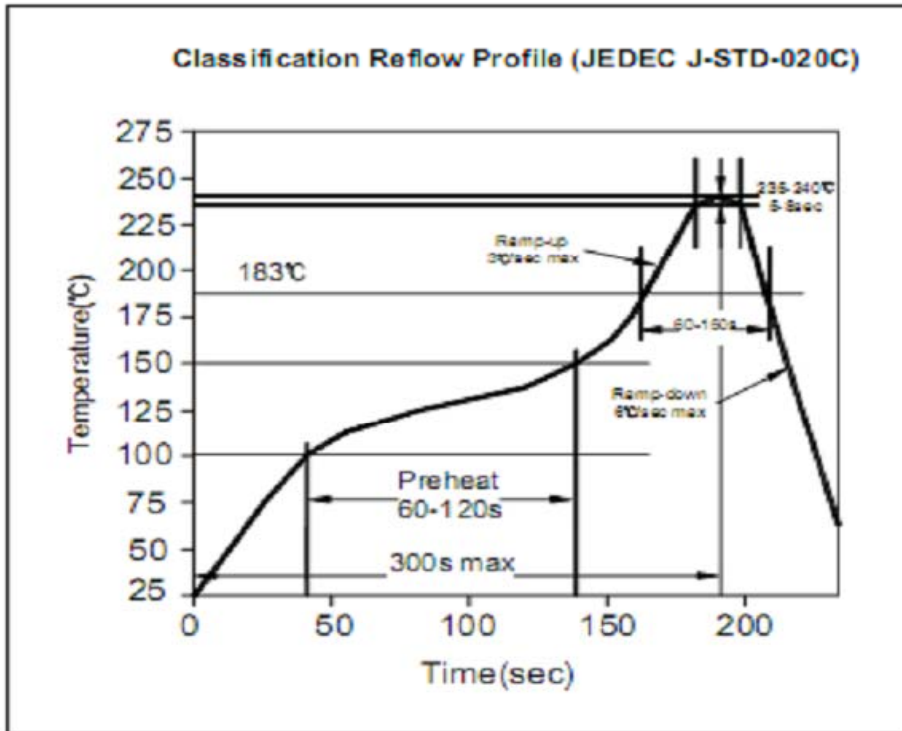

**Soldering Profile for Lead Free Soldering ( Nylon 6T )**

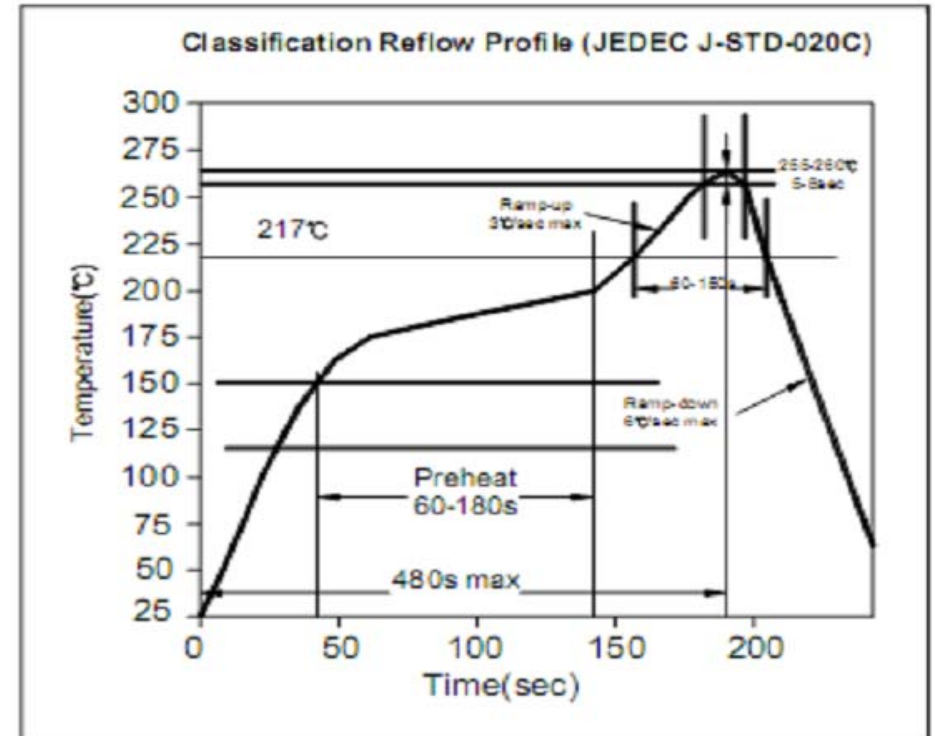

<b>MICRO FIT CONNECTOR 3,00mm</b>	
Part No.:	<b>T48008</b>
Customer:	

DRW:	Jason	CHKD	Wilson	MATL:	Wilson	TOLERANCE	Mason	DATE	26.03.2021
APPD:	Schumi			FINISH	Jamy		Sheet No.	4 from 4	

[www.edcon-components.com](http://www.edcon-components.com)

email: [info@edcon-components.com](mailto:info@edcon-components.com)