

EDCON-COMPONENTS

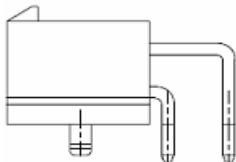

Specifications

Current Rating:	9,0A
Insulation Resistance:	1500M Ohm min.
Contact Resistance:	20milli Ohm max.
Dielectric Voltage:	600V AC for one minute
Operating Temperature:	. -25°C ~ to +85°C
Insulator Material:	High Temperature Plastic UL94V
Contact Pin:	Brass
Contact Plating:	Sn over Ni.
	Stamped Pin

PCB Layout

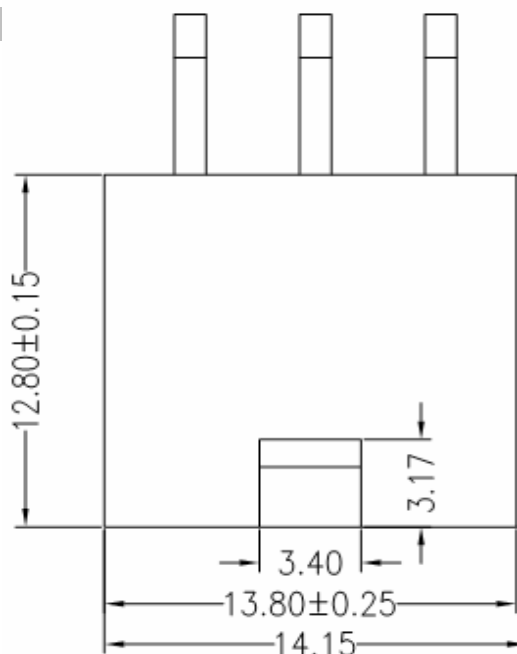
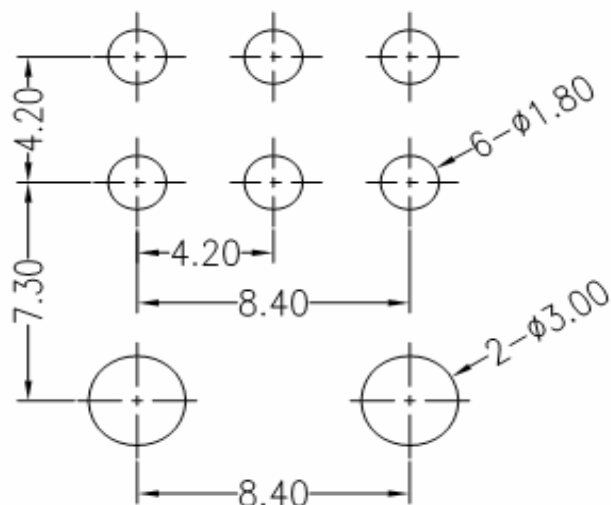

Drawing

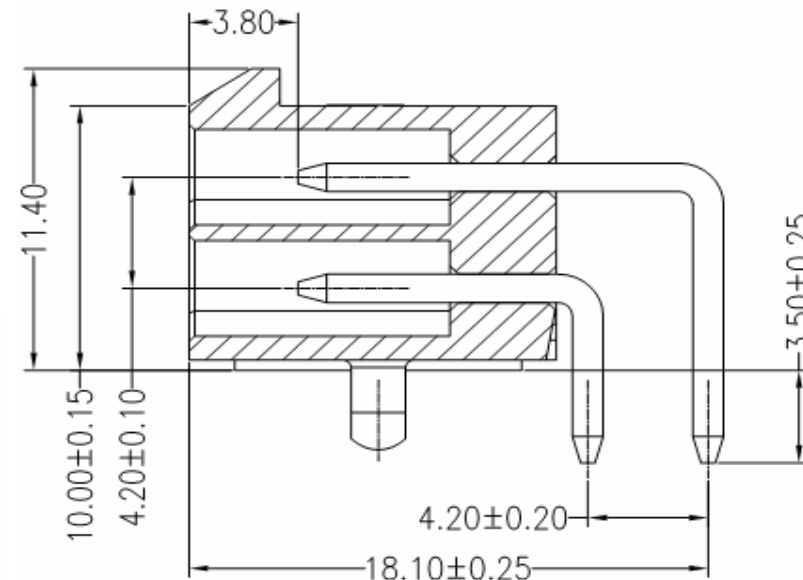

MINI FIT CONNECTOR
4,20mm

Part No.: **T45023**

DRW:	Jason	CHKD	Wilson	MATL:	Wilson	TOLERANCE	Mason	DATE	10.04.2009
APPD:	Schumi			FINISH	Jamy		Sheet No.	1 from 4	Customer:

EDCON-COMPONENTS

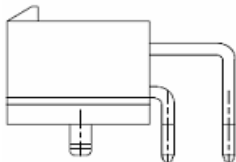

Ordering Informations

Serie	No. of Pos.	Contact Plating	Plastic Material	Color	ROHS	Packing				
T45023	XX	T0	HT	WH	R	BU				

XX= 6	T0= Tin plated	HT= High Temperatur Plastic	WH= White	N= NO ROHS conform	BU= Bulk Ware (Standard)
				R= ROHS conform	TU= Tube Packing

**MINI FIT CONNECTOR
4,20mm**

Part No.: **T45023**

DRW:	Jason	CHKD	Wilson	MATL:	Wilson	TOLERANCE	Mason	DATE	10.04.2009
APPD:	Schumi			FINISH	Jamy			Sheet No.	3 from 4

Customer:

EDCON-COMPONENTS

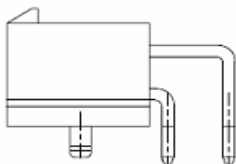

Soldering Profile for Lead Soldering (P.B.T.)

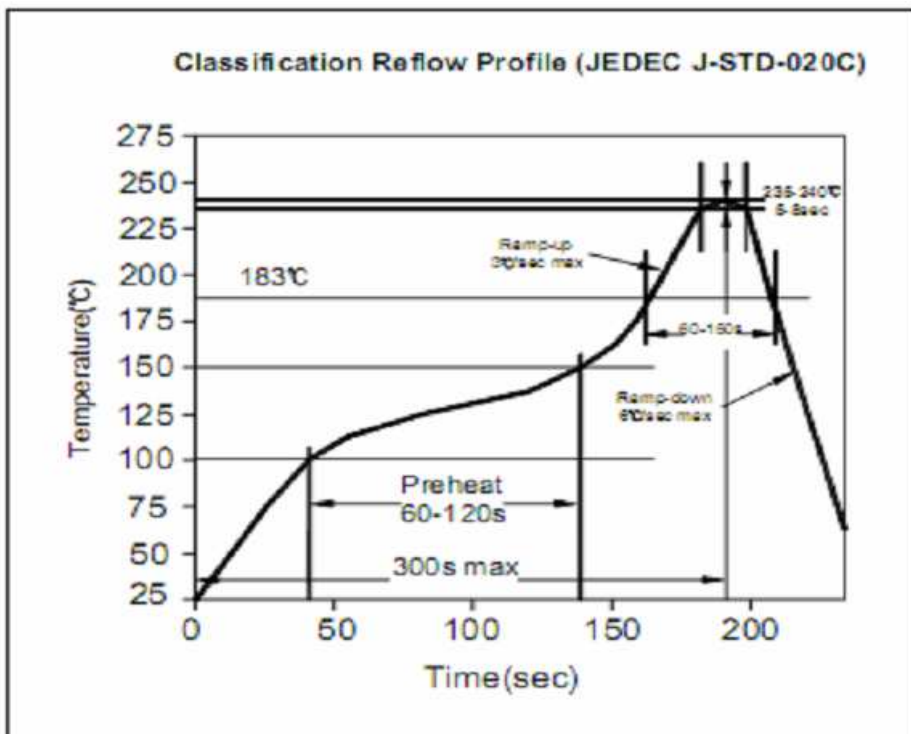

Soldering Profile for Lead Free Soldering (Nylon 6T)

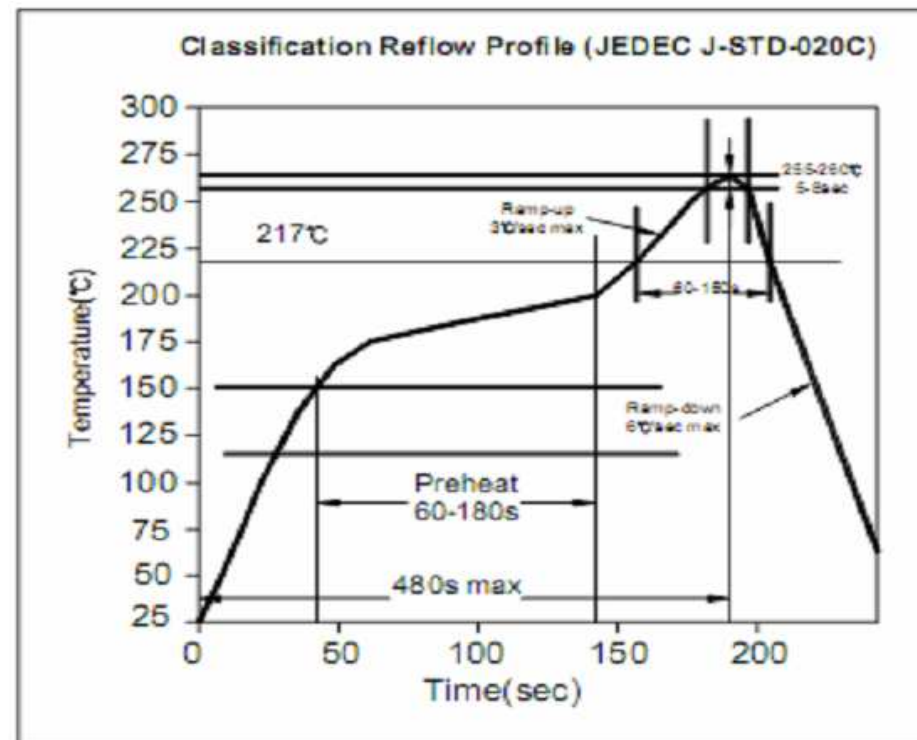

**MINI FIT CONNECTOR
4,20mm**

Part No.: **T45023**

DRW:	Jason	CHKD	Wilson	MATL:	Wilson	TOLERANCE	Mason	DATE	10.04.2009	Customer:
APPD:	Schumi			FINISH	Jamy		Sheet No.	4 from 4		

www.edcon-components.com

email: info@edcon-components.com