

# EDCON-COMPONENTS

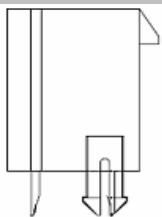

## Specifications

Current Rating:	9,0A
Insulation Resistance:	1500M Ohm min.
Contact Resistance:	20milli Ohm max.
Dielectric Voltage:	600V AC for one minute
Operating Temperature:	. -25°C ~ to +85°C
Insulator Material:	High Temperature Plastic UL94V
Contact Pin:	Brass
Contact Plating:	Sn over Ni.
	Stamped Pin

## PCB Layout

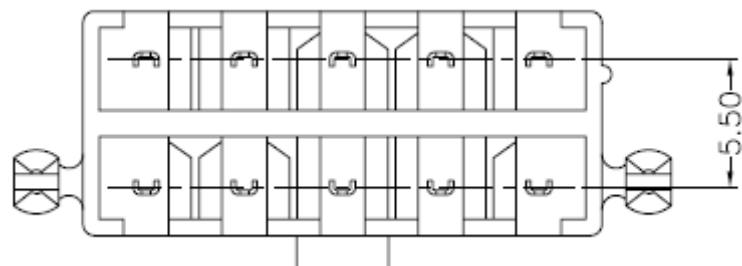
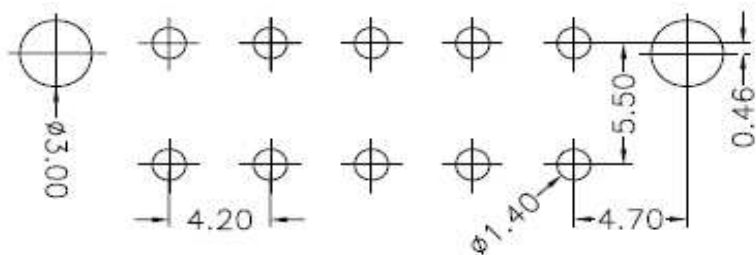

## Drawing

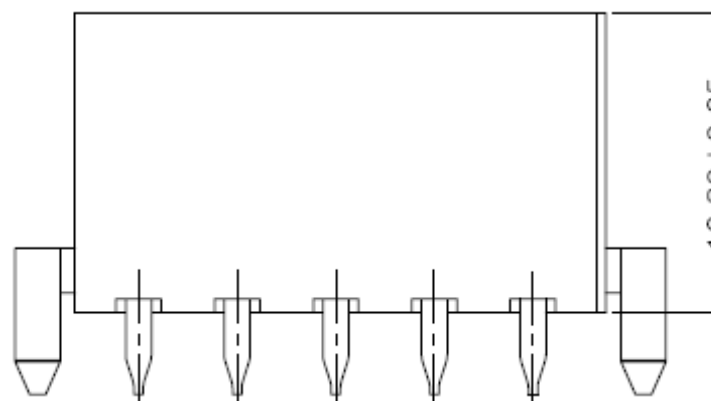
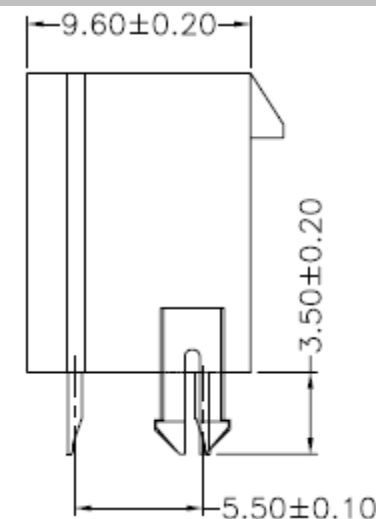
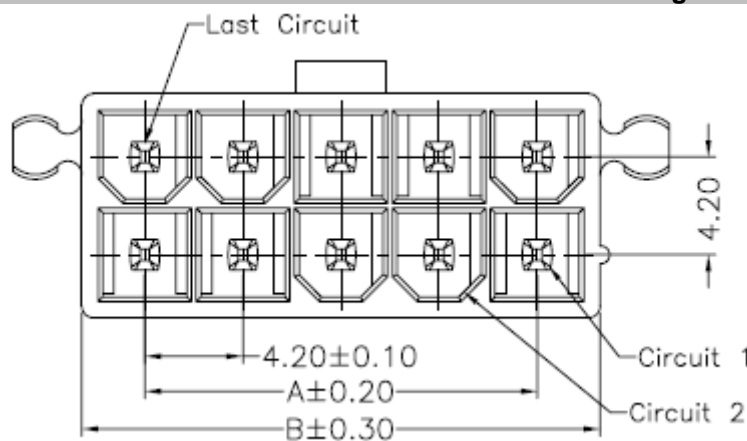

**MINI FIT CONNECTOR  
4,20mm**

Part No.: **T45007**

Customer:

DRW:	Jason	CHKD	Wilson	MATL:	Wilson	TOLERANCE	Mason	DATE	10.04.2009
APPD:	Schumi			FINISH	Jamy		Sheet No.		1 from 4

[www.edcon-components.com](http://www.edcon-components.com)

email: [info@edcon-components.com](mailto:info@edcon-components.com)



# EDCON-COMPONENTS

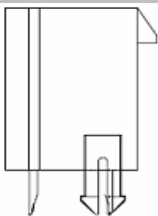

## Ordering Informations

Serie	No. of Pos.	Contact Plating	Plastic Material	Color	ROHS	Packing				
<b>T45007</b>	<b>XX</b>	<b>T0</b>	<b>HT</b>	<b>WH</b>	<b>R</b>	<b>BU</b>				

<b>XX</b> =2, 4, 6, 8, 10, 12, 14, 16, 18, 20, 22, 24	<b>T0</b> = Tin plated	<b>HT</b> = High Temperatur Plastic	<b>WH</b> = White	<b>N</b> =NO ROHS conform	<b>BU</b> = Bulk Ware (Standard)
				<b>R</b> =ROHS conform	
					<b>TU</b> = Tube Packing

**MINI FIT CONNECTOR  
4,20mm**

Part No.: **T45007**

DRW:	Jason	CHKD	Wilson	MATL:	Wilson	TOLERANCE	Mason	DATE	10.04.2009
APPD:	Schumi			FINISH	Jamy		Sheet No.		3 from 4

Customer:

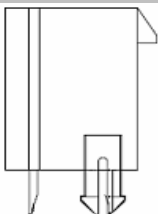

Soldering Profile for Lead Soldering ( P.B.T. )



Soldering Profile for Lead Free Soldering ( Nylon 6T )



**MINI FIT CONNECTOR  
4,20mm**

Part No.: **T45007**

DRW:	Jason	CHKD	Wilson	MATL:	Wilson	TOLERANCE	Mason	DATE	10.04.2009
APPD:	Schumi			FINISH	Jamy		Sheet No.	4 from 4	Customer: