

# EDCON-COMPONENTS

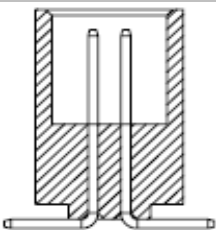

## Specifications

Current Rating: 1,0A  
 Insulation Resistance: 1000M Ohm min.  
 Contact Resistance: 30milli Ohm max.  
 Dielectric Voltage: 500V AC for one minute  
 Operating Temperature: -40°C ~ to +105°C  
 Insulator Material: PA6T+30% G.F.(UL94V-0)

Contact Pin: Brass  
 Contact Plating: Gold Flash all over

## PCB Layout



## Drawing

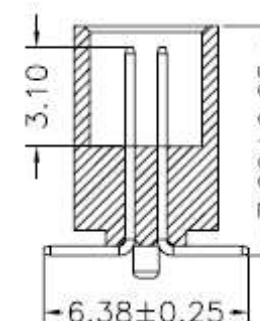
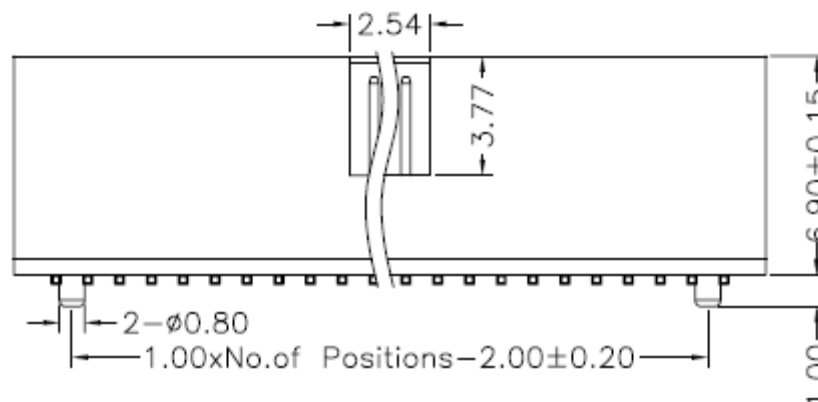
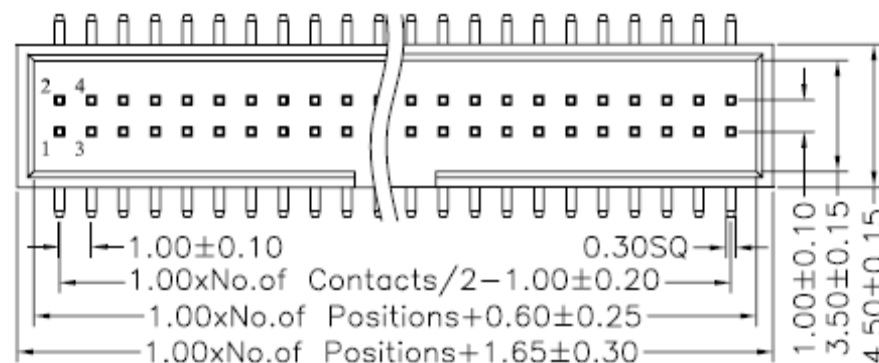
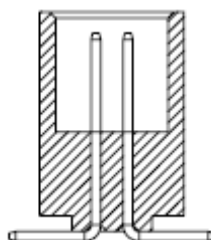

<b>Box Header Pitch 1,00x1,00mm</b>	
Part No.:	<b>T16E003</b>
Customer:	

DRW:	Jason	CHKD	Wilson	MATL:	Wilson	TOLERANCE	Mason	DATE	10.04.2009
APPD:	Schumi			FINISH	Jamy		Sheet No.	1 from 4	

# EDCON-COMPONENTS

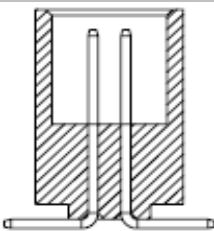

## Pin Code length table free configuration

Dimension ( mm)				
Pos.				
10				
20				
30				
40				
50				
60				

Dimension ( mm)				
Pos.				

Dimension ( mm)				
Pos.				

<b>Box Header Pitch 1,00x1,00mm</b>	
Part No.:	<b>T16E003</b>
Customer:	

DRW:	Jason	CHKD	Wilson	MATL:	Wilson	TOLERANCE	Mason	DATE	10.04.2009
APPD:	Schumi			FINISH	Jamy		Sheet No.		2 from 4

# EDCON-COMPONENTS

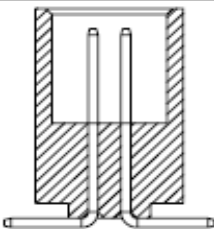

## Ordering Informations

Serie	No. of Pos.	Contact Plating	Material	Color of Body	ROHS	Packing				
<b>T16E003</b>	<b>XX</b>	<b>G0</b>	<b>PA</b>	<b>BK</b>	<b>R</b>	<b>BU</b>				

<b>XX</b> = total Pin	<b>G0</b> = Gold Flash	<b>PA</b> = PA6T +30% GF f. ROHS	<b>BK</b> = Black	<b>N</b> =NO ROHS conform	<b>BU</b> = Bulk Ware
	<b>T0</b> = Tin plated		<b>BL</b> = Blue		
	<b>GA</b> = 3µ Gold Plating		<b>WH</b> = White		<b>TY</b> = Tray Packing /Cap
	<b>GB</b> = 5µ Gold Plating				<b>TR</b> = Tape/Reel Cap
	<b>GC</b> = 10µ Gold Plating				
	<b>GD</b> = 30µ Gold Plating				
	<b>S0</b> = Selectiv Plating Gold Flash / Tin				
	<b>SD</b> = Selectiv Tin/ 5µGold				
<b>SD</b> = Selectiv Tin/ 10µ Gold Flash					
<b>SD</b> = Selectiv Tin/ 20µ Gold	<b>SD</b> = Selectiv Tin/ 30µ Gold				

<b>Box Header Pitch</b> <b>1,00x1,00mm</b>
Part No.: <b>T16E003</b>
Customer:

DRW:	Jason	CHKD	Wilson	MATL:	Wilson	TOLERANCE	Mason	DATE	10.04.2009
APPD:	Schumi			FINISH	Jamy		Sheet No.		3 from 4

# EDCON-COMPONENTS

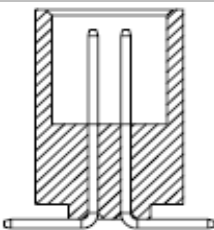

## Soldering Profile for Lead Soldering ( P.B.T. )

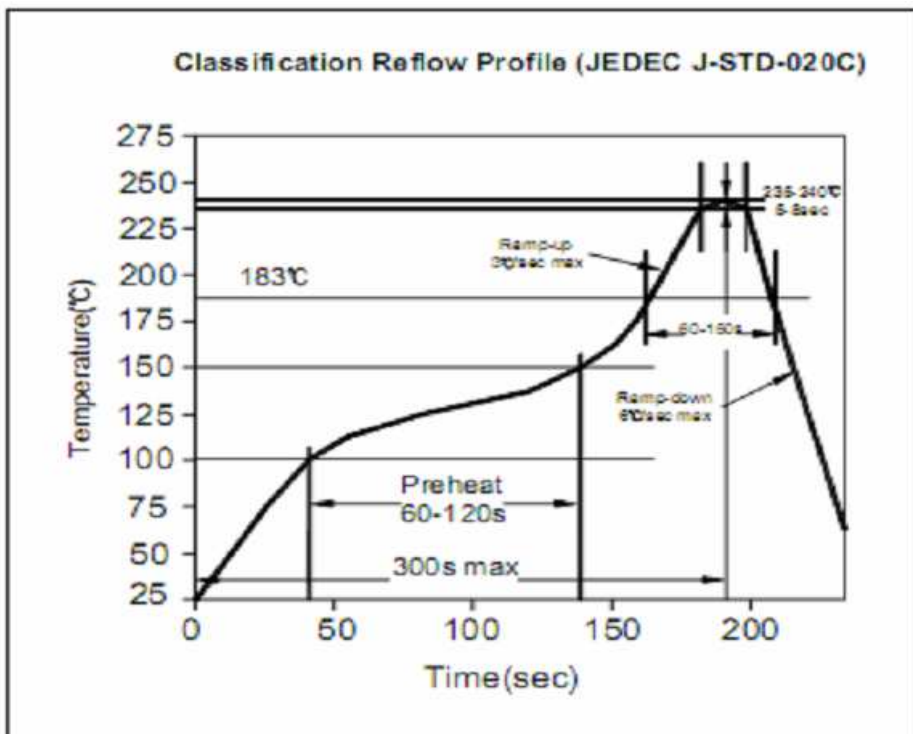

## Soldering Profile for Lead Free Soldering ( Nylon 6T )

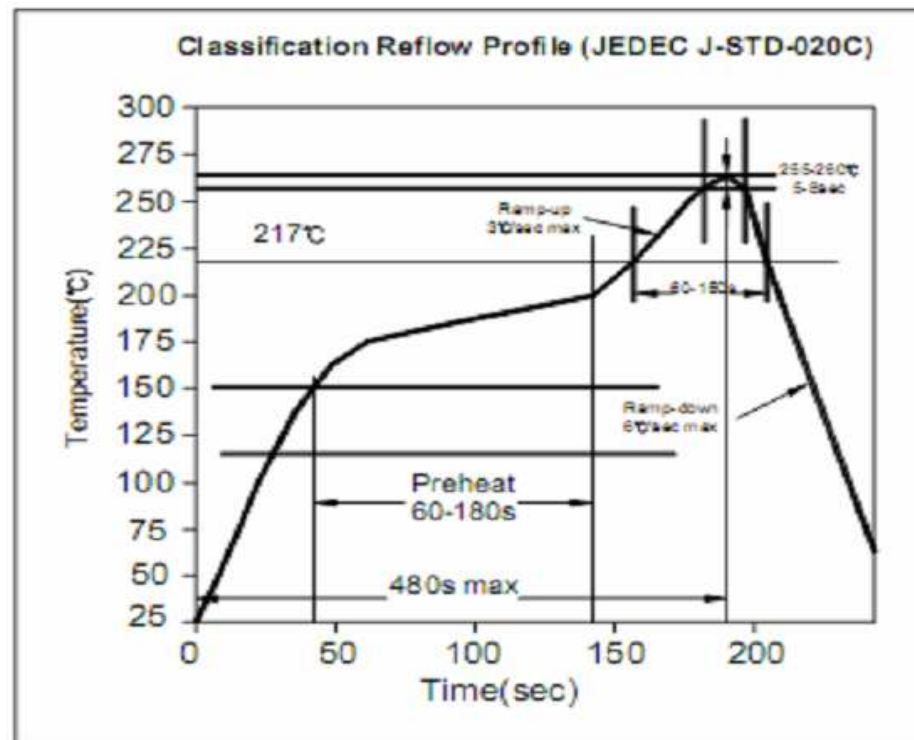

<b>Box Header Pitch 1,00x1,00mm</b>	
Part No.:	<b>T16E003</b>
Customer:	

DRW:	Jason	CHKD	Wilson	MATL:	Wilson	TOLERANCE	Mason	DATE	10.04.2009
APPD:	Schumi			FINISH	Jamy		Sheet No.	4 from 4	

[www.edcon-components.com](http://www.edcon-components.com)

email: info@edcon-components.com