

EDCON-COMPONENTS

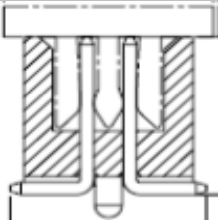

Specifications

Current Rating: 1,0A
 Insulation Resistance: 1000M Ohm min.
 Contact Resistance: 20milli Ohm max.
 Dielectric Voltage: 250V AC for one minute
 Operating Temperature: . -40°C ~ to +105°C
 Insulator Material: LCP +30% G.F.(UL94V-0)

Contact Pin: Phosphor Bronze
 Contact Plating: Gold Flash all over

PCB Layout

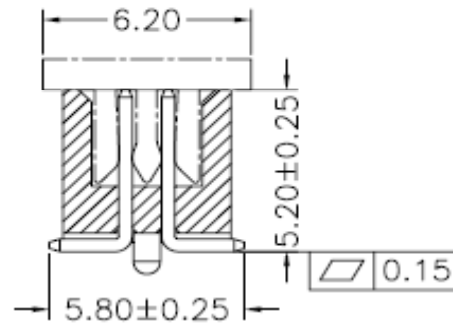
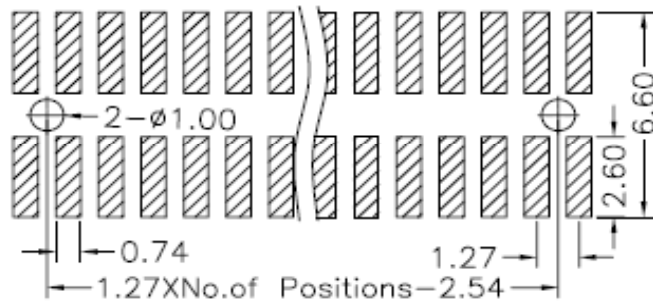

Drawing

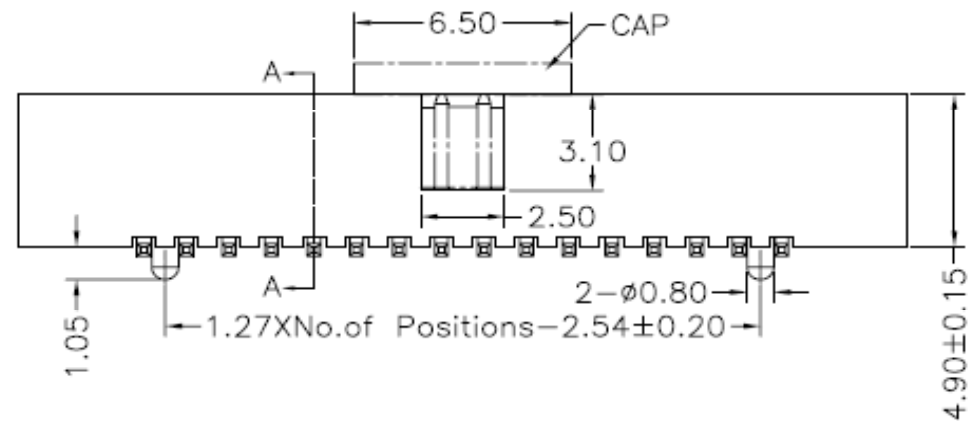
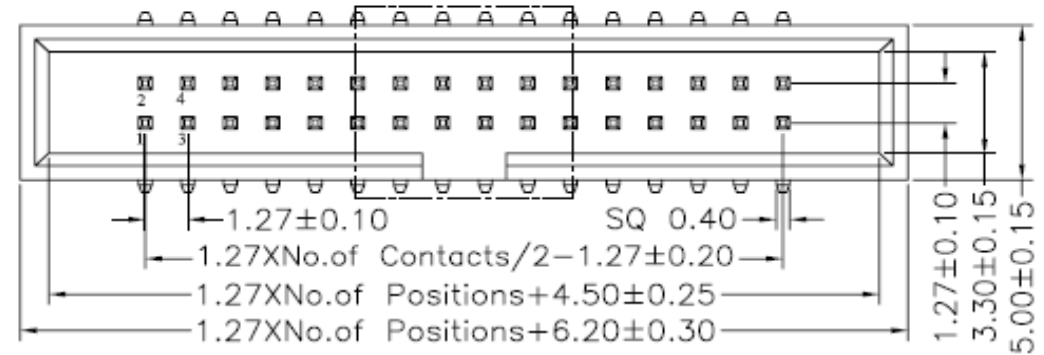

**Box Header Pitch
1,27x1,27mm**

Part No.: **T16C012-**

Customer:

| | | | | | | | | | |
|-------|--------|------|--------|--------|--------|-----------|-----------|----------|------------|
| DRW: | Jason | CHKD | Wilson | MATL: | Wilson | TOLERANCE | Mason | DATE | 27.01.2021 |
| APPD: | Schumi | | | FINISH | Jamy | | Sheet No. | 1 from 3 | |

www.edcon-components.com

email: info@edcon-components.com

EDCON-COMPONENTS

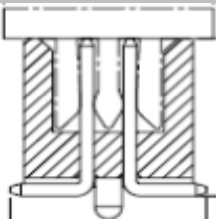

Ordering Informations

| Serie | No. of Pos. | Contact Plating | Material | Color of Body | ROHS | Packing | | | | |
|-----------------|-------------|-----------------|-----------|---------------|----------|-----------|--|--|--|--|
| T16C012- | XX | G0 | LC | BK | R | BU | | | | |

| | | | | | |
|--|---|------------------------------------|---|------------------------------|--|
| XX = 06,08, 10,12,14,16, 20,22,24,26, 30,34,40,44, 50,60,64,80, | G0 = Gold Flash | P6 = PA6T +30% GF | BK = Black | N =NO ROHS | BU = Bulk Ware |
| | T0 = Tin plated | | | | |
| | GA = 3µ Gold Plating | LC = LCP +30% GF | BL = Blue | TY = Tray Packing/Cap | |
| | GB = 5µ Gold Plating | WH = White | | | TR = Tape/Reel w. Pic and Place Cap |
| | GC = 10µ Gold Plating | | T0 = Tape/Reel without PIC and Place Cap | | |
| | GD = 30µ Gold Plating | | | | |
| | S0 = Selectiv Plating Gold Flash / Tin | | | | |
| | SD = Selectiv Tin/ 5µGold | | | | |
| | SD = Selectiv Tin/ 10µ Gold Flash | | | | |
| | SD = Selectiv Tin/ 20µ Gold | SD = Selectiv Tin/ 30µ Gold | | | |

| | |
|---|-----------------|
| Box Header Pitch 1,27x1,27mm | |
| Part No.: | T16C012- |
| Customer: | |

| | | | | | | | | | |
|-------|--------|------|--------|--------|--------|-----------|-----------|----------|------------|
| DRW: | Jason | CHKD | Wilson | MATL: | Wilson | TOLERANCE | Mason | DATE | 27.01.2021 |
| APPD: | Schumi | | | FINISH | Jamy | | Sheet No. | 3 from 3 | |

www.edcon-components.com

email: info@edcon-components.com

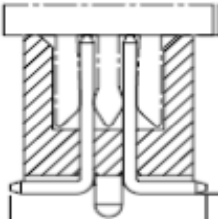

Soldering Profile for Lead Soldering (P.B.T.)

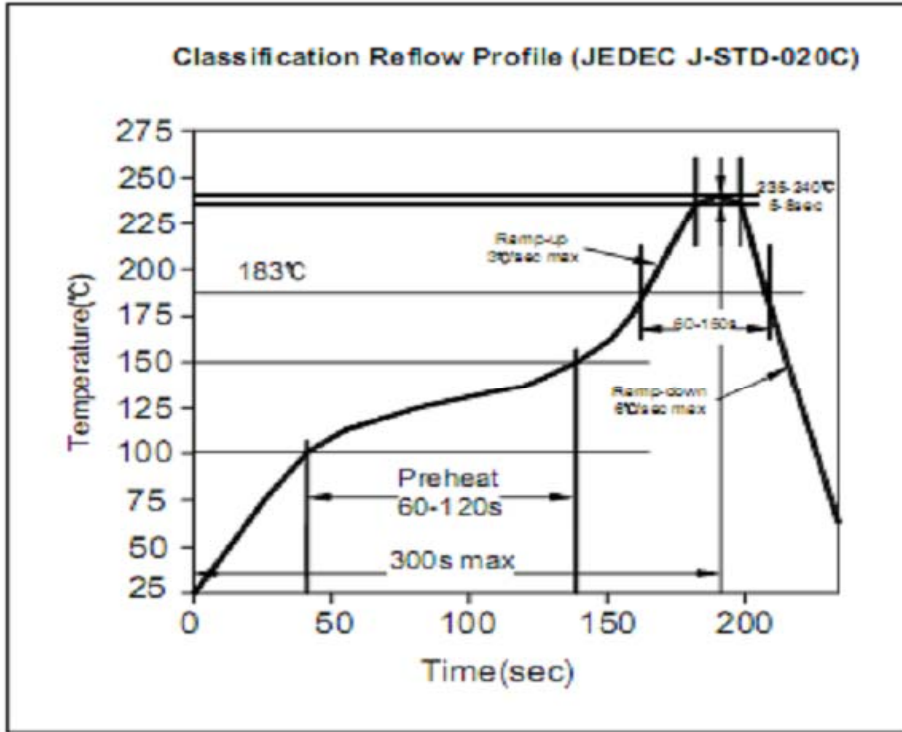

Soldering Profile for Lead Free Soldering (Nylon 6T)

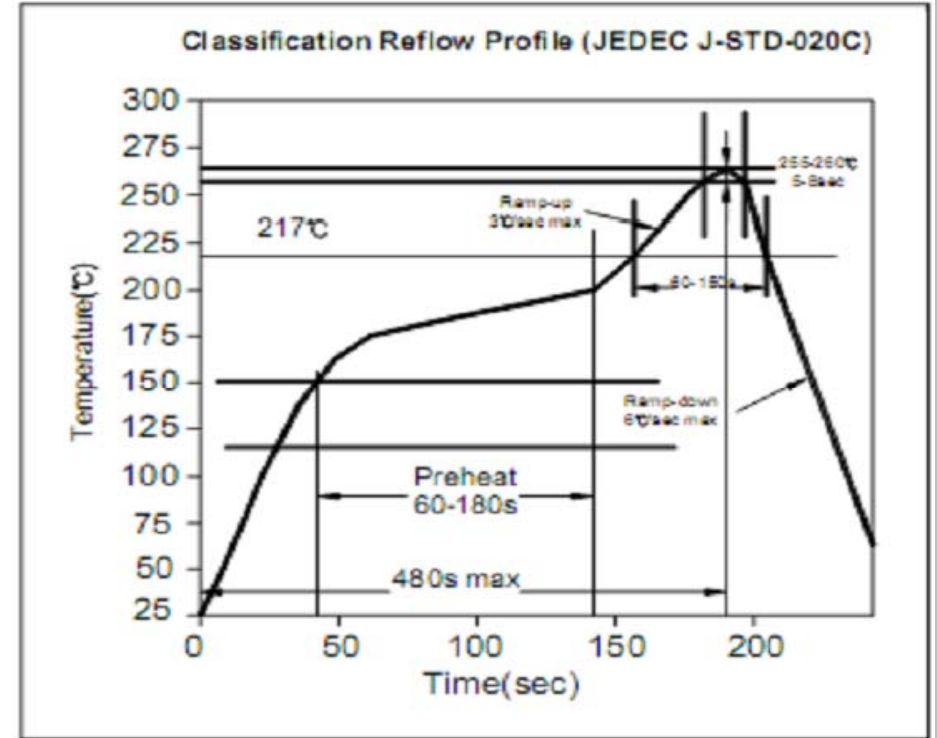

**Box Header Pitch
1,27x1,27mm**

Part No.: **T16C012-**

| | | | | | | | | | |
|-------|--------|------|--------|--------|--------|-----------|-----------|----------|------------|
| DRW: | Jason | CHKD | Wilson | MATL: | Wilson | TOLERANCE | Mason | DATE | 27.01.2021 |
| APPD: | Schumi | | | FINISH | Jamy | | Sheet No. | 3 from 3 | |

Customer:

www.edcon-components.com

email: info@edcon-components.com