

EDCON-COMPONENTS

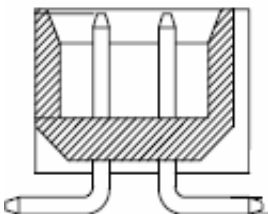

Specifications

Current Rating: 1,5A
 Insulation Resistance: 1000M Ohm min.
 Contact Resistance: 20milli Ohm max.
 Dielectric Voltage: 500V AC for one minute
 Operating Temperature: . -40°C ~ to +105°C
 Insulator Material: PBT/PA6T+30% G.F.(UL94V-0)

Contact Pin: Brass
 Contact Plating: Gold Flash all over

PCB Layout

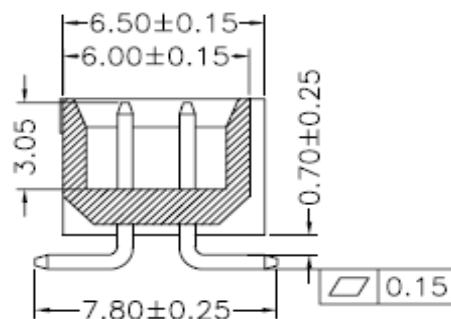
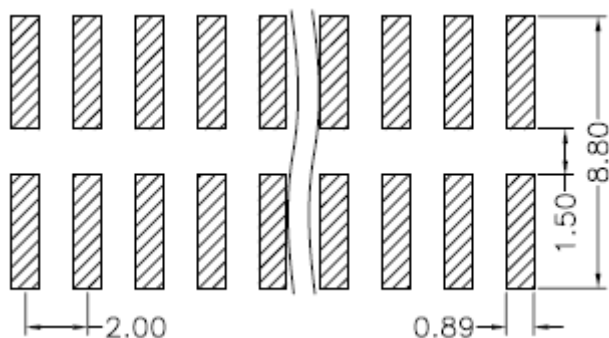

Drawing

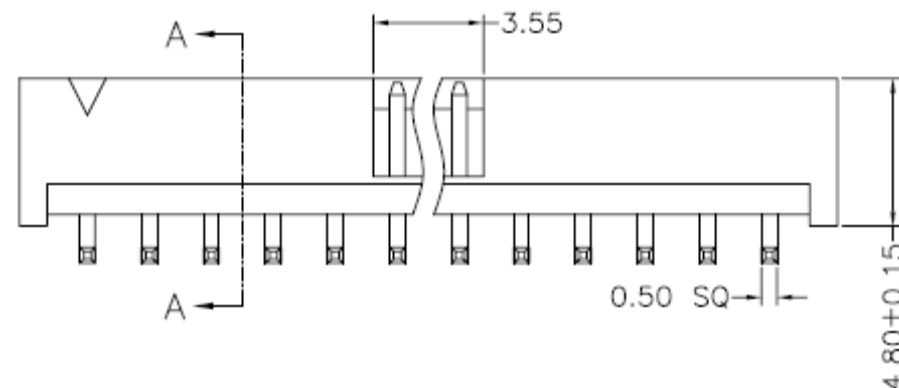
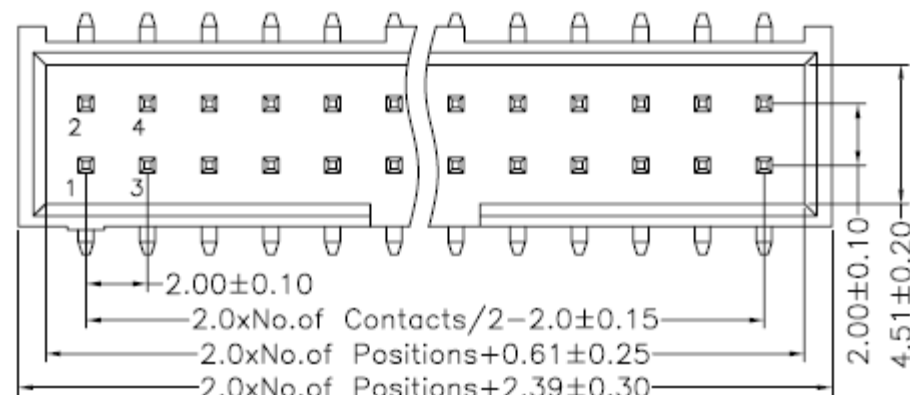

Box Header Pitch 2,00x2,00mm	
Part No.:	T16B025
Customer:	

DRW:	Jason	CHKD	Wilson	MATL:	Wilson	TOLERANCE	Mason	DATE	10.04.2009
APPD:	Schumi			FINISH	Jamy		Sheet No.	1 from 4	

EDCON-COMPONENTS

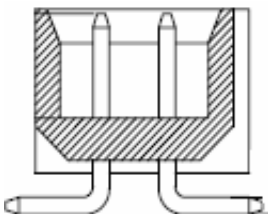

Pin Code length table free configuration

Dimension (mm)				
A00	Standard			
A01				
A02				
A03				
A04				
A05				
A06				
A07				
A08				
A09				
A10				
A11				
A12				
A13				
A14				
A15				
A16				
A17				
A18				
A19				
A20				
A21				
A22				

Dimension (mm)				
A23				
A24				
A25				
A26				
A27				
A28				
A29				
A30				
A31				
A32				
A33				
A34				
A35				
A36				
A37				
A38				
A39				
A40				
A41				
A42				
A43				
A44				

Dimension (mm)				
A45				
A46				
A47				
A48				
A49				
A50				
A51				
A52				
A53				
A54				
A55				
A56				
A57				
A58				
A59				
A60				
A61				
A62				
A64				
A65				
A66				

Box Header Pitch 2,00x2,00mm	
Part No.:	T16B025
Customer:	

DRW:	Jason	CHKD	Wilson	MATL:	Wilson	TOLERANCE	Mason	DATE	10.04.2009
APPD:	Schumi			FINISH	Jamy		Sheet No.		2 from 4

EDCON-COMPONENTS

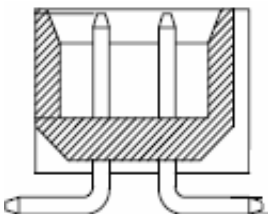

Ordering Informations

Serie	No. of Pos.	Contact Plating	Material	Color of Body	Pin Length Configuration	ROHS	Packing			
T16B025	XX	G0	LC	BK	A00	R	BU			

XX = 10, 14, 16, 20, 24, 26, 30, 34, 40, 44, 50, 60	G0 = Gold Flash	LC = LCP +30% GF f. ROHS	BK = Black BL = Blue WH = White	Axx = Look Table	N =NO ROHS conform R =ROHS conform	BU = Bulk Ware TU = Tube w. /CAP TY = Tray w. CAP TR = Tape/ Reel w.CAP
	T0 = Tin plated					
	GA = 3µ Gold Plating					
	GB = 5µ Gold Plating					
	GC = 10µ Gold Plating					
	GD = 30µ Gold Plating					
	S0 = Selectiv Plating Gold Flash / Tin					
SD = Selectiv Tin/ 5µGold						
SD = Selectiv Tin/ 10µ Gold Flash						
SD = Selectiv Tin/ 20µ Gold	SD = Selectiv Tin/ 30µ Gold					

Box Header Pitch 2,00x2,00mm
Part No.: T16B025
Customer:

DRW:	Jason	CHKD	Wilson	MATL:	Wilson	TOLERANCE	Mason	DATE	10.04.2009
APPD:	Schumi			FINISH	Jamy		Sheet No.		3 from 4

www.edcon-components.com

email: info@edcon-components.com

EDCON-COMPONENTS

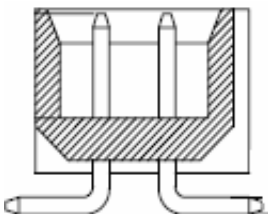

Soldering Profile for Lead Soldering (P.B.T.)



Soldering Profile for Lead Free Soldering (Nylon 6T)



Box Header Pitch 2,00x2,00mm	
Part No.:	T16B025
Customer:	

DRW:	Jason	CHKD	Wilson	MATL:	Wilson	TOLERANCE	Mason	DATE	10.04.2009
APPD:	Schumi			FINISH	Jamy		Sheet No.	4 from 4	

www.edcon-components.com

email: info@edcon-components.com