

# EDCON-COMPONENTS

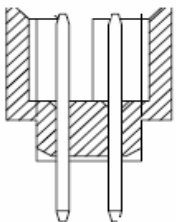

## Specifications

Current Rating: 1,5A  
 Insulation Resistance: 1000M Ohm min.  
 Contact Resistance: 20milli Ohm max.  
 Dielectric Voltage: 500V AC for one minute  
 Operating Temperature: -40°C ~ to +105°C  
 Insulator Material: PBT/PA6T+30% G.F.(UL94V-0)

Contact Pin: Brass  
 Contact Plating: Gold Flash all over

## PCB Layout

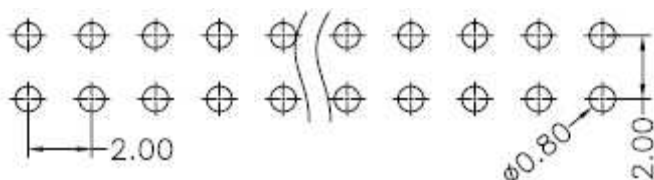

## Drawing

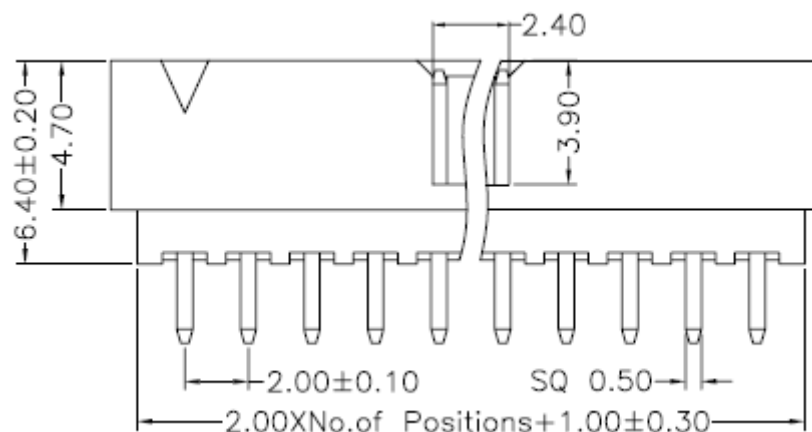
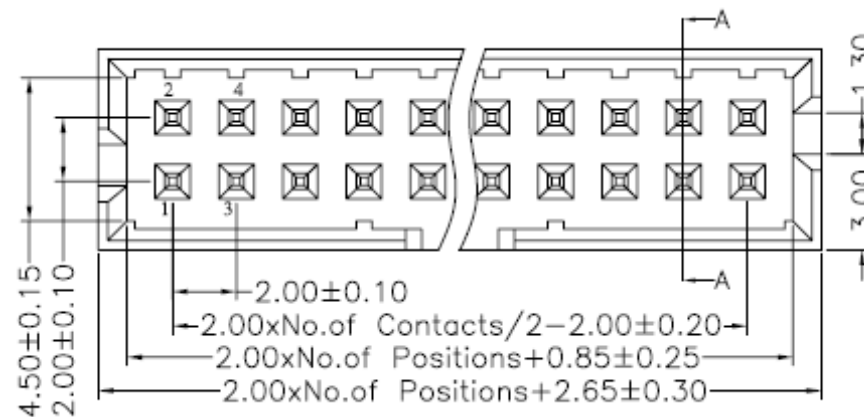
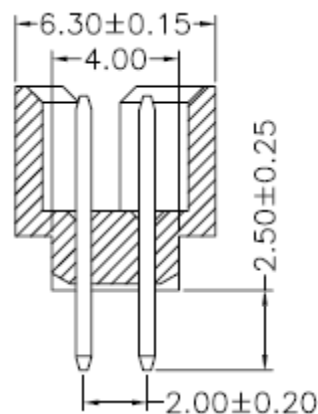

<b>Box Header Pitch 2,00x2,00mm</b>	
Part No.:	<b>T16B012</b>
Customer:	

DRW:	Jason	CHKD	Wilson	MATL:	Wilson	TOLERANCE	Mason	DATE	10.04.2009
APPD:	Schumi			FINISH	Jamy		Sheet No.		1 from 4

# EDCON-COMPONENTS

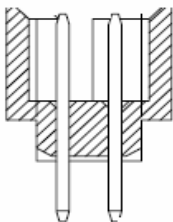

## Pin Code length table free configuration

Dimension ( mm)				
	A			
A01	2,50			
A02				
A03				
A04				
A05				
A06				
A07				
A08				
A09				
A10				
A11				
A12				
A13				
A14				
A15				
A16				
A17				
A18				
A19				
A20				
A21				
A22				

Dimension ( mm)				
	A			
A23				
A24				
A25				
A26				
A27				
A28				
A29				
A30				
A31				
A32				
A33				
A34				
A35				
A36				
A37				
A38				
A39				
A40				
A41				
A42				
A43				
A44				

Dimension ( mm)				
	A			
A45				
A46				
A47				
A48				
A49				
A50				
A51				
A52				
A53				
A54				
A55				
A56				
A57				
A58				
A59				
A60				
A61				
A62				
A63				
A64				
A65				
A66				

<b>Box Header Pitch 2,00x2,00mm</b>	
Part No.:	<b>T16B012</b>
Customer:	

DRW:	Jason	CHKD	Wilson	MATL:	Wilson	TOLERANCE	Mason	DATE	10.04.2009
APPD:	Schumi			FINISH	Jamy		Sheet No.		2 from 4

# EDCON-COMPONENTS

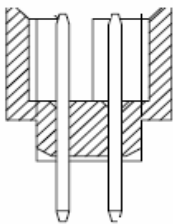

## Ordering Informations

Serie	No. of Pos.	Contact Plating	Material	Color of Body	Pin Length Configuration	ROHS	Packing			
<b>T16B012</b>	<b>XX</b>	<b>G0</b>	<b>LC</b>	<b>BK</b>	<b>A01</b>	<b>R</b>	<b>BU</b>			

<b>XX=</b> 10, 14, 16, 20, 24, 26, 30, 34, 40, 44, 50, 60	<b>G0=</b> Gold Flash	<b>LC=</b> LCP +30% GF f. ROHS	<b>BK=</b> Black	<b>Axx=</b> Look Table	<b>N=</b> NO ROHS conform <b>R=</b> ROHS conform	<b>BU=</b> Bulk Ware
	<b>T0=</b> Tin plated		<b>BL=</b> Blue			<b>TU=</b> Tube Packing
	<b>GA=</b> 3µ Gold Plating		<b>WH=</b> White		<b>TY=</b> Tray Packing	
	<b>GB=</b> 5µ Gold Plating					
	<b>GC=</b> 10µ Gold Plating					
	<b>GD=</b> 30µ Gold Plating					
	<b>S0=</b> Selectiv Plating Gold Flash / Tin					
	<b>SD=</b> Selectiv Tin/ 5µGold					
<b>SD=</b> Selectiv Tin/ 10µ Gold Flash						
<b>SD=</b> Selectiv Tin/ 20µ Gold	<b>SD=</b> Selectiv Tin/ 30µ Gold					

<b>Box Header Pitch</b> <b>2,00x2,00mm</b>
Part No.: <b>T16B012</b>
Customer:

DRW:	Jason	CHKD	Wilson	MATL:	Wilson	TOLERANCE	Mason	DATE	10.04.2009
APPD:	Schumi			FINISH	Jamy		Sheet No.		3 from 4

[www.edcon-components.com](http://www.edcon-components.com)

email: [info@edcon-components.com](mailto:info@edcon-components.com)

# EDCON-COMPONENTS

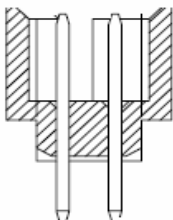

## Soldering Profile for Lead Soldering ( P.B.T. )

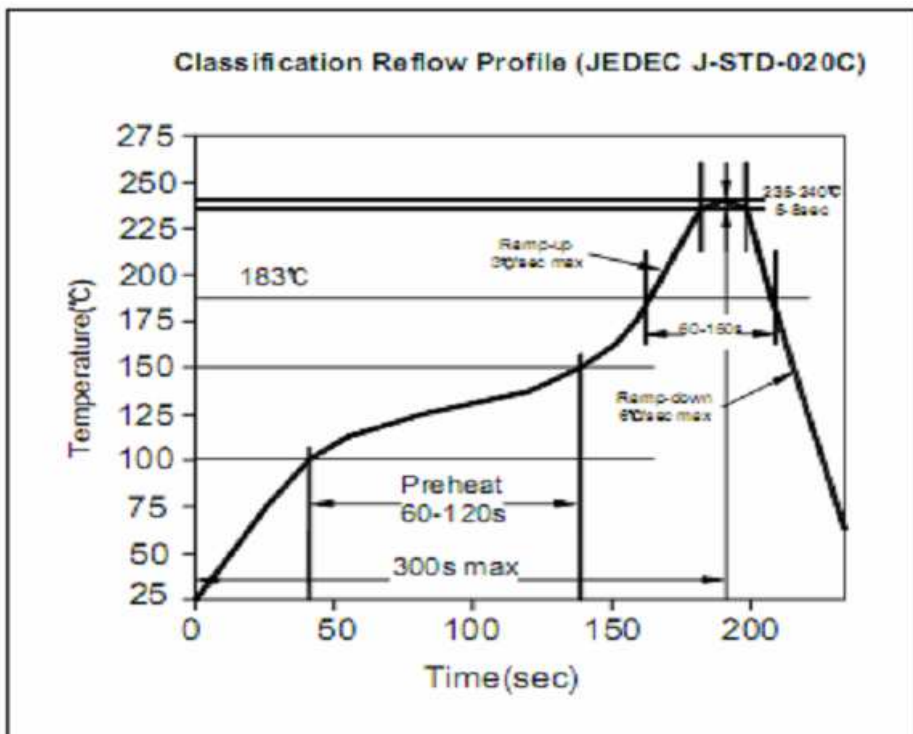

## Soldering Profile for Lead Free Soldering ( Nylon 6T )

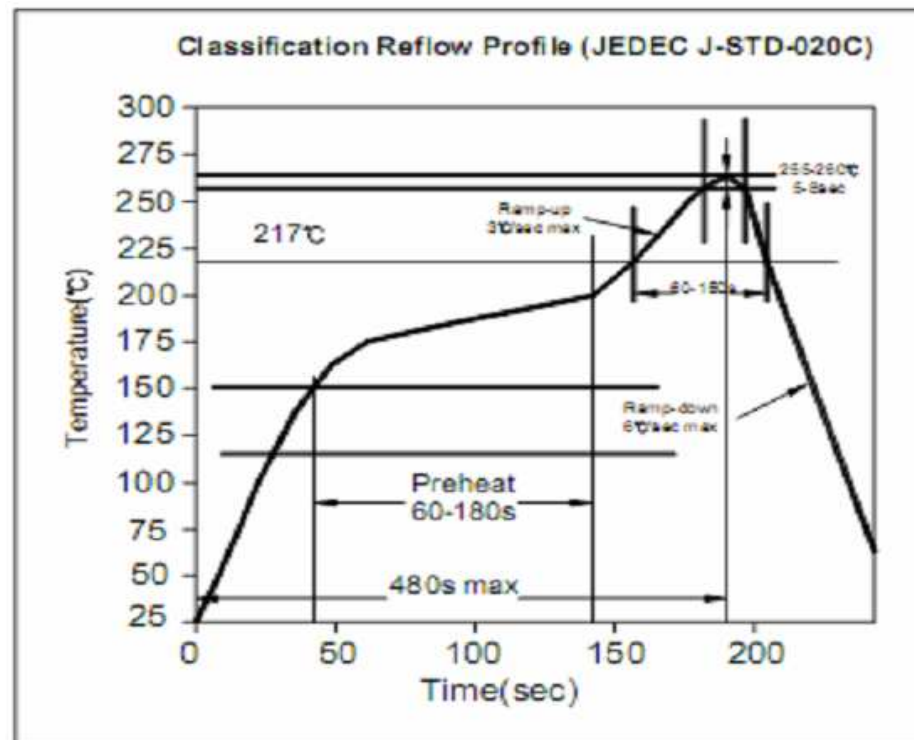

<b>Box Header Pitch 2,00x2,00mm</b>	
Part No.:	<b>T16B012</b>
Customer:	

DRW:	Jason	CHKD	Wilson	MATL:	Wilson	TOLERANCE	Mason	DATE	10.04.2009
APPD:	Schumi			FINISH	Jamy		Sheet No.	4 from 4	

[www.edcon-components.com](http://www.edcon-components.com)

email: info@edcon-components.com