

EDCON-COMPONENTS

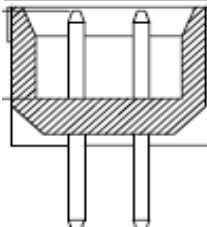

Specifications

Current Rating: 1,5A
 Insulation Resistance: 1000M Ohm min.
 Contact Resistance: 20milli Ohm max.
 Dielectric Voltage: 500V AC for one minute
 Operating Temperature: -40°C ~ to +105°C
 Insulator Material: PBT/PA6T+30% G.F.(UL94V-0)

Contact Pin: Brass
 Contact Plating: Gold Flash all over

PCB Layout

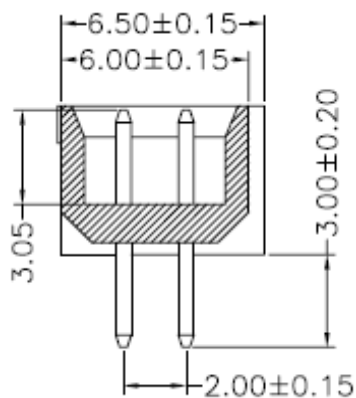
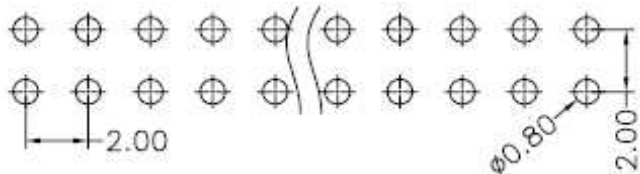

Drawing

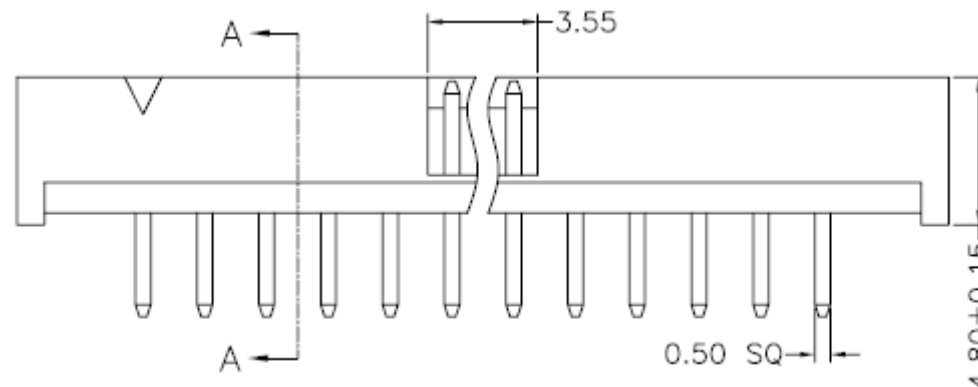
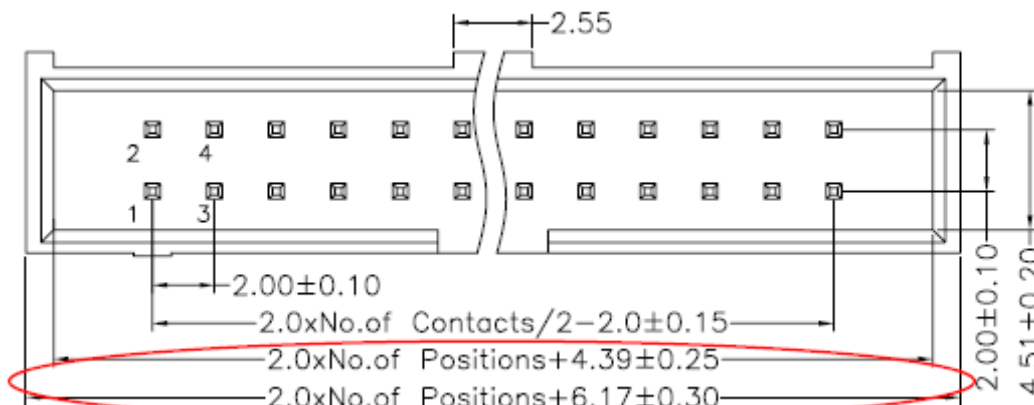

Box Header Pitch	
2,54x2,54mm	
Part No.:	T16B001
Customer:	

DRW:	Jason	CHKD	Wilson	MATL:	Wilson	TOLERANCE	Mason	DATE	10.04.2009
APPD:	Schumi			FINISH	Jamy		Sheet No.	1 from 4	

EDCON-COMPONENTS

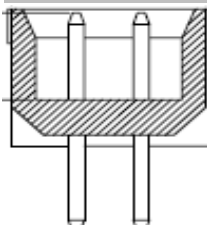

Pin Code length table free configuration

Dimension (mm)				
	A			
A01	2,80			
A02				
A03				
A04				
A05				
A06				
A07				
A08				
A09				
A10				
A11				
A12				
A13				
A14				
A15				
A16				
A17				
A18				
A19				
A20				
A21				
A22				

Dimension (mm)				
	A			
A23				
A24				
A25				
A26				
A27				
A28				
A29				
A30				
A31				
A32				
A33				
A34				
A35				
A36				
A37				
A38				
A39				
A40				
A41				
A42				
A43				
A44				

Dimension (mm)				
	A			
A45				
A46				
A47				
A48				
A49				
A50				
A51				
A52				
A53				
A54				
A55				
A56				
A57				
A58				
A59				
A60				
A61				
A62				
A63				
A64				
A65				
A66				

Box Header Pitch 2,54x2,54mm	
Part No.:	T16B001
Customer:	

DRW:	Jason	CHKD	Wilson	MATL:	Wilson	TOLERANCE	Mason	DATE	10.04.2009
APPD:	Schumi			FINISH	Jamy		Sheet No.		2 from 4

EDCON-COMPONENTS

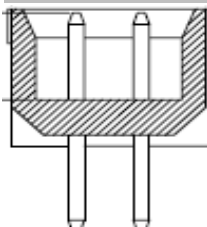

Ordering Informations

Serie	No. of Pos.	Contact Plating	Material	Color of Body	Pin Length Configuration	ROHS	Packing			
T16B001	XX	G0	LC	BK	A01	R	BU			

XX = total Pin	G0 = Gold Flash	LC = LCP +30% GF f. ROHS	BK = Black	Axx = Look Table	N =NO ROHS conform	BU = Bulk Ware
	T0 = Tin plated		BL = Blue		R =ROHS conform	TU = Tube Packing
	GA = 3µ Gold Plating		GR = Gray (427°C)		TY = Tray Packing	
	GB = 5µ Gold Plating		EG = Gray (413°C)			
	GC = 10µ Gold Plating					
	GD = 30µ Gold Plating					
	S0 = Selectiv Plating Gold Flash / Tin					
	SD = Selectiv Tin/ 5µGold					
SD = Selectiv Tin/ 10µ Gold Flash						
SD = Selectiv Tin/ 20µ Gold	SD = Selectiv Tin/ 30µ Gold					

Box Header Pitch 2,54x2,54mm
Part No.: T16B001
Customer:

DRW:	Jason	CHKD	Wilson	MATL:	Wilson	TOLERANCE	Mason	DATE	10.04.2009
APPD:	Schumi			FINISH	Jamy		Sheet No.		3 from 4

EDCON-COMPONENTS

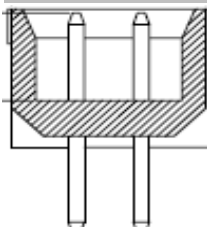

Soldering Profile for Lead Soldering (P.B.T.)



Soldering Profile for Lead Free Soldering (Nylon 6T)



Box Header Pitch	
2,54x2,54mm	
Part No.:	T16B001
Customer:	

DRW:	Jason	CHKD	Wilson	MATL:	Wilson	TOLERANCE	Mason	DATE	10.04.2009
APPD:	Schumi			FINISH	Jamy		Sheet No.	4 from 4	