

EDCON-COMPONENTS

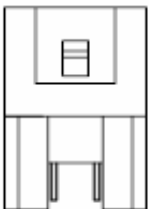

Specifications

Current Rating: 3,0A
 Insulation Resistance: 1000M Ohm min.
 Contact Resistance: 20milli Ohm max.
 Dielectric Voltage: 500V AC for one minute
 Operating Temperature: -40°C ~ to +105°C
 Insulator Material: PBT/PA6T+30% G.F.(UL94V-0)

Contact Pin: Brass
 Contact Plating: Gold Flash all over

Drawing

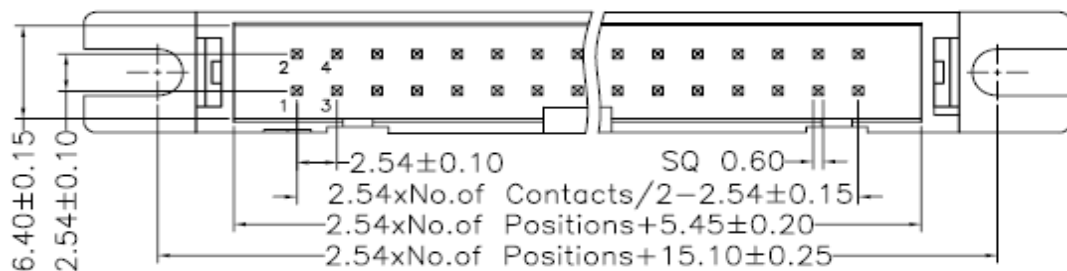
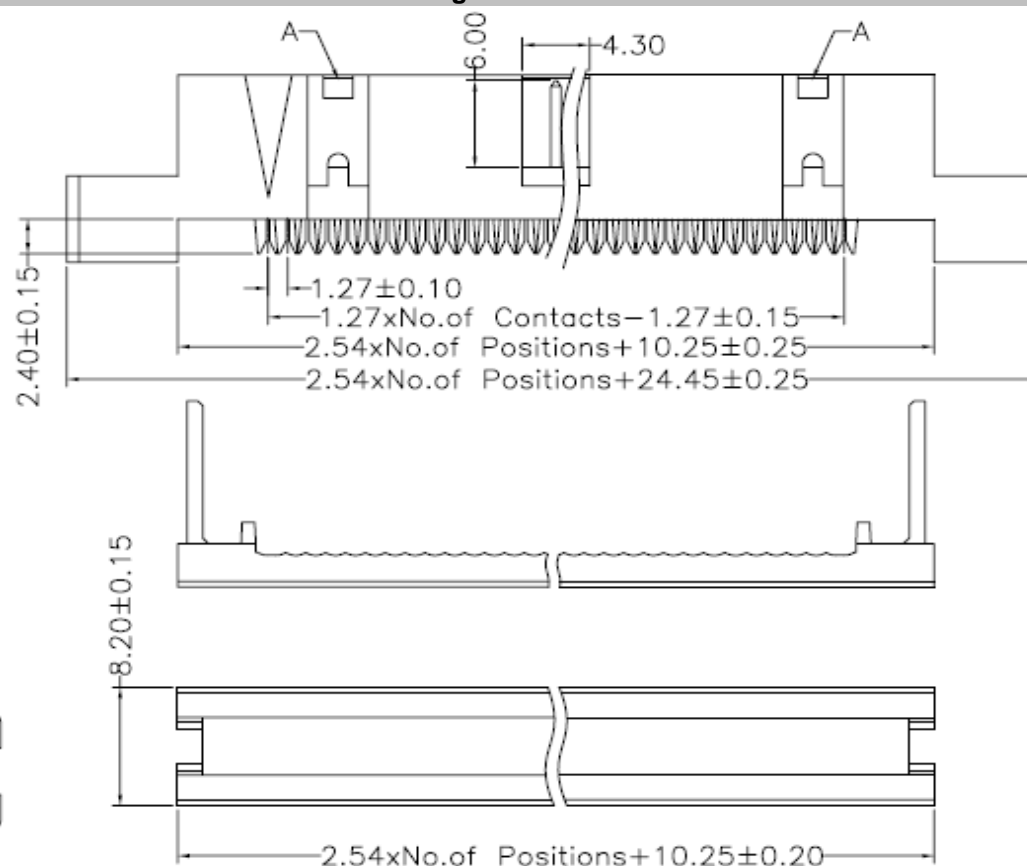
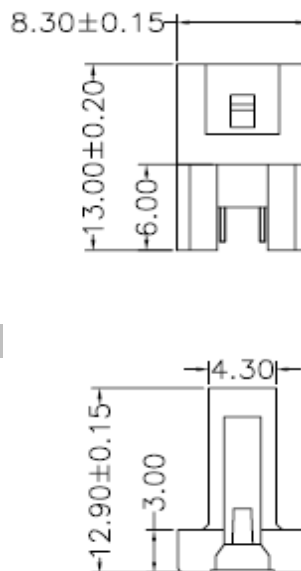

Box Header Pitch	
2,54x2,54mm	
Part No.:	T16A017
Customer:	

DRW:	Jason	CHKD	Wilson	MATL:	Wilson	TOLERANCE	Mason	DATE	10.04.2009
APPD:	Schumi			FINISH	Jamy		Sheet No.	1 from 4	

EDCON-COMPONENTS

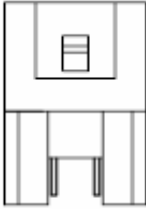

Pin Code length table free configuration

Dimension (mm)			
A00	Standard		
A01			
A02			
A03			
A04			
A05			
A06			
A07			
A08			
A09			
A10			
A11			
A12			
A13			
A14			
A15			
A16			
A17			
A18			
A19			
A20			
A21			
A22			

Dimension (mm)				

Dimension (mm)				

Box Header Pitch 2,54x2,54mm
Part No.: T16A017
Customer:

DRW:	Jason	CHKD	Wilson	MATL:	Wilson	TOLERANCE	Mason	DATE	10.04.2009
APPD:	Schumi			FINISH	Jamy			Sheet No.	2 from 4

EDCON-COMPONENTS

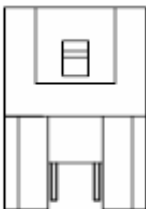

Ordering Informations

Serie	No. of Pos.	Contact Plating	Material	Color of Body	Pin Length Configuration	ROHS	Packing			
T16A017	XX	G0	PB	BK	A00	R	BU			

XX= 10, 14, 16, 20, 24, 26, 30, 34, 40, 50, 60, 64	G0= Gold Flash	PB= PBT	BK= Black	Axx = Look Table	N= NO ROHS conform	BU= Bulk Ware
	T0= Tin plated	PA= PA6T +30% GF f. ROHS	GR= Gray (427°C)			R= ROHS conform
	GA= 3µ Gold Plating		EG= Gray (413°C)			TC= Tube w. CAP
	GB= 5µ Gold Plating					TY= Tray w.CAP
	GC= 10µ Gold Plating					
	GD= 30µ Gold Plating					
	S0= Selectiv Plating Gold Flash / Tin					
	SD= Selectiv Tin/ 5µGold					
SD= Selectiv Tin/ 10µ Gold Flash						
SD= Selectiv Tin/ 20µ Gold	SD= Selectiv Tin/ 30µ Gold					

Box Header Pitch 2,54x2,54mm
Part No.: T16A017
Customer:

DRW:	Jason	CHKD	Wilson	MATL:	Wilson	TOLERANCE	Mason	DATE	10.04.2009
APPD:	Schumi			FINISH	Jamy		Sheet No.		3 from 4

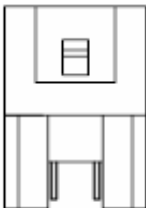

Soldering Profile for Lead Soldering (P.B.T.)

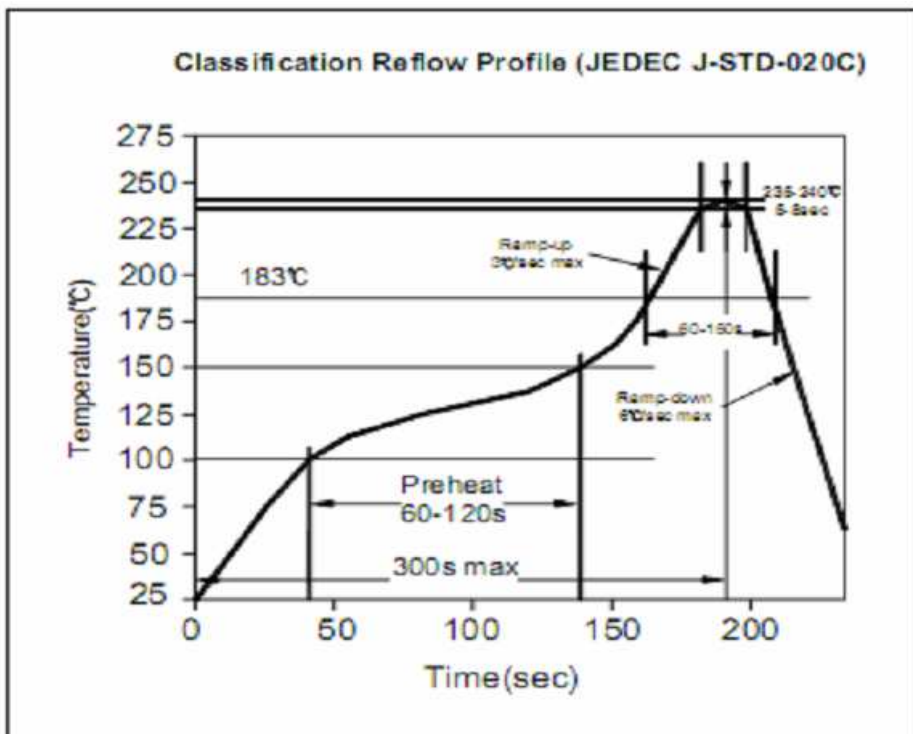

Soldering Profile for Lead Free Soldering (Nylon 6T)

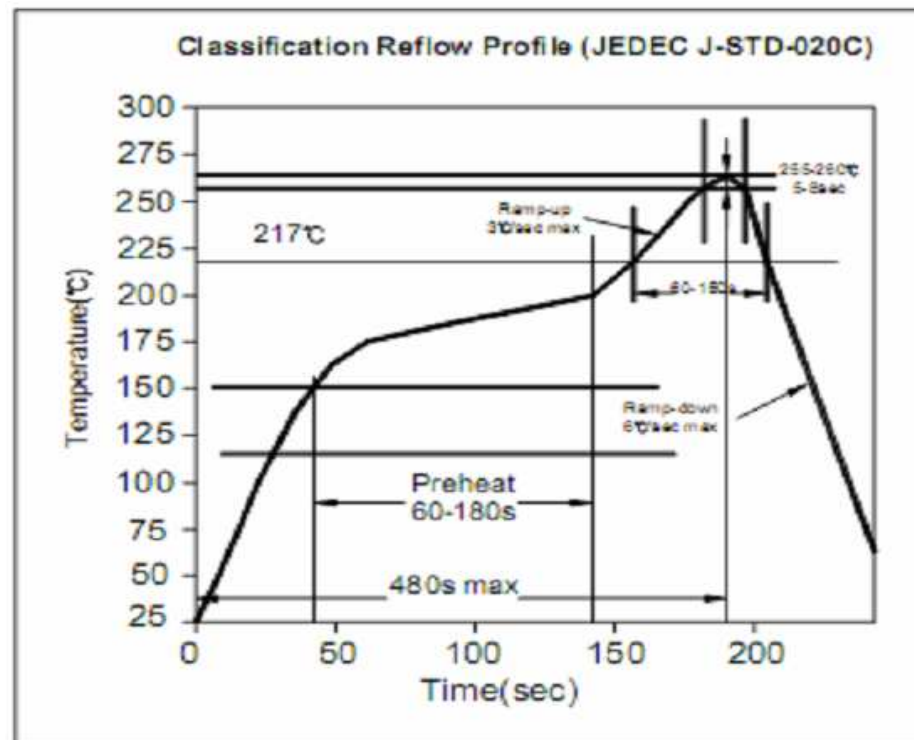

Box Header Pitch 2,54x2,54mm	
Part No.:	T16A017
Customer:	

DRW:	Jason	CHKD	Wilson	MATL:	Wilson	TOLERANCE	Mason	DATE	10.04.2009
APPD:	Schumi			FINISH	Jamy		Sheet No.	4 from 4	