

DATA SHEET

SMC-Connector Male Q Type H= 9,9mm

Serie: T15G009

SMC-Connector Male	Q
Type H= 9,9mm	

Serie No.:	T15G009
------------	----------------

DRW:	Jason	CHKD	Wilson	MATL:	Wilson	TOLERANCE	Mason	DATE	12.09.2018	Customer:
APPD:	Schumi			FINISH	Jamy		Sheet No.	1 from 5		

EDCON-COMPONENTS

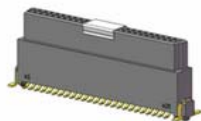

Technical Informations

Rated Current: 0,5A
 Contact Resistance: 25mΩ Max.
 Withstanding Voltage: 500V
 Insulation Resistance: 10000MΩ Min.
 Operating Temperature: -55°C to + 125°C

Contact Material: Phosphor Bronze
 Contact Plating: Sn and Au over Ni
 Tail Material: Phosphor Bronze
 Tail Plating: Sn over Ni
 Main Body Material: LCP

Technical Dimensions (mm)

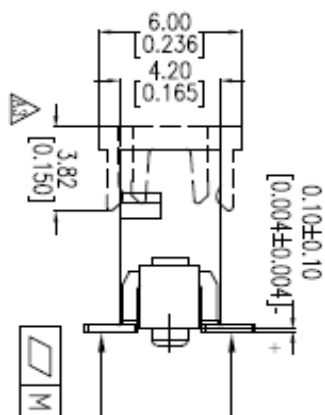
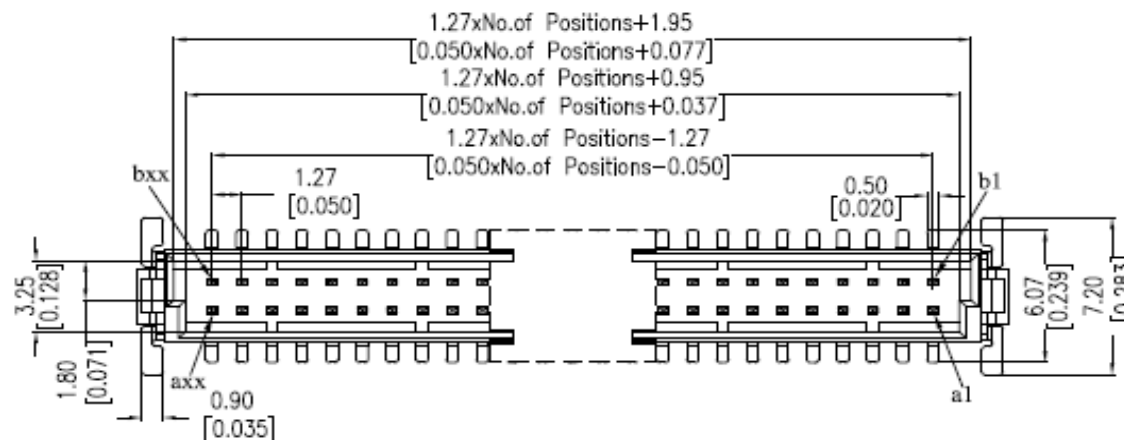

Pin	A	B	C	D	E
10	5,08	9,50	11,43	8,10	7,10
20	11,43	15,85	17,78	14,45	13,45
30	17,78	22,20	24,13	20,80	19,80
40	24,13	28,55	30,48	27,15	26,15
50	30,48	34,90	36,83	33,50	32,50
60	36,83	41,25	43,18	39,85	38,85
70	43,18	47,60	49,53	46,20	45,20
80	49,53	53,95	55,88	52,55	51,55
90	55,88	60,30	62,23	58,90	57,90
100	62,23	66,65	68,58	65,25	64,25

Tolerances unless otherwise specified (mm)

X	X.X	X.XX	X.XXX	Angle
±	±	±	±	±3°

SMC-Connector Male Q
Type H= 9,9mm

Part No.: **T15G009**

Customer:

DRW:	Jason	CHKD	Wilson	MATL:	Wilson	TOLERANCE	Mason	DATE	12.09.2018
APPD:	Schumi			FINISH	Jamy		Sheet No.		2 from 5

EDCON-COMPONENTS

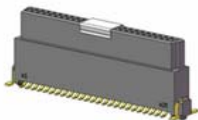

PCB Layout (Top-Side) Tol. ± 0,05mm

Technical Dimension (mm)

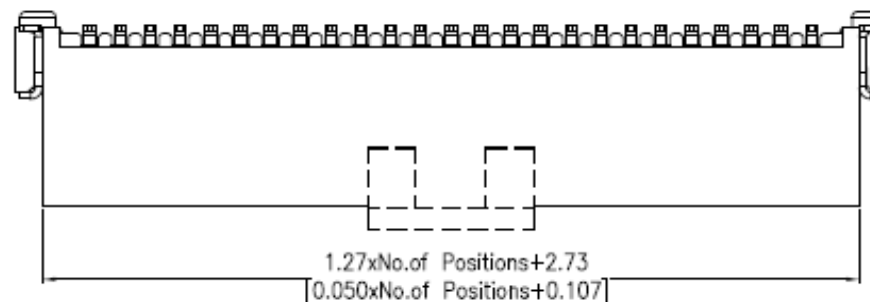
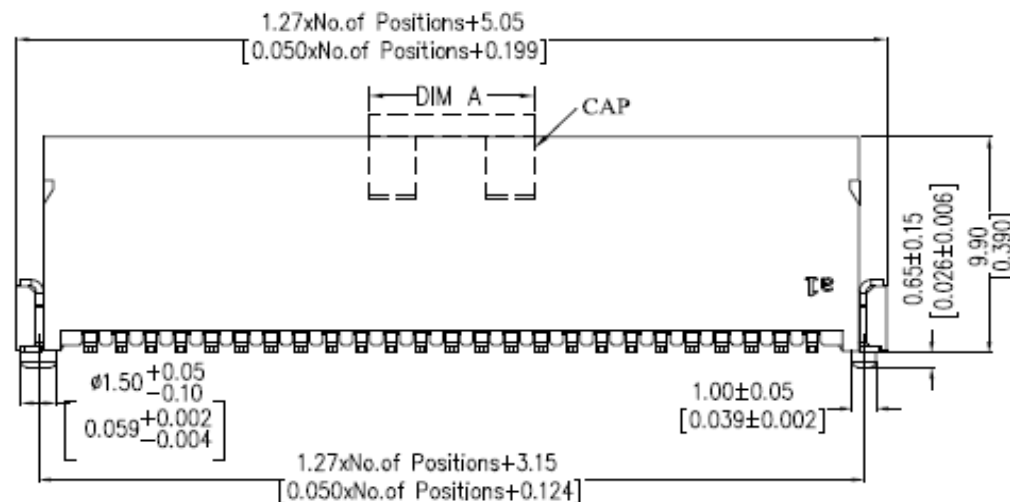
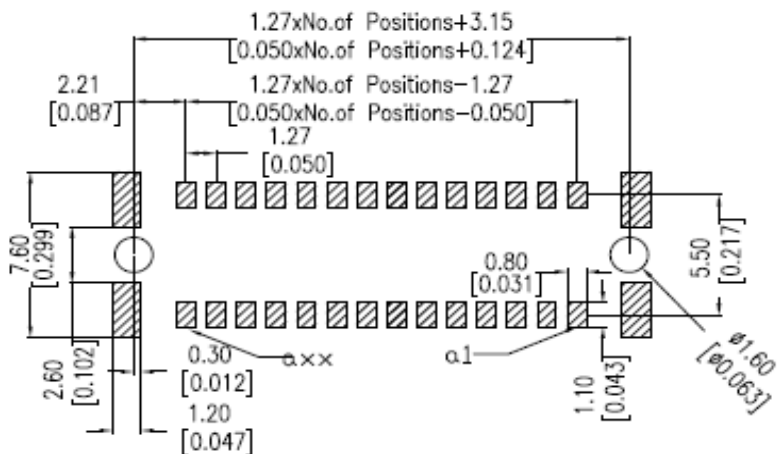

SMC-Connector Male Q
Type H= 9,9mm

Part No.: **T15G009**

Customer:

DRW:	Jason	CHKD	Wilson	MATL:	Wilson	TOLERANCE	Mason	DATE	12.09.2018
APPD:	Schumi			FINISH	Jamy		Sheet No.		3 from 5

EDCON-COMPONENTS

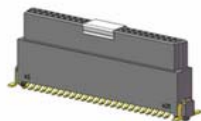

Ordering Informations

Serie	No of Pin	Height (mm)	Contact Type	Contact Plating	Special function	Special function	Special function	ROHS	Packing Code	
T15G009	010	990	M	S0	N	N	N	R	TR	
	010= 10Pos.	990= 9,9mm	M= Male	S0= Selectiv Gold flash	N= No function	N= No function	N= No function	R= ROHS Conform	TC= TUBE Packing w. PIC and Place CAP	
	xxx= like Pos. table			S1= Selectiv 3μ AU / Tin				N= NON ROHS Conform		
				S2= Selectiv 5μ AU / Tin					TR= Tape Reel Packing w. Pic and Place Cap	
				S3= Selectiv 10μ AU / Tin						
				S4= Selectiv 15μ AU / Tin						
				S5= Selectiv 30μ AU / Tin						

SMC-Connector Male Q
Type H= 9,9mm

Part No.: **T15G009**

DRW:	Jason	CHKD	Wilson	MATL:	Wilson	TOLERANCE	Mason	DATE	12.09.2018	Customer:
------	-------	------	--------	-------	--------	-----------	-------	------	------------	-----------

Copyright by S.Tiede
EDCON-COMPONENTS

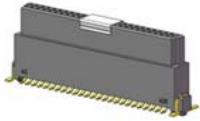

Soldering Profile Curve

Classification Reflow Profile (JEDEC J-STD-020C)

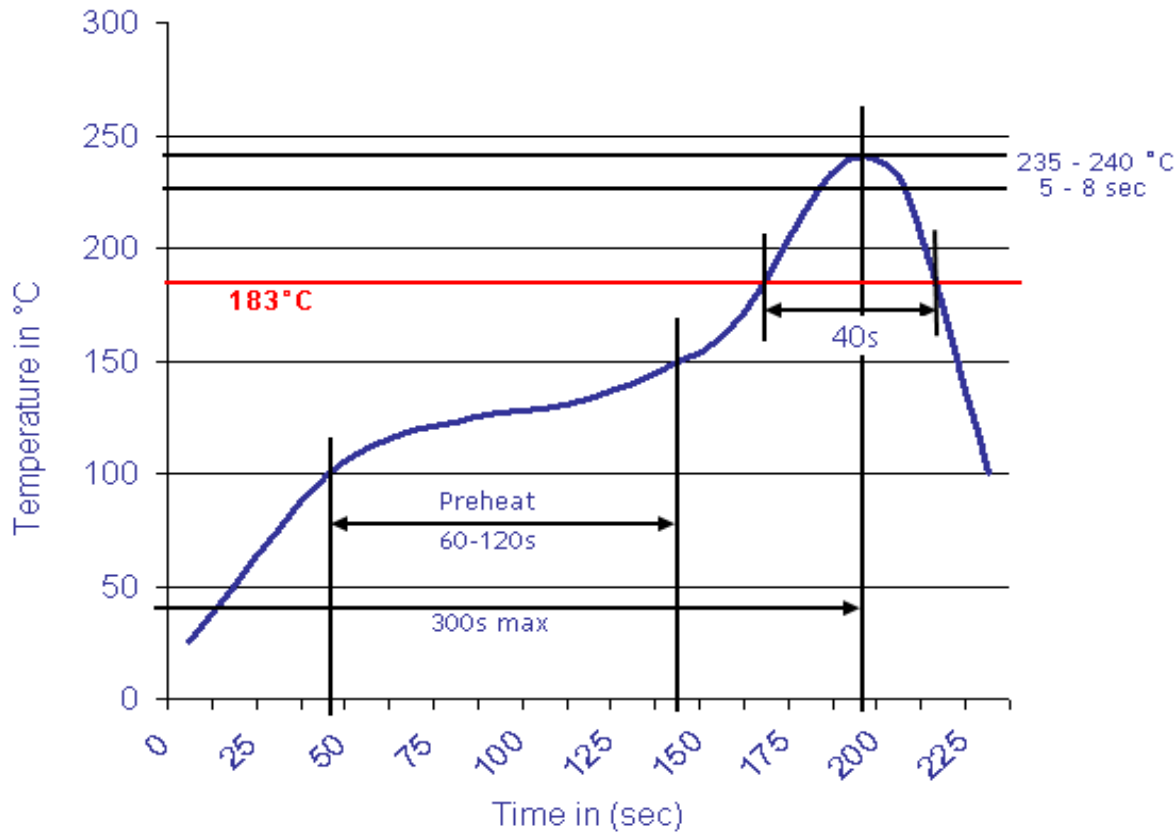

SMC-Connector Male **Q**
Type H= 9,9mm

Part No.: **T15G009**

APPD:	Schumi		FINISH	Jamy		Sheet No.	5 from 5	Customer:
-------	--------	--	--------	------	--	-----------	----------	-----------

www.edcon-components.com

email: info@edcon-components.com

Copyright by S.Tiede