

# EDCON-COMPONENTS

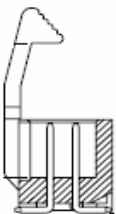

## Specifications

Current Rating:	3,0A
Voltage Rating:	350V
Insulation Resistance:	1000M Ohm min.
Contact Resistance:	20milli Ohm max.
Dielectric Voltage:	1000V AC for one minute
Operating Temperature:	. -40°C ~ to +105°C
Insulator Material:	PBT/PA6T+30% G.F.(UL94V-0)
Contact Pin:	Brass
Contact Plating:	Gold Flash all over
Latch Material:	Zinc Alloy
Latch Plating:	Ni.

Above 26 Poles with E Profile

## Drawing

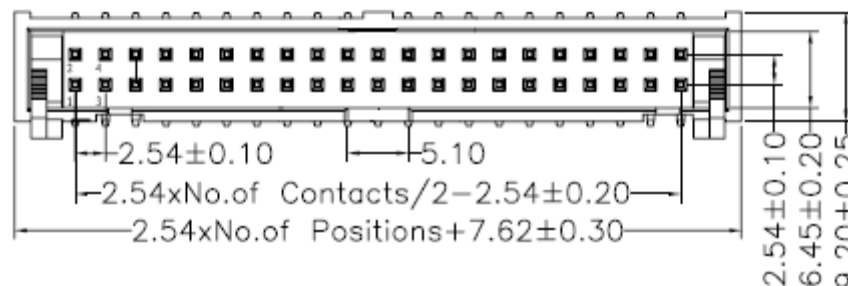

## PCB Layout

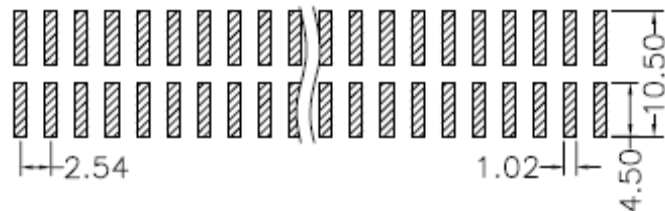

Short Latches Dimension D= 10,65mm  
Long Latches Dimension D= 14,55mm

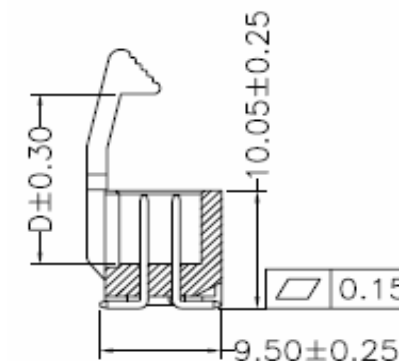
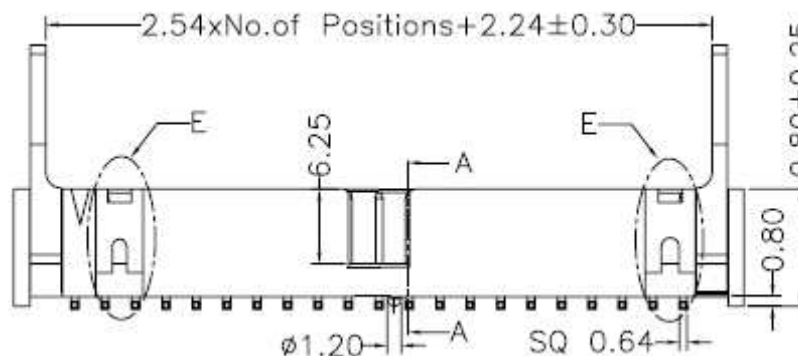

**Box Header Pitch**  
**2,54x2,54mm**

Part No.: **T14A007**

Customer:

DRW:	Jason	CHKD	Wilson	MATL:	Wilson	TOLERANCE	Mason	DATE	10.04.2009
APPD:	Schumi			FINISH	Jamy		Sheet No.	1 from 4	

# EDCON-COMPONENTS

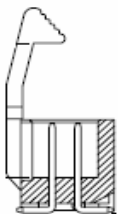

## Pin Code length table free configuration

Dimension ( mm)				
	A			
A01	9,50			
A02				
A03				
A04				
A05				
A06				
A07				
A08				
A09				
A10				
A11				
A12				
A13				
A14				
A15				
A16				
A17				
A18				
A19				
A20				
A21				
A22				

Dimension ( mm)				
	A			
A23				
A24				
A25				
A26				
A27				
A28				
A29				
A30				
A31				
A32				
A33				
A34				
A35				
A36				
A37				
A38				
A39				
A40				
A41				
A42				
A43				
A44				

Dimension ( mm)				
	A			
A45				
A46				
A47				
A48				
A49				
A50				
A51				
A52				
A53				
A54				
A55				
A56				
A57				
A58				
A59				
A60				
A61				
A62				
A63				
A64				
A65				
A66				

<b>Box Header Pitch</b> <b>2,54x2,54mm</b>	
Part No.:	<b>T14A007</b>
Customer:	

DRW:	Jason	CHKD	Wilson	MATL:	Wilson	TOLERANCE	Mason	DATE	10.04.2009
APPD:	Schumi			FINISH	Jamy		Sheet No.		2 from 4

# EDCON-COMPONENTS

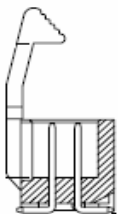

## Ordering Informations

Serie	No. of Pos.	Contact Plating	Material	Color of Body	Pin Length Configuration	Option Latches	ROHS	Packing		
<b>T14A007</b>	<b>XX</b>	<b>G0</b>	<b>PB</b>	<b>BK</b>	<b>A01</b>	<b>S</b>	<b>R</b>	<b>BU</b>		

<b>XX=</b> 6, 8, 10, 14, 16, 20, 26, 30, 34, 40, 50, 60, 64	<b>G0=</b> Gold Flash	<b>PB=</b> PBT	<b>BK=</b> Black	<b>Axx =</b> Look Table	<b>S=</b> Short Latches	<b>N=</b> NO ROHS conform	<b>BU=</b> Bulk Ware
	<b>T0=</b> Tin plated	<b>PA=</b> PA6T +30% GF f. ROHS	<b>BL=</b> Blue		<b>L=</b> Long Latches	<b>R=</b> ROHS conform	<b>TU=</b> Tube Packing
	<b>GA=</b> 3µ Gold Plating		<b>GR=</b> Gray (427°C)		<b>N=</b> without Latches		<b>TY=</b> Tray
	<b>GB=</b> 5µ Gold Plating		<b>EG=</b> Gray (413°C)				
	<b>GC=</b> 10µ Gold Plating						
	<b>GD=</b> 30µ Gold Plating						
	<b>S0=</b> Selectiv Plating Gold Flash / Tin						
	<b>SD=</b> Selectiv Tin/ 5µGold						
<b>SD=</b> Selectiv Tin/ 10µ Gold Flash							
<b>SD=</b> Selectiv Tin/ 20µ Gold	<b>SD=</b> Selectiv Tin/ 30µ Gold						

<b>Box Header Pitch</b> <b>2,54x2,54mm</b>
Part No.: <b>T14A007</b>
Customer:

DRW:	Jason	CHKD	Wilson	MATL:	Wilson	TOLERANCE	Mason	DATE	10.04.2009
APPD:	Schumi			FINISH	Jamy		Sheet No.		3 from 4

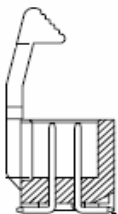

## Soldering Profile for Lead Soldering ( P.B.T. )

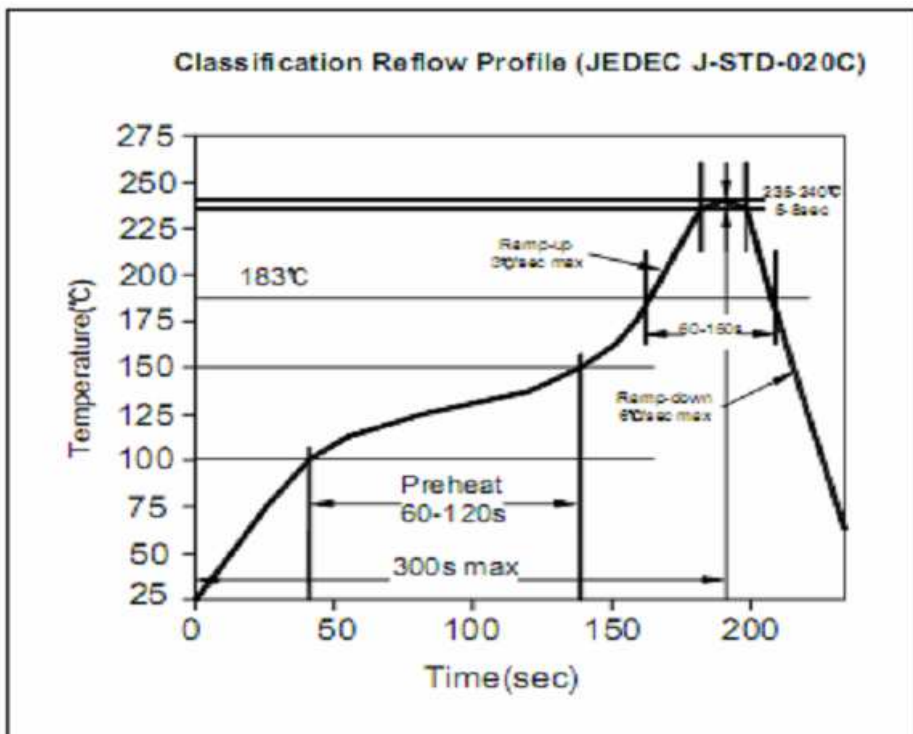

## Soldering Profile for Lead Free Soldering ( Nylon 6T )

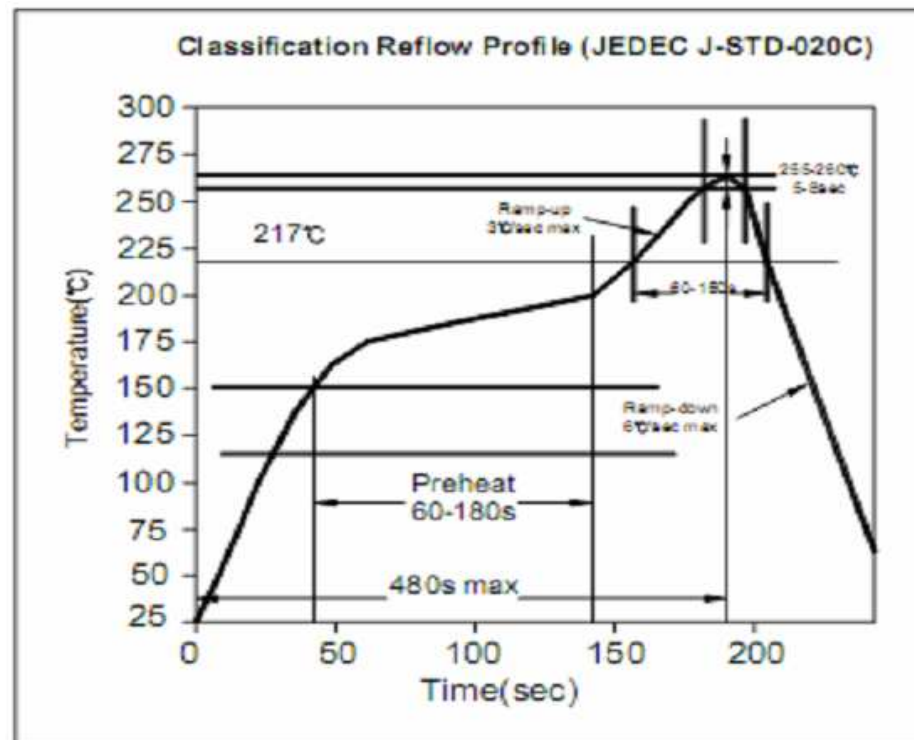

<b>Box Header Pitch</b>	
<b>2,54x2,54mm</b>	
Part No.:	<b>T14A007</b>
Customer:	

DRW:	Jason	CHKD	Wilson	MATL:	Wilson	TOLERANCE	Mason	DATE	10.04.2009
APPD:	Schumi			FINISH	Jamy		Sheet No.	4 from 4	