

EDCON-COMPONENTS



Product Specifications

Safety: Low Voltage DC-Drives (<50V)
 Firmness: Good Alloy Material
 High illumination: High Quality LED Chip with long life high lminious efficiency
 Easy installation: Power supply from both sides can be used a common LED light
 High optical uniformity: Didused cover, no Glare
 Apply to: Parking Bar Bedroom snd so on not ask for much brightness on the environment places

Environmental requirements

Working Temperature: -20°C ~ +40°C
 Storage Temperature: -30°C ~ +60°C
 Working Humidity: 30% ~ 85%
 Storage Humidity: 10% ~ 90%
 Storage conditions:
 Indoor ventilation air should not be corrocive gases

Type	Length	LED Type/Quantity	Material	Material	Light Effect	Protection Grade	Application
T5 LED TUBE	600mm	110PCS/3528	Alloy + PC	Stripe/Silver	Diffused	IP54	Lighting

Length	Voltage DC(V)	Power (Watt)	Suitable for use (W)
600mm	36 +/- 0,5	7	14

Color Tone Code	Light Color	TC (K)	Color Coordinate	Display Index	Luminious Flux (LM)	Angle
PW	Pure White	6500	X=0,313 / Y=0,337	80	200	120
WW	Warm White	3500	X=0,409 / Y=0,394	60	190	120

LED-TUBE
Part No.: M23005
Customer:

DRW:	Jason	CHKD	Wilson	MATL:	Wilson	TOLERANCE	Mason	DATE	10.04.2009
APPD:	Schumi			FINISH	Jamy		Sheet No.		1 from 2

EDCON-COMPONENTS



Exterior Dimensions

Type	Length	A	B		C		D (max.)	Lampholders Type
		max. (mm)	min. (mm)	max. (mm)	min. (mm)	max. (mm)	T5 (mm)	
T5 LED TUBE	600	549	553	556		563	16	G5

Installation

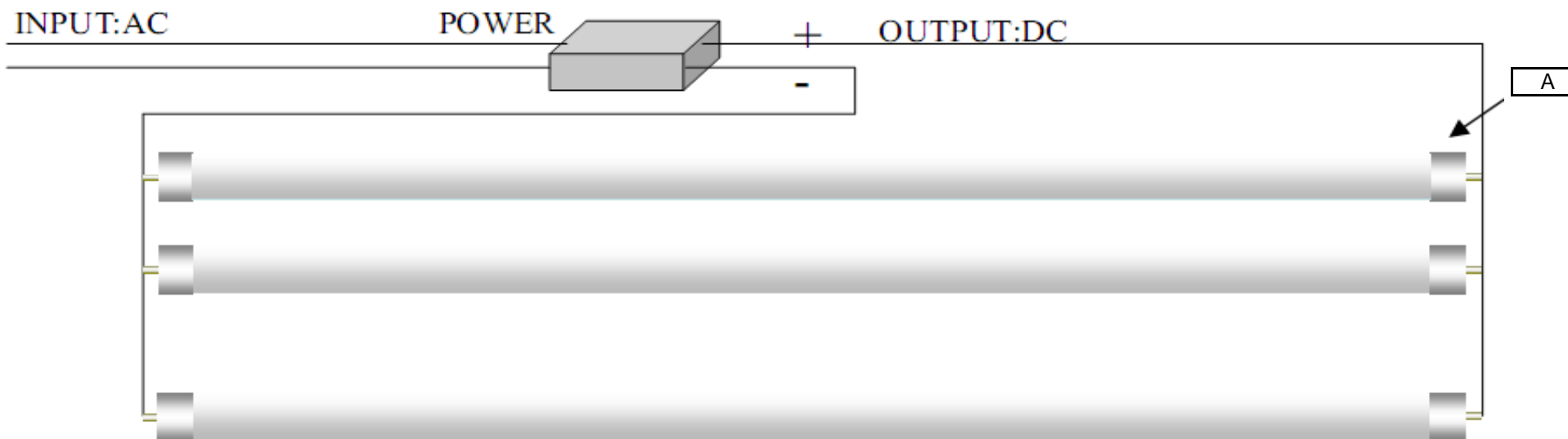

A Labels affixed to one end for the cathode, the other side for negative.
Please note the distinction between installation polarity.

LED-TUBE	
Part No.:	M23005
Customer:	

DRW:	Jason	CHKD	Wilson	MATL:	Wilson	TOLERANCE	Mason	DATE	10.04.2009
APPD:	Schumi			FINISH	Jamy		Sheet No.		2 from 2

EDCON-COMPONENTS



Installation location

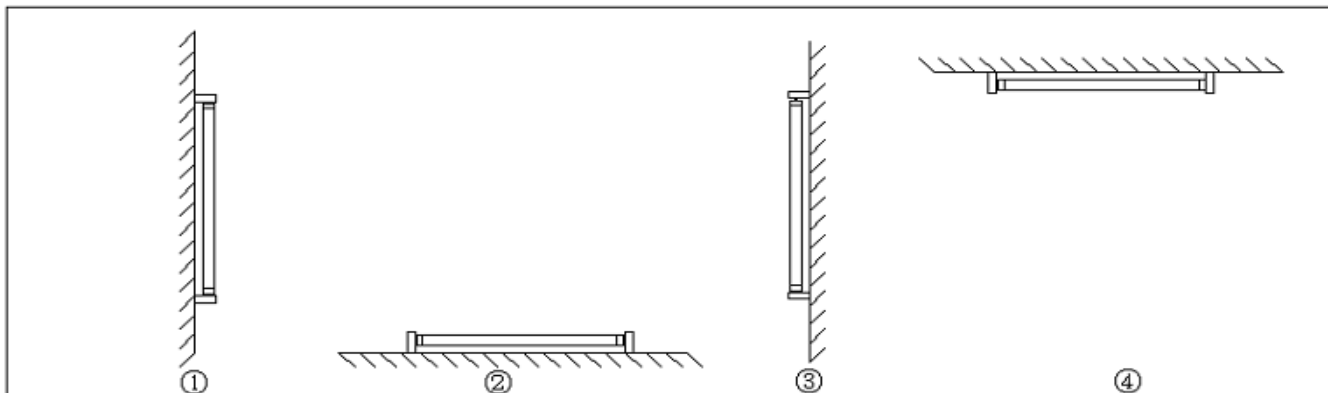

Ordering Informations

Serie	Length of	Color Tone	ROHS	Packing						
M23005	601	WW	R	CA						

601 = 600mm	WW = Warm White	N =NO ROHS conform	CA = Cartoon
	PW = Pure White		
		R =ROHS conform	

LED-TUBE
Part No.: M23005
Customer:

DRW:	Jason	CHKD	Wilson	MATL:	Wilson	TOLERANCE	Mason	DATE	10.04.2009
APPD:	Schumi			FINISH	Jamy		Sheet No.	2 from 2	

www.edcon-components.com

email: info@edcon-components.com