

EDCON-COMPONENTS

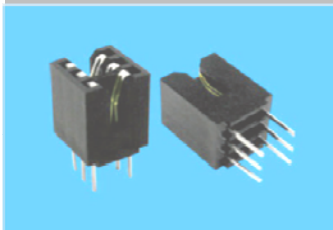

Technical Drawing

Technical Specification

Material:

Insulator: Glass-Reinforced Thermoplastic (PBT)
 UL-Rated: UL94V-0
 Contact: Copper Alloy
 Mating Area: G/F Gold over Nickel
 Solder Area: 120µ Tin over 50µ Nickel
 Body Colour: Green

Electrical

Dielectric Withstanding Voltage 1000VAC RMS
 Current Rating: 3A
 Insulation Resistance: 5000Mege Ohms min @500VDC
 Contact Resistance: 20milli Ohm max.

Mechanical

Insertion Force: 340gr. Max. per Contact pair
 Withdrawal Force: 28grams min per Contact Pair
 Temperature Range: -550°C to + 95°C

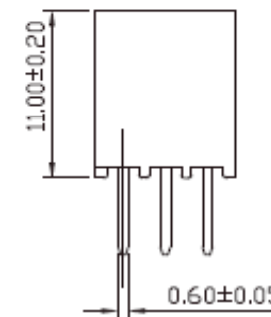
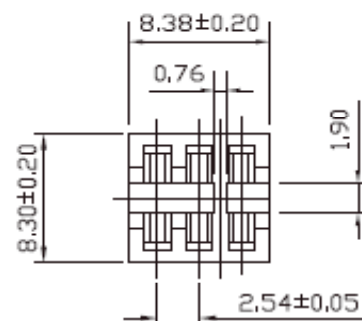
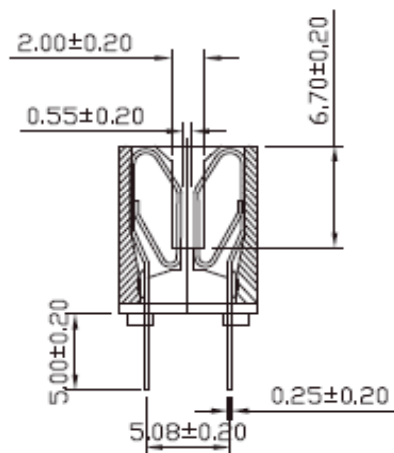

PCB-Layout (mm)

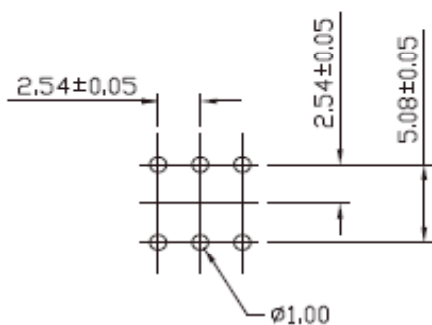

THT Slot -Connector SIDE-OPEN	
RM 2,54mm	
Part No.:	T63034
Customer:	

DRW:	Jason	CHKD	Wilson	MATL:	Wilson	TOLERANCE	Mason	DATE	13.11.2020
APPD:	Schumi			FINISH	Jamy		Sheet No.		1 from 3

EDCON-COMPONENTS

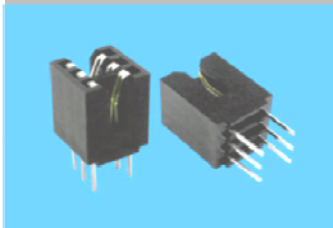

Ordering Informations

Serie	No of Pos.	Contact Plating	Spezial Function	Spezial Function	Spezial Function	ROHS	Packing			
T63034	06	S0	0	0	0	R	TU			

06= 6 Position	G0= Gold Flash	0= No function	0= No function	0= No function	R= ROHS Conform	TU= Tube Packing
	S0= Selectiv Gold Flash					TY= Tray Package
	T0= Tinned					

THT Slot -Connector SIDE-OPEN	
RM 2,54mm	
Part No.:	T63034
Customer:	

DRW:	Jason	CHKD	Wilson	MATL:	Wilson	TOLERANCE	Mason	DATE	13.11.2020
APPD:	Schumi			FINISH	Jamy		Sheet No.		2 from 3

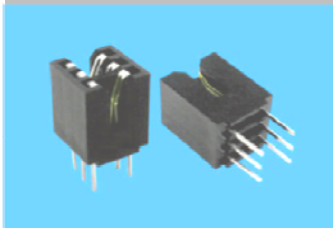

Soldering Profile Curve

Classification Reflow Profile (JEDEC J-STD-020C)

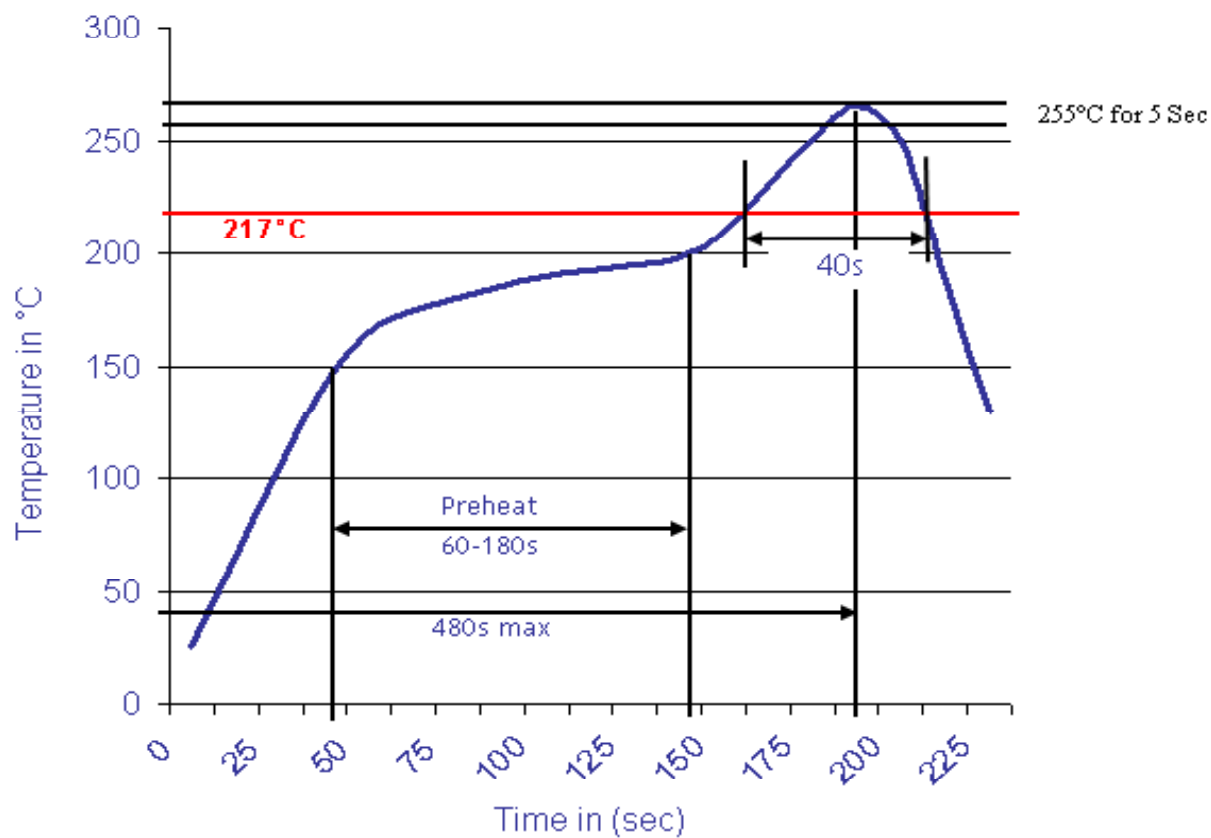

THT Slot -Connector SIDE-OPEN RM 2,54mm	
Part No.:	T63034
Customer:	

DRW:	Jason	CHKD	Wilson	MATL:	Wilson	TOLERANCE	Mason	DATE	13.11.2020
APPD:	Schumi			FINISH	Jamy		Sheet No.		3 from 3