

Code

EDCON-COMPONENTS



Features

Inductive proximity sensor.

Style: cylinder shape M5, M8, M12, M18, M30 various rectangular shape and protruding shape.

Shielded or unshielded type.

DC 2-wire (10-30V DC), DC3-wire (10-30V DC), DC-4Wire (10-30V DC), AC 2-wire (90-250V AC) type.

Connection Mode: 3 or 4 wires or 3 or 4 pin M8 or M12 connector.

With LED operation indicator, easily identifiable.

Brass nickle plated, proof of oil, water acid, alkaline.

Standard sensing object: inductive sensor: ferrous metals; capacitive sensor: metal or non metals objects.

Protection IP-rate: IP67, water resistant:

Over-load and short circuit protection; polarity reversal protection.

Widely applied in measuring, Counting, RPPm measuring in mechanismus, chemical paper manufacture light industry, etc.

Technical Dimension

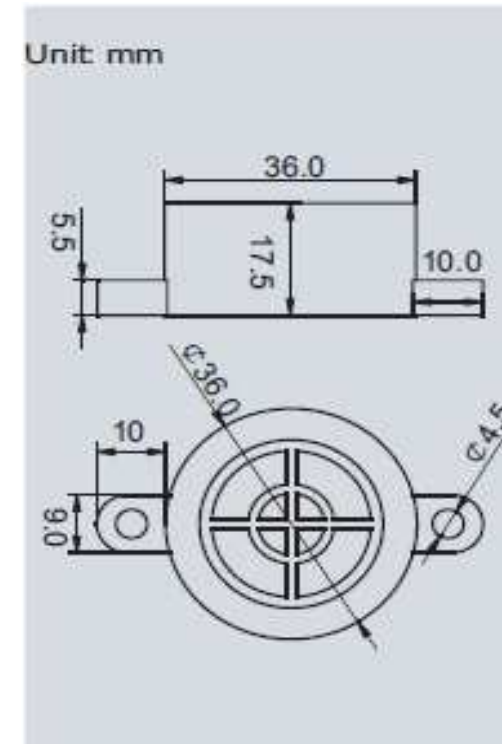

CAPACITIVE Proximity Sensor

Part No.: **25B1008**

Customer:

DRW:	Jimmy	CHKD	Ban	MATL:	Wilson	TOLERANCE	Mason	DATE	10.08.2009
APPD:	Johnson			FINISH	Jamy		Sheet No.		1 from 5

www.edcon-components.com

email: info@edcon-components.com

EDCON-COMPONENTS



Technical Discription

Dimension :	36x17,5mm
Installation	Flush (shielded)
Mounting Distance Sn	15,0mm
Detect distance Sa	0 - 13,5m
Rated Operating Voltage	24 VDC / 220VAC
Supply Voltage	10 ~ 30VDC / 90-250VAC
Voltage Drop	≤ 2V
Rated Insulation Voltage	≥ 20M Ω
Load current capacity	200mA / 300mA
Off-state current (NPN/PNP)	≤ 15mA
Leak current	≤ 20μA
Against polarity reversal	YES
Short circuit protected	
Repeated accuracy	≤ 5%
Ambient temperature range	.-25°C ~ +70°C
Operating frequency	30Hz / 10Hz
Function indication	RED Led Indicator
IP ratings	IP67
Housing Material	ABS
Material of Sensing face	ABS
Connection	wire
No of wires & gauge	12x0,16mm
Standard length of cable	2M
Plug-in connector	NO

Connection Mode

Output Code A or B

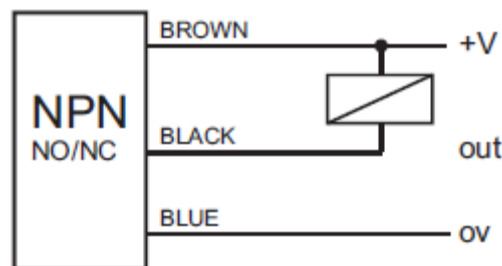

Output Mode Code E

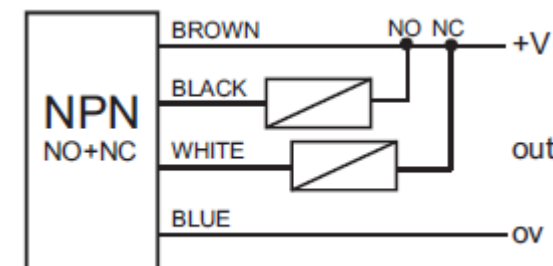

Output Mode Code C or D

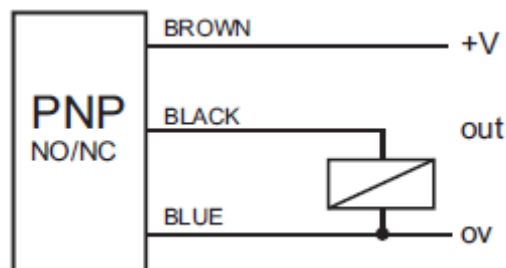

Output Mode Code F

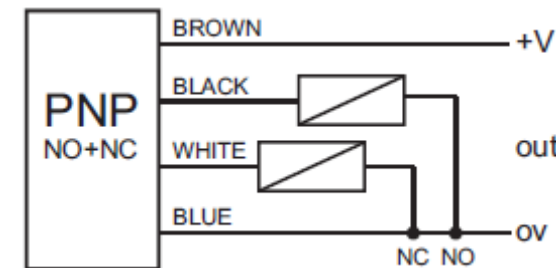

CAPACITIVE Proximity Sensor

Part No.: **25B1008**

Customer:

DRW:	Jimmy	CHKD	Ban	MATL:	Wilson	TOLERANCE	Mason	DATE	10.08.2009
APPD:	Johnson			FINISH	Jamy		Sheet No.	2 from 5	



Capacitive Proximity Application Direction

- A.** Capacitive proximity sensor can measure both metal and non-metal objects, such as iron, water, oil glass, plastic...etc,. The mounting distance varies with different objects because of different object conductivity, permittivity and water absorption. If the metal connects with ground (GND), the max. Mounting distance can be obtained.
- B.** Different objects, the mounting distance is different, refer to Table 1
- C.** The mounting distance of Capacitive proximity sensors can be adjusted, and the mounting distance must be adjusted before installing, instead of after. Adjustment please refer to Table 2
- D.** When operating, the capacitive proximity sensors should be far away from the high frequency electromagnetism circumstance, for example, supersonic wave emitter, high frequency.

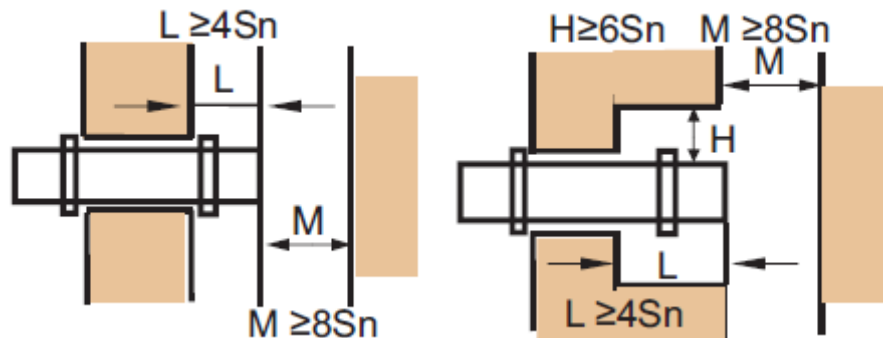

Connection Mode

Output Mode Code G or H

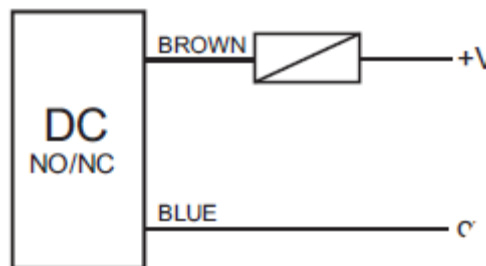

Output Mode Code J or K

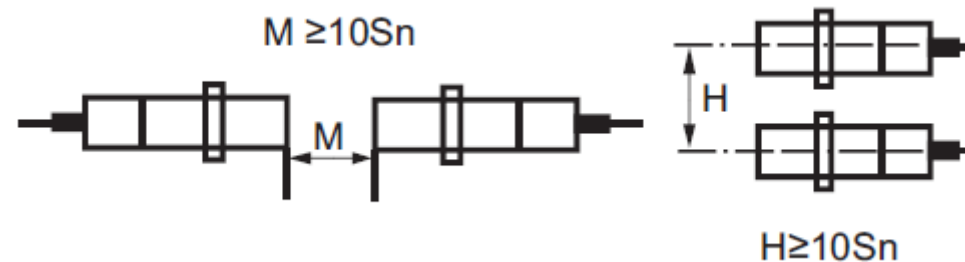
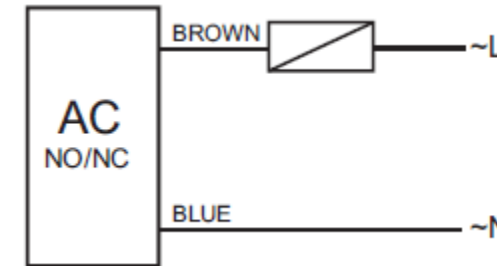

CAPACITIVE Proximity Sensor	
Part No.:	25B1008
Customer:	

DRW:	Jimmy	CHKD	Ban	MATL:	Wilson	TOLERANCE	Mason	DATE	10.08.2009
APPD:	Johnson			FINISH	Jamy		Sheet No.		3 from 5

EDCON-COMPONENTS



Adjustment Table 2

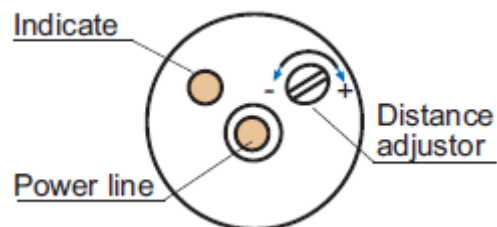

Adjustor turns right Sn increases turn left Sn decreases, the circle on Sn adjustor about ten.



Without object, turn adjustor right to the **ON** stop.



Approaching object, turn adjustor left to the **OFF** stop.

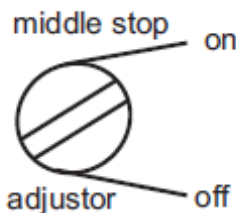

At least set the adjust in the middle of **ON** and **OFF** position.

Mounting distance Table 1

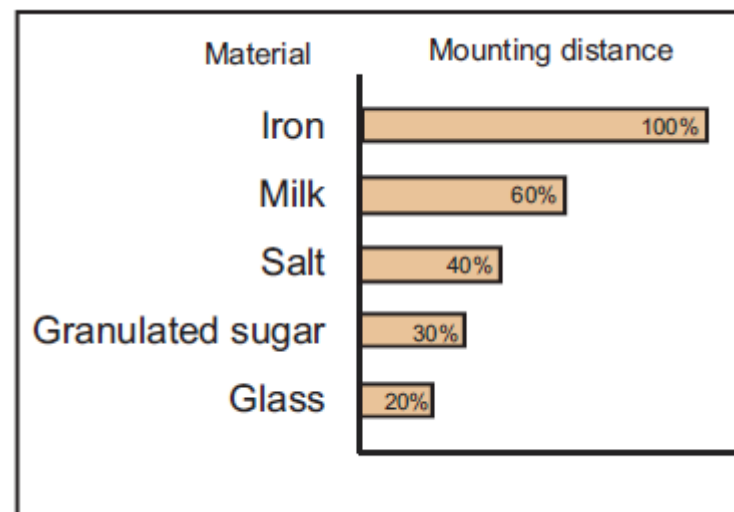

CAPACITIVE Proximity Sensor

Part No.: **25B1008**

Customer:

DRW:	Jimmy	CHKD	Ban	MATL:	Wilson	TOLERANCE	Mason	DATE	10.08.2009
APPD:	Johnson			FINISH	Jamy		Sheet No.	4 from 5	

EDCON-COMPONENTS



Ordering Informations

Serie	Connector	Connector Size	Zylinder Size	Output Mode	Detect Distance	Output Current	Body Sensor Length	Housing	Cable length	
25B1008	C	X	F36	A	15	B	0	A	2001	

C= Cable	X= without connector	F36= 36x17,5mm	A= NPN-NO			0= NO function	A= ABS is Standard	0000= without Cable
			B= NPN-NC			B= 200mA		2001= Standard Cable length is 2000mm other length available please fill in
			C= PNP-NO			C= 300mA		
			D= PNP-NC					
			E= NPN-NO+NC					
			F= PNP-NO+NC					
				15= 15mm				
			J= AC2 Wire NO					
			K= AC2 Wire NC					

For special request of sensors (e.g. 24V AC appearance, function), please indicate when order.

CAPACITIVE Proximity Sensor	
Part No.:	25B1008
Customer:	

DRW:	Jimmy	CHKD	Ban	MATL:	Wilson	TOLERANCE	Mason	DATE	10.08.2009
APPD:	Johnson			FINISH	Jamy		Sheet No.	5 from 5	