



STAR ALLIANCE TECHNOLOGIES Home and Building Applications



FEATURES:

- POWER LED 3.6 Watt
- Base / Socket: E17
- More than 50,000 hours
- 70 mm ball shape bulb
- Low heat, no UV or IR light radiation
- Instand "ON" to 100% brightness
- No mercury or other inorganic
- Homogeneous flood illumination
- 4 Watt version can achieve directional light output equal to 30 Watt halogen lamp
- Consume 80% less power than halogen lamp
 - Reverse polarity protection
- 1 Year limited warranty look at page no. 7
- Works with 110~240V AC lighting systems

Applications:

- Accent Lighting
- Amusement Park Lighting
- Bath and Vanity Lighting
- Energy Saving Programs
- Replace Standard GLS lamps

STAR ALLIANCE TECHNOLOGIES
Home & Building Applications

CHKD	Schumann					MATL:	Schroeder	08.11.2008			
						FINISH	Müllerbach				
DRW:	Müller		TOLERANCE	Heermann	DATE						
APPD:	Bruchmann				Sheet No. 1 from 7	Part No.:		1210120			



STAR ALLIANCE TECHNOLOGIES Home and Building Applications

Product Specifications

Light Source:	1 x 3.6 Watt
Optics:	White diffused glass lens
Lens Diameter:	70 mm ball shape blub
Beam Angle:	120° (Flood)
Rendering Index:	> 60 (for cool white color) > 65 (for natrual white color) > 70 (for warm white color)
Total Length:	127.00 mm
Weight:	55 g ± 2 g
Heatsink	Machined pure aluminum with anodize finish
Base:	E17
Dimmability:	not dimmable

Environmental Specifications

Temperature Range:	Ambient: -20°C to 40°C, Surface of Lamp 60°C to 70°C
Humidity Range:	0 to 95% non-condensing humdity

Electrical Specifications

Voltage Requirement:	110 or 230V AC
Power Consumption:	≤ 4.0 W
Power Factor:	≥ 0.5

STAR ALLIANCE TECHNOLOGIES
Home & Building Applications

CHKD	Schumann					MATL:	Schroeder	08.11.2008			
						FINISH	Müllerbach				
DRW:	Müller		TOLERANCE	Heermann	DATE						
APPD:	Bruchmann				Sheet No. 2 from 7	Part No.:					1210120



STAR ALLIANCE TECHNOLOGIES Home and Building Applications

Technical Drawing (mm)

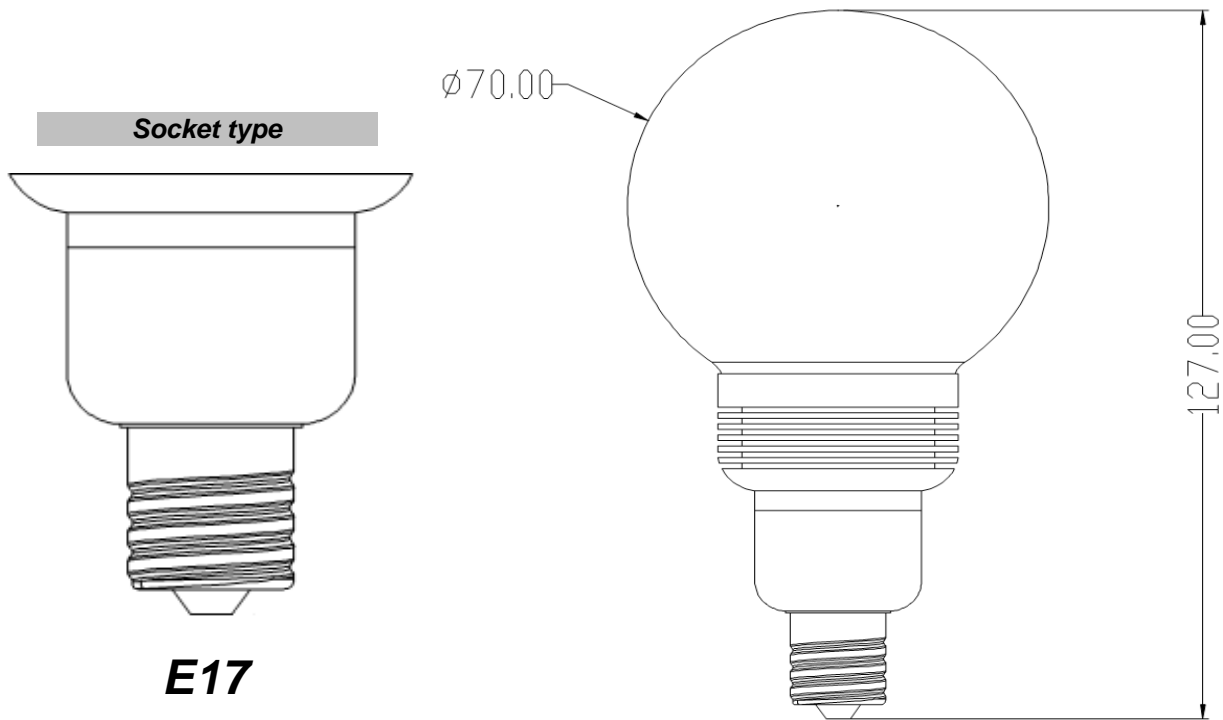

STAR ALLIANCE TECHNOLOGIES
Home & Building Applications

CHKD	Schumann					MATL:	Schroeder	08.11.2008			
						FINISH	Müllerbach				
DRW:	Müller		TOLERANCE	Heermann	DATE						
APPD:	Bruchmann			Sheet No. 3 from 7			Part No.:	1210120			



STAR ALLIANCE TECHNOLOGIES Home and Building Applications

Illumination Characteristics (T = 25°C)

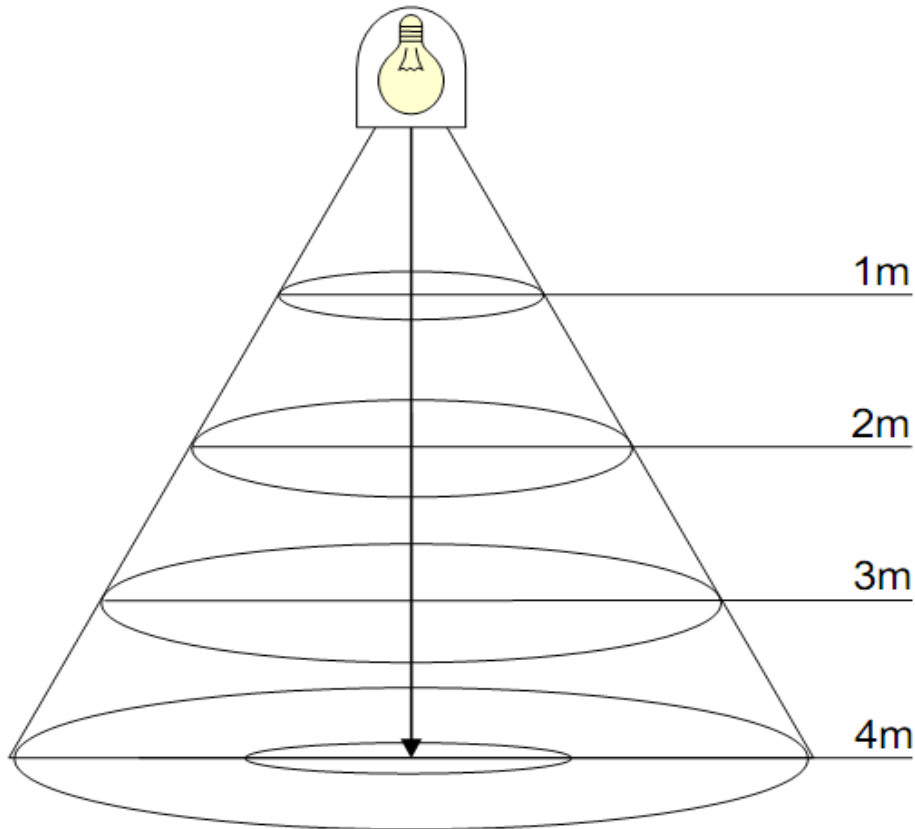

Color	W	N	C
-------	---	---	---

1m	Lux	12	15	---
	Dia	---	----	----

2m	Lux	9	6	---
	Dia	---	----	----

3m	Lux	5	3	---
	Dia	---	----	----

4m	Lux	3	2	---
	Dia	---	----	----

W = Warm White
N = Natural White
C = Cool White

The center beam lux is measured with digital Lux Meter (Model TES-1334-A)

STAR ALLIANCE TECHNOLOGIES
Home & Building Applications

CHKD	Schumann				MATL:	Schroeder	08.11.2008			
					FINISH	Müllerbach				
DRW:	Müller		TOLERANCE	Heermann	DATE					
APPD:	Bruchmann			Sheet No. 4 from 7	Part No.:		1210120			



STAR ALLIANCE TECHNOLOGIES Home and Building Applications

Packing Specifications

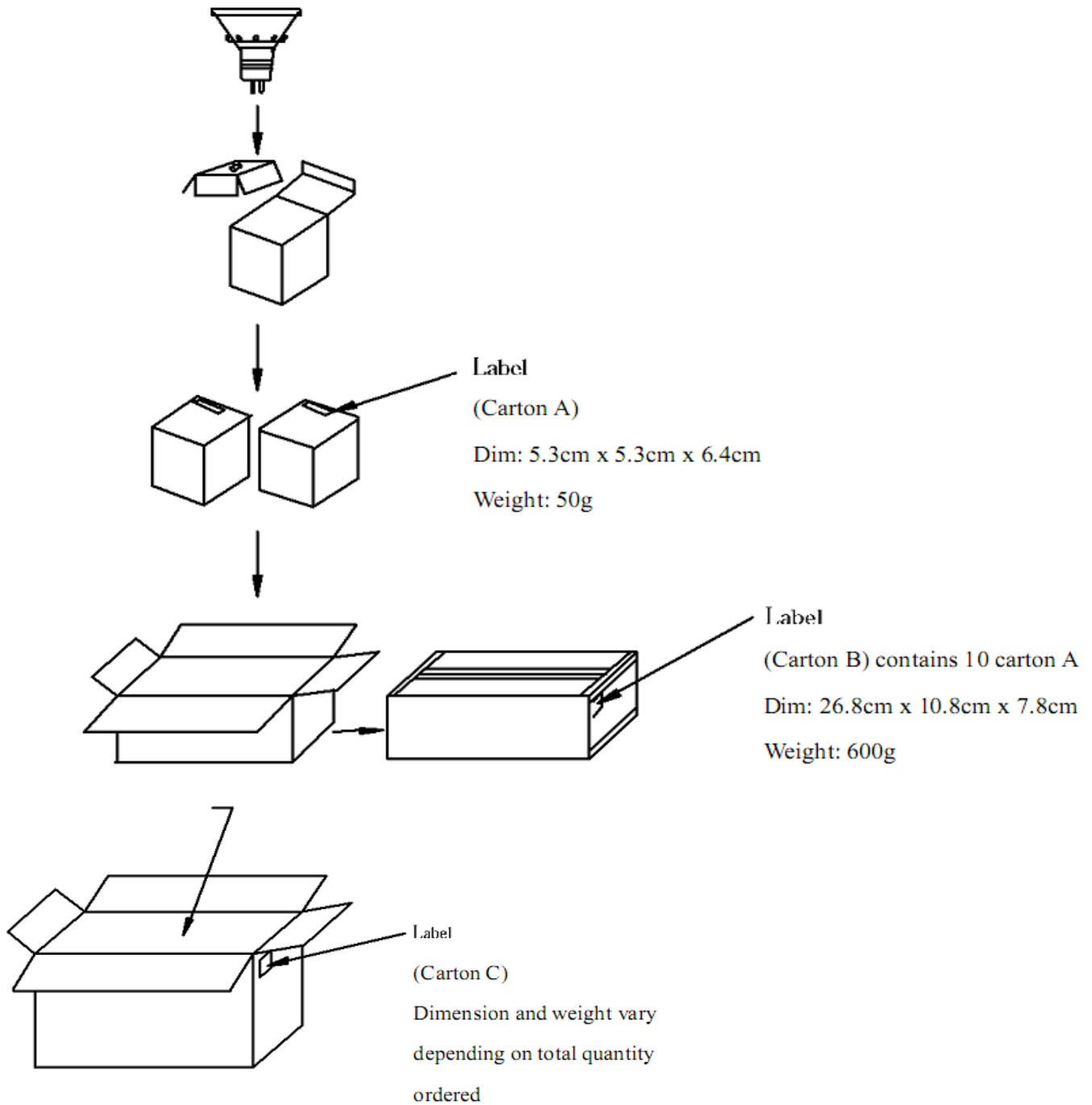

STAR ALLIANCE TECHNOLOGIES
Home & Building Applications

CHKD	Schumann					MATL:	Schroeder	08.11.2008			
						FINISH	Müllerbach				
DRW:	Müller		TOLERANCE	Heermann	DATE						
APPD:	Bruchmann			Sheet No. 5 from 7	Part No.:					1210120	



STAR ALLIANCE TECHNOLOGIES Home and Building Applications

Ordering Informations

Serie	Power	Color Code	Beam Shape	Voltage	Base
1210120	4	W	F	U	17
	4 = 4 Watt	W = Warm N = Natural C = Cool	F = Flood (120°)	U = 110 V E = 230 V	E17

Product Informations

Color	CCT (K / nm)	Operating Voltage (V AC)	LED Power (W)	Typical Luminous Flux (lm)	Beam Angle (°)
Warm White	2600~3000	110 or 230	1 x 3.6	180	120 ±2
Natural White	5000~6000			230	
Cool White	6000~7000			280	

Typical Electrical Characteristics at T=25°C

Parameter	Symbol	Min.	Typ.	Max.	Unit
Input Voltage (110VAC)	V _{AC}	100	----	120	V
Input Voltage (230VAC)	V _{AC}	200	----	240	V
LED Forward Current	I _f	----	350	---	mA
Estimated Life Time		----	50,000	----	Hours
Optimized Body Temperature	T	----	55	60	°C

STAR ALLIANCE TECHNOLOGIES
Home & Building Applications

CHKD	Schumann				MATL:	Schroeder	08.11.2008
					FINISH	Müllerbach	
DRW:	Müller	TOLERANCE	Heermann	DATE			
APPD:	Bruchmann		Sheet No. 6 from 7		Part No.:	1210120	



STAR ALLIANCE TECHNOLOGIES Home and Building Applications

Warranty Discription

EDCON WARRANTY

Manufacturer warrants to the Purchaser that each Product manufactured and sold by it will be free from defects in material and workmanship in its intended use (normal wear and tear excepted) for the period of one year from date of Purchasers purchase (the invoice date) from Manufacturer. Manufacturers warranty flows only to Purchaser. If any Product covered by this warranty is returned by Purchaser in accordance with Manufacturers Products Return Policy, including without limitation its return authorization provisions, within the applicable warranty period set forth above, and upon examination Manufacturer determines to its satisfaction that such Product was defective in material or workmanship at the time of delivery to the Purchaser. Manufacturer will, at its option, repair or replace the Product or the defective part thereof, or reimburse Purchaser for the purchase price. For purposes of clarity, "repair or replace the Product or the defective part thereof" does not include any reinstallation costs or expenses. If Manufacturer chooses to replace the Product and is not able to do so because it has been discontinued or is not available, Manufacturer may replace it with a comparable product. The Products Return Policy is posted on Manufacturers Internet web site at <http://www.edcon-components.com>. The foregoing notwithstanding, Manufacturer will not be responsible for damage to any Product resulting from misuse, negligence, acts of God or accident or resulting from repairs or alterations made by any person or firm not duly authorized by Manufacturer in writing. Purchaser shall convey with each Product distributed to end users the MANUFACTURERS WARRANTY included by Manufacturer with such Product, and, if Manufacturer determines that the appropriate remedy for a defective product is refund of Purchasers purchase price, Purchaser shall refund to the end user (or arrange for the refund to the end user of) the full purchase price paid by the end user for such defective Product. The Products Return Policy is posted on Manufacturers Internet web site at <http://www.edcon-components.com>. The foregoing notwithstanding, Manufacturer will not be responsible for damage to any Product resulting from misuse, negligence, acts of God or accident or resulting from repairs or alterations made by any person or firm not duly authorized by Manufacturer in writing. Purchaser shall convey with each Product distributed to end users the MANUFACTURERS WARRANTY included by Manufacturer with such Product, and, if Manufacturer determines that the appropriate remedy for a defective product is refund of Purchasers purchase price, Purchaser shall refund to the end user (or arrange for the refund to the end user of) the full purchase price paid by the end user for such defective Product.

THIRD PARTY WARRENTIES

With respect to products sold to the Purchaser by Manufacturer but not manufactured by Manufacturer, MANUFACTURER MAKES NO WARRANTY OF ANY KIND, EXPRESS OR IMPLIED, INCLUDING, WITHOUT LIMITATION; ANY WARRANTY OF MERCHANTABILITY OR FITNESS FOR A PARTICULAR PURPOSE, but will make available to the Purchaser, to the extent permitted by law and relevant contracts, the warranties of manufacturer of the relevant product upon the Purchasers timely written request. NON-IMPLIED WARRANTIES

NON-IMPLIED WARRENTIES

THE WARRANTIES GIVEN IN THESE ARE THE ONLY WARRANTIES GIVEN BY THE MANUFACTURER WITH RESPECT TO THE PRODUCTS AND ARE GIVEN IN LIEU OF ALL OTHER WARRANTIES OR IMPLIED, INCLUDING, BUT NOT LIMITED TO, WARRANTIES OF MERCHANTABILITY, OF NON INFRINGEMENT AND OF FITNESS FOR A PARTICULAR PURPOSE. PURCHASERS EXCLUSIVE REMEDIES, AND MANUFACTURERS SOLE LIABILITY, FOR ANY NONCONFORMITY OR DEFECT IN ANY PRODUCT SHALL BE THOSE EXPRESSED HEREIN. LIMITATION OF LIABILITY

LIMITATION OF LIABILITY

An essential purpose of the limited exclusive liabilities and remedies in this Agreement is allocation of risks between Manufacturer and Purchaser, which allocation of risks is reflected in the purchase price for the Products. UNDER NO CIRCUMSTANCES SHALL MANUFACTURERS LIABILITY ARISING OUT OF OR IN CONNECTION WITH THIS AGREEMENT OR MANUFACTURERS PERFORMANCE OR ASSERTED FAILURE TO PERFORM HEREUNDER, IN CONTRACT, TORT (INCLUDING NEGLIGENCE) OR OTHERWISE, EXCEED THE PURCHASE PRICE OF THE PRODUCT TO WHICH SUCH LIABILITY RELATES. IN NO EVENT SHALL MANUFACTURER BE LIABLE FOR SPECIAL, INCIDENTAL OR CONSEQUENTIAL DAMAGES, INCLUDING, WITHOUT LIMITATION, DAMAGES RESULTING FROM LOSS OF USE, PROFITS, BUSINESS OR GOODWILL, WHETHER OR NOT MANUFACTURER HAS BEEN ADVISED OF THE POSSIBILITY THEREOF.

STAR ALLIANCE TECHNOLOGIES
Home & Building Applications

CHKD	Schumann				MATL:	Schroeder	08.11.2008
					FINISH	Müllerbach	
DRW:	Müller		TOLERANCE	Heermann	DATE		
APPD:	Bruchmann			Sheet No. 7 from 7	Part No.:		1210120