

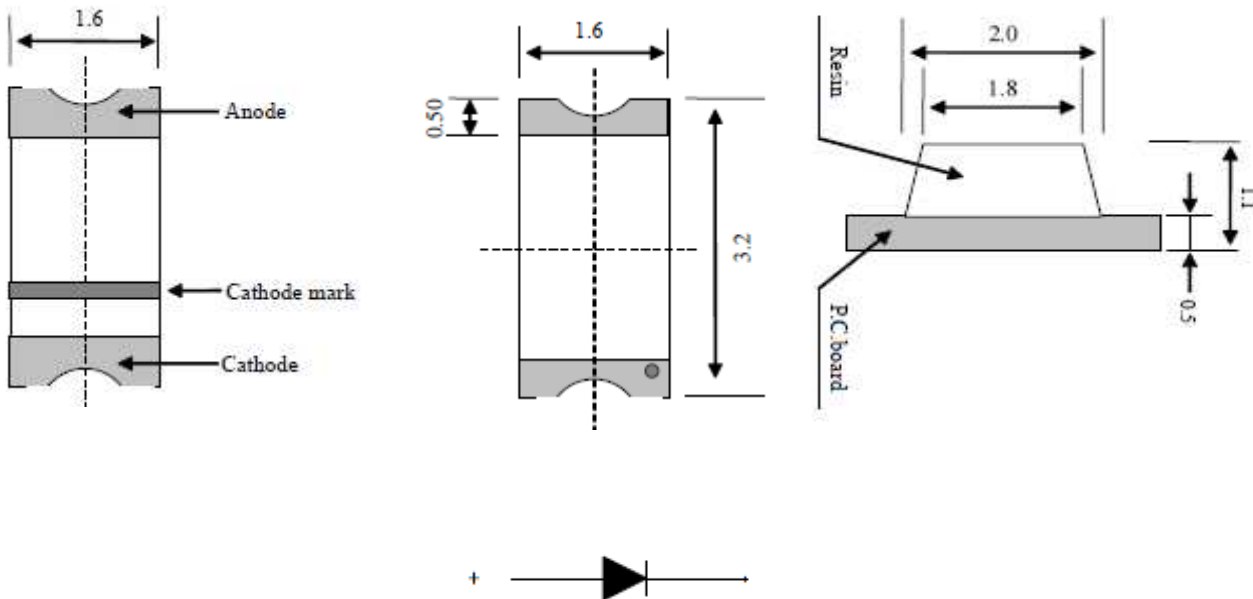

### Applications

- Interior automotive lighting(dashboard backlight etc...)
- Optical indicators
- High Tech Lightning
- Security Parts
- Automotive Products

### Package Dimensions (Tol. +/- 0,10mm)



### Recommend Soldering Pad Dimensions (Tol. +/- 0,10mm)

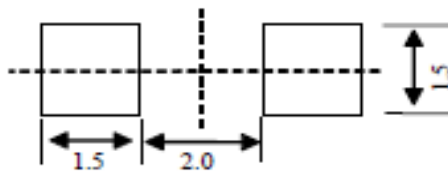

Notes:					<b>CHIP LED FOR REVERSE PCB MOUNTING</b>		
All dimensions in mm tolerance is $\pm 0.1$ mm unless otherwise noted.							
					Part.No.	M11B9018	
					Customer		
DRW:	Harry	CHKD	Dustin	Tolerance	Tolerance:	Date:	05.11.2013
APPD:	Jason	MATL	Wilson	John	MASON	Sheet No.	1 from 6

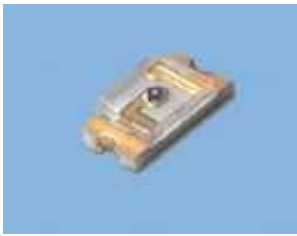

**Absolute Maximum Ratings ( Ta = 25°C)**

Item-Disription	Symbol	Value	Unit
DC Forward Current	PD	60	mW
Pulse Forward Current	IFP	70	mA
Forward Current:	IFP	25	mA
Reverse Voltage:	VR	5	V
Electrostatic Discharge:	ESD	2000	V
Operating Voltage	Topr	.-20 ~ +85	°C
Storage Temperature	Tstg	.-30 ~ +100	°C
Lead Soldering Temp.	Tsol	260°C/5Sec.	---

**Typical Electrical & Optical Characteristics ( IF=20mA and Ta = 25°C)**

Item	Symbol	Condition	Min.	Typ.	Max.	Unit
Luminious Intensity:	Iv	IF=20mA		50		mcd
Viewing Angle:	20 1/2	IF=20mA		125		Deg.
Peak Emission Wave.:	$\lambda_p$	IF=20mA				nm
Domi. Wavelength:	$\lambda_d$	IF=20mA		565		nm
Spectral Line Half-Width:	$\Delta\lambda$	IF=20mA		30		nm
DC Forward Voltage:	Vf	IF=20mA		2,00	2,50	V
DC Reverse Voltage:	Ir	Vr=5V			10	$\mu$ A
Color Temperature: (White)		IF=20mA				K
Chromaticity (White)	X	IF=20mA				
Coordinates: (White)	Y	IF=20mA				

<b>Notes:</b>					<b>CHIP LED FOR REVERSE PCB MOUNTING</b>		
1. Tolerance of measurement of luminous intensity				: $\pm 10\%$	Part.No.	<b>M11B9018</b>	
2. Tolerance of measurement of chromatic coordinates			: $\pm 1\text{nm}$				
3. Tolerance of measurement of forward voltage			: $\pm 0.1\text{V}$				
					Customer		
DRW:	Harry	CHKD	Dustin	Tolerance	Tolerance:	Date:	05.11.2013
APPD:	Jason	MATL	Wilson	John	MASON	Sheet No.	2 from 6

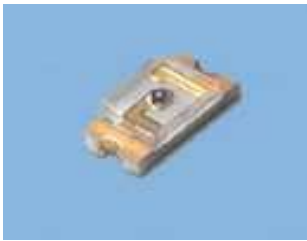

**Diagramm of viewing angle**

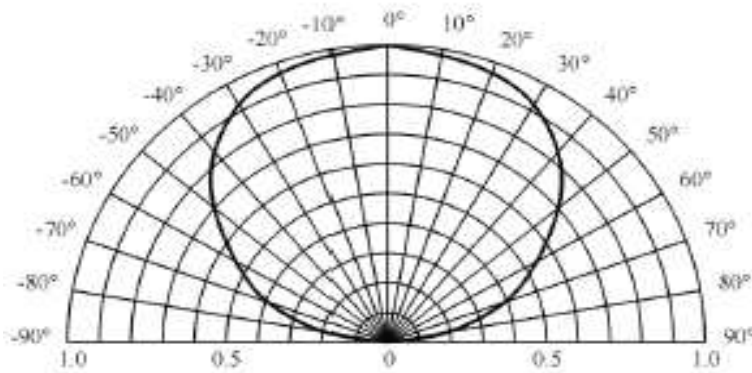

**Diagramm of LED**

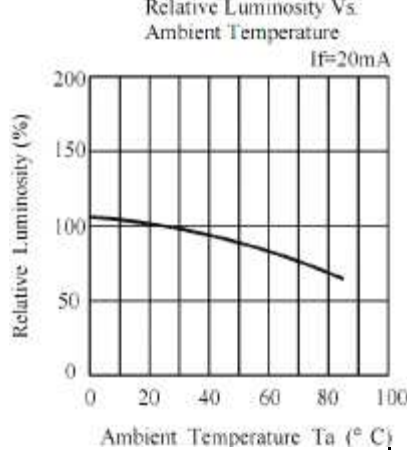
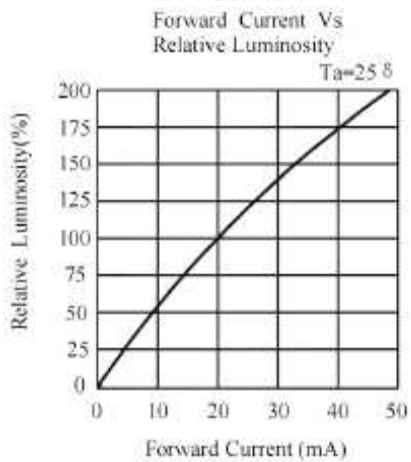
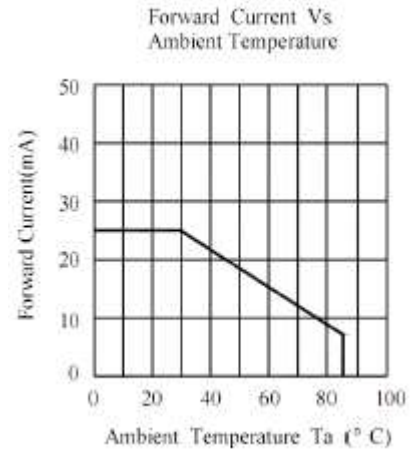
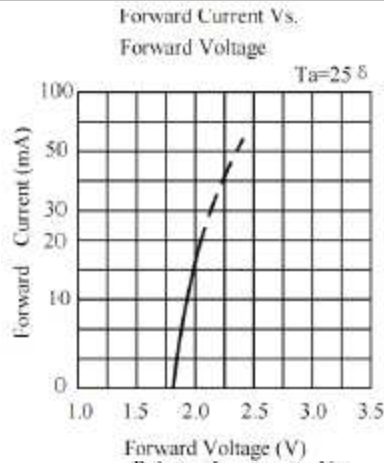
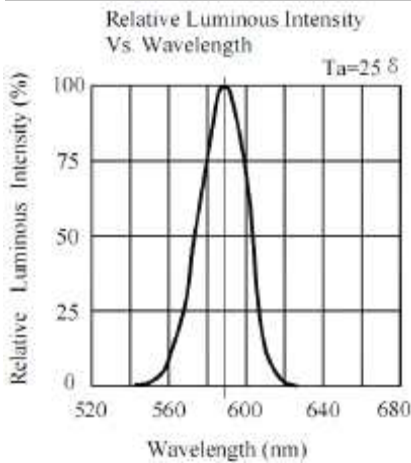

**CHIP LED FOR REVERSE PCB MOUNTING**

Part.No.	<b>M11B9018</b>
Customer	

DRW:	Harry	CHKD	Dustin	Tolerance	Tolerance:	Date:	05.11.2013
APPD:	Jason	MATL	Wilson	John	MASON	Sheet No.	3 from 6

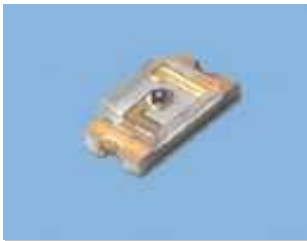

**Soldering condition for Lead solder**

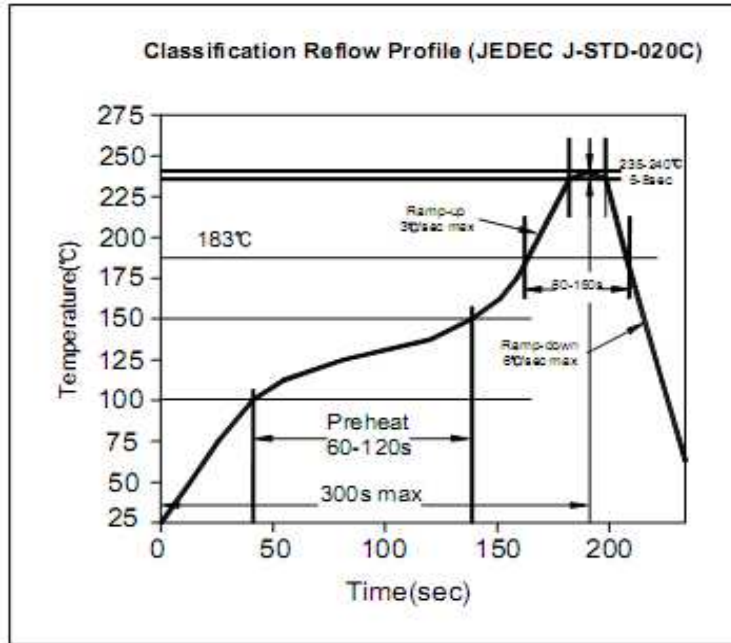

**Soldering condition for Lead free solder**

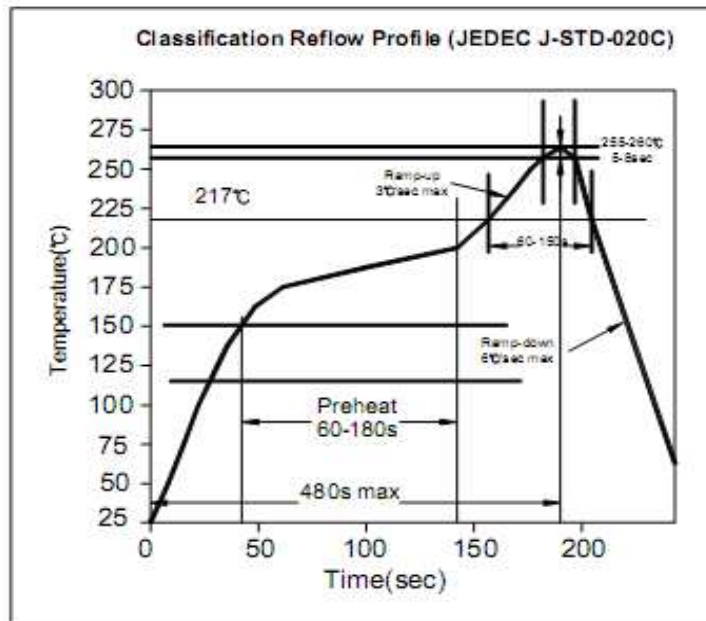

**CHIP LED FOR REVERSE PCB MOUNTING**

Part.No.	M11B9018
Customer	

DRW:	Harry	CHKD	Dustin	Tolerance	Tolerance:	Date:	05.11.2013
APPD:	Jason	MATL	Wilson	John	MASON	Sheet No.	4 from 6



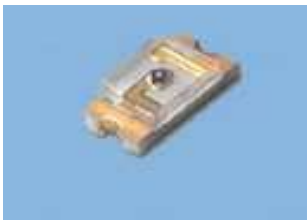

**Packing specification ( Antistatic Poly Bag )**

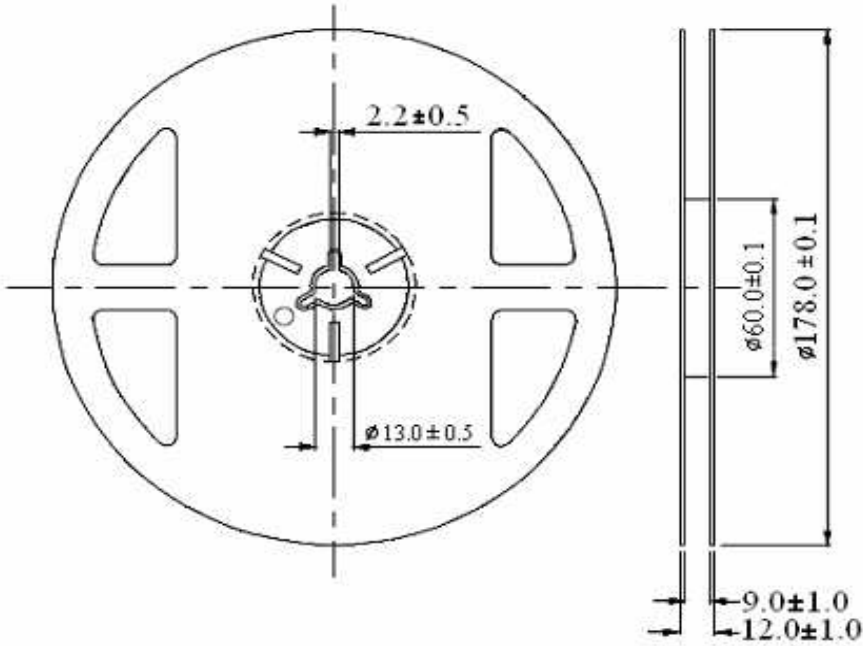

Unit: mm  
Tolerance: ± 0.25mm

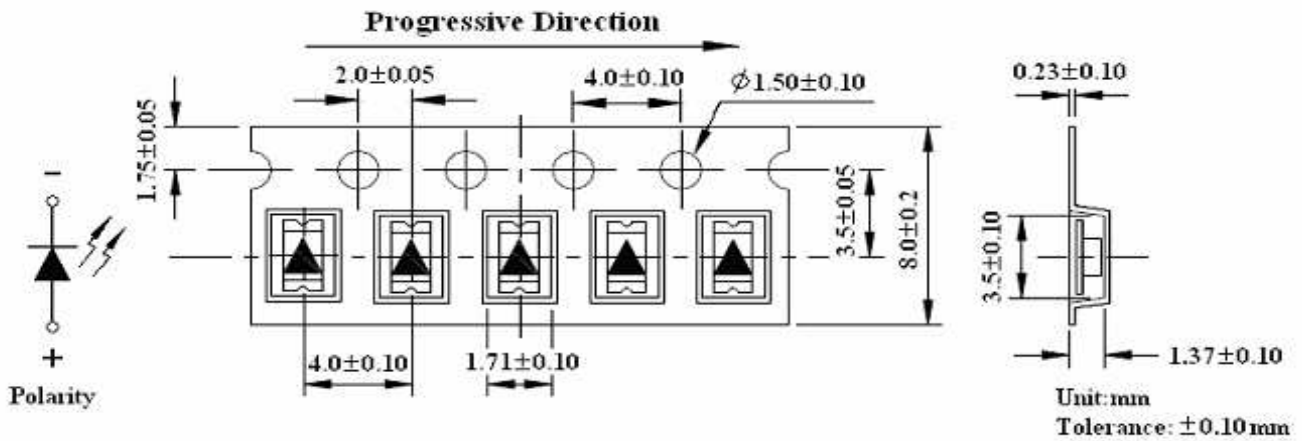

Unit: mm  
Tolerance: ± 0.10mm



Quantity of Reel ( 2000PCS Normal) other Packing Specifications available					<b>CHIP LED LED FOR REVERSE PCB MOUNTING</b>		
					Part.No.	<b>M11B9018</b>	
Customer							

DRW:	Harry	CHKD	Dustin	Tolerance	Tolerance:	Date:	05.11.2013
APPD:	Jason	MATL	Wilson	John	MASON	Sheet No.	5 from 6

[www.edcon-components.com](http://www.edcon-components.com)

email: [info@edcon-components.com](mailto:info@edcon-components.com)

Copyright by S.Tiede





**Color table curve**

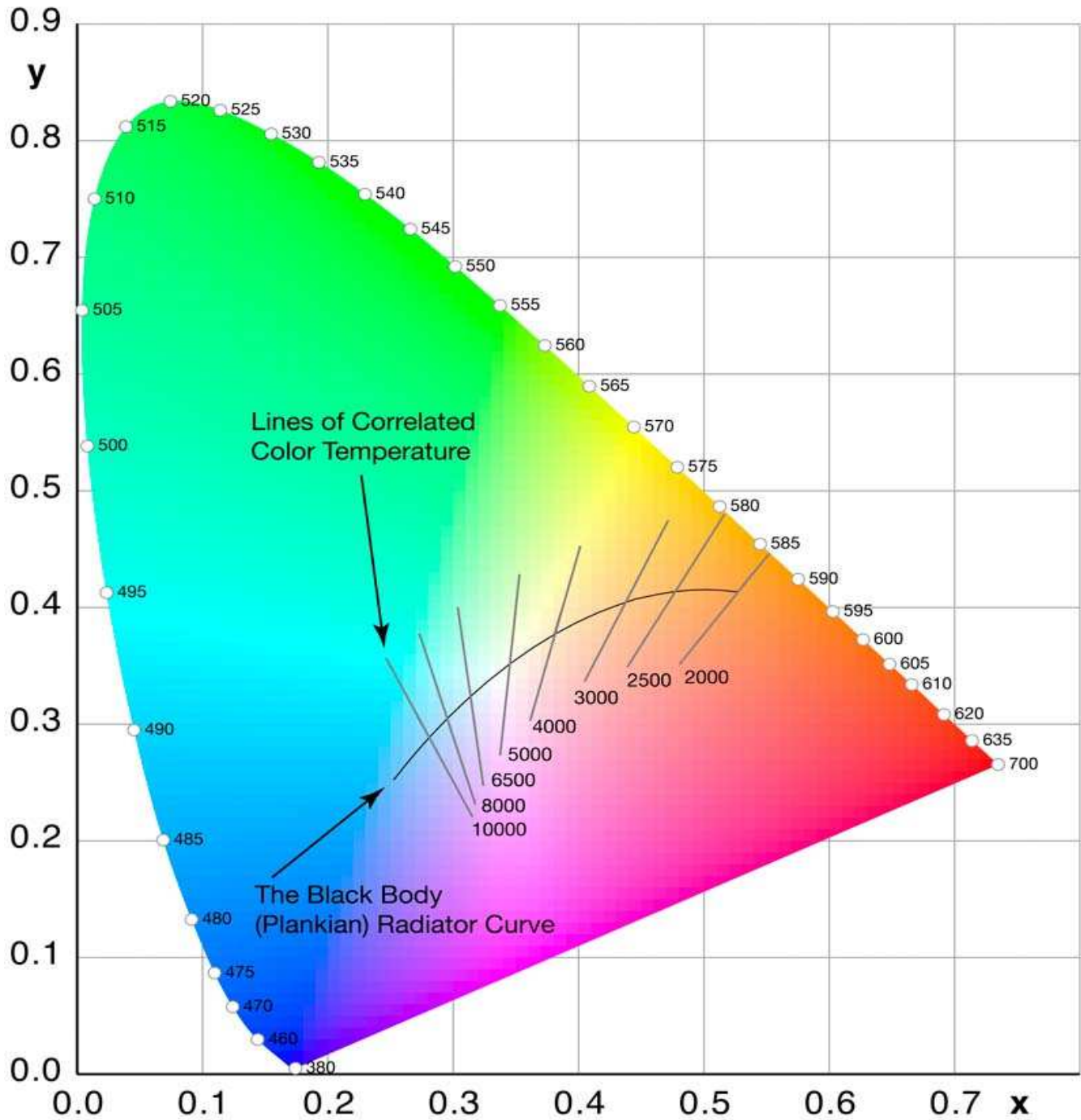

<b>CHIP LED LED FOR REVERSE PCB MOUNTING</b>	
Part.No.	<b>M11B9018</b>
Customer	

DRW:	Harry	CHKD	Dustin	Tolerance	Tolerance:	Date:	05.11.2013
APPD:	Jason	MATL	Wilson	John	MASON	Sheet No.	6 from 6